

Selection Guide.....	486
Miniature Switches & Pilot Devices.....	488
AP Series ø8-16mm.....	488
A8 Series ø8mm.....	492
ø16mm Switches & Pilot Devices.....	497
X6 E-Stops ø16mm.....	497
XA E-Stops ø16mm.....	501
LB Series ø16mm.....	508
L6 Series ø16mm.....	547
ø22mm Switches & Pilot Devices.....	569
XW E-Stops ø22mm.....	569
AP22M Series ø22mm.....	575
CW Series ø22mm.....	578
HW Series ø22mm.....	600
TW Series ø22mm.....	661
FB Series Enclosures.....	702
ø30mm Switches & Pilot Devices.....	704
XN E-Stops ø30mm.....	704
TWTD Series ø30mm.....	710
EU2B Series ø30mm.....	740
Cam Switches - CS Series.....	753
Mono-Lever Switches - ARN Switches.....	760

# Switches & Pilot Devices



[www.IDEC.com/switches](http://www.IDEC.com/switches)



Switches & Pilot Devices

Signaling Lights

Relays & Sockets

Timers

Contactors

Terminal Blocks

Circuit Breakers

**Selection Guide**

Appearance	Product Series	Mounting Hole	Contact Rating	Contact Mounting	Function	Page
	AP	ø8mm, ø10mm, ø12mm, ø16mm	N/A	N/A	Pilot light	488
	A8	ø8mm	1A	Unibody	Pushbutton, Pilot Light	492
	X6	ø16mm	5A	Unibody	E-Stop	497
	XA		5A	Removable/Unibody	E-Stop	501
	A6		1A	Unibody	Pushbutton, Pilot Light, Selector Switch, Key Switch, Stop Switch	<a href="http://www.IDEC.com/switches">www.IDEC.com/switches</a>
	LB	ø16mm	3A	Removable	Pushbutton, Pilot Light, Selector Switch, Key Switch, Lever Switch, Buzzer	508
	L6		5A	Removable	Pushbutton, Pilot Light, Selector Switch, Key Switch, Stop Switch, Buzzer	527
	XW		5A	Removable	E-Stop	569
	AP22M	ø22mm	N/A	Unibody	Pilot Lights	575
	CW		10A	Removable	Pushbutton, Pilot light, selector switch, key selector	578
	HW		10A	Removable	Pushbutton, Pilot Light, Selector Switch, Key Switch, E-Stop, Mono-Lever	600

Selection Guide con't

Appearance	Product Series	Mounting Hole	Contact Rating	Contact Mounting	Function	Page
	TW	ø22mm	10A	Removable	Pushbutton, Pilot Light, Selector Switch, Key Switch, Stop Switch	661
	FB		N/A	N/A	Enclosures	702
	XN	ø30mm	5A	Removable	E-Stop	704
	TWTD		10A	Removable	Pushbutton, Pilot Light, Selector Switch, Key Switch, Stop Switch	710
	CS		10A	Unibody	Cam Switch	753
	ARN	ø25mm, □ 25 x 25mm	10A	Removable	MonoLever	760
	LW Flush		5A	Removable	Pushbutton, Pilot Light, Selector Switch, Key Switch	<a href="http://www.IDEC.com/switches">www.IDEC.com/switches</a>

Switches & Pilot Devices

Signaling Lights

Relays & Sockets

Timers

Contactors

Terminal Blocks

Circuit Breakers

### AP Series – Miniature Pilot Lights

**Key features:**

- Long service life, low maintenance
- Space saving miniature style
- Dome or flat lens models
- Built-in current-limiting resistor
- Five illumination colors: red, green, amber, yellow, and white
- Transformer (120V AC and 240V AC) and DC-DC Converter (110V DC) options on 12mm and 16mm units



\*AP8/AP1 series only.

**Specifications**

Lamp	Built-in LED with current limiting resistor
Operational Voltage	5, 6, 12, 24VDC (full voltage), 110/120, 220/240VAC, (with transformer) 110VDC (with converter)
Current Ratings	AP8: 5V DC/9mA, 12V DC/9mA, 24V DC/9mA, 12V AC/15mA, 24V AC/15mA AP1: 5V DC/9mA, 12V DC/9mA, 24V DC/9mA, 12V AC/15mA, 24V AC/15mA AP2: 6V DC/33mA, 12V DC/22mA, 24V DC/11mA AP6: 6V DC/33mA, 12V DC/22mA, 24V DC/11mA
Operating Temp.	-20°C to +55°C
Operating Humidity	45 to 85% RH
Insul. Resistance	100MΩ min. (500V DC megger) Between live and dead parts
Rev. Withstand Voltage	AP2/AP6: 100V AP1/AP8: 200V
Solder Terminal	Soldering 260°C maximum (5 sec.)
Degree of Protection	AP8: IP40 (dustproof) Other Series: IP65 (oiltight)

**Optional Adaptors/Converters**

Model	Transformer	DC-DC Converter
Applicable Units	AP2 & AP6 (with 6V LED only)	
Operating Voltage	110/120VAC 50/60 Hz 220/240VAC 50/60 Hz	110V DC (90 to 140V DC)
Power Consumption	1.6 VA maximum	1W maximum
Insulation Voltage	250 V AC	140V DC
Insulation Resistance	10MΩ min. (500V DC megger) Between live and dead parts	
Dielectric Strength	2,000V AC, 1 minute Between live/dead parts 2,000V AC, 1 minute Between terminals	2,000V AC, 1 minute Between live/dead parts 1,500V AC, 1 minute Between terminals

Available as one piece only (replacement LEDs are not available).



### Miniature Pilot Lights

#### AP Miniature Pilot Lights - ø8 & ø10mm

Style	Lens Style	Operating Voltage	Part Numbers
AP8 Series - ø8mm	Dome	5V DC +/- 5% 12V AC/DC +/- 10% 24V AC/DC +/- 10%	AP8M255-Ⓞ AP8M211-Ⓞ AP8M222-Ⓞ
	Flat	5V DC +/- 5% 12V AC/DC +/- 10% 24V AC/DC +/- 10%	AP8M155-Ⓞ AP8M111-Ⓞ AP8M122-Ⓞ
AP1 Series - ø10mm	Dome	5V DC +/- 5% 12V AC/DC +/- 10% 24V AC/DC +/- 10%	AP1M255-Ⓞ AP1M211-Ⓞ AP1M222-Ⓞ
	Flat	5V DC +/- 5% 12V AC/DC +/- 10% 24V AC/DC +/- 10%	AP1M155-Ⓞ AP1M111-Ⓞ AP1M122-Ⓞ

#### Ⓞ Color Codes

Color	Code
Amber	A
Green	G
Red	R
Blue	S*
Warm White	W
Cool White	PW
Yellow	Y

\* Available in only the AP8 and AP1 series.

- 1. In place of Ⓞ, specify the color code.
- 2. For dimensions, see page 491.
- 3. For accessories, see page 490.

#### AP Miniature Pilot Lights - ø12 & ø16mm

Style	Lens Style	Operating Voltage	Part Numbers
AP2 Series - ø12mm	Dome	6V DC +/- 5% 12V DC +/- 10% 24V DC +/- 10%	AP2M266-Ⓞ AP2M211-Ⓞ AP2M222-Ⓞ
	Flat	6V DC +/- 5% 12V DC +/- 10% 24V DC +/- 10%	AP2M166-Ⓞ AP2M111-Ⓞ AP2M122-Ⓞ
AP6 Series - ø16mm	Dome	6V DC +/- 5% 12V DC +/- 10% 24V DC +/- 10%	AP6M266-Ⓞ AP6M211-Ⓞ AP6M222-Ⓞ
	Flat	6V DC +/- 5% 12V DC +/- 10% 24V DC +/- 10%	AP6M166-Ⓞ AP6M111-Ⓞ AP6M122-Ⓞ

#### Ⓞ Color Codes

Color	Code
Amber	A
Green	G
Red	R
Warm White	W
Yellow	Y

- 1. In place of Ⓞ, specify the color code.
- 2. For dimensions, see page 491.
- 3. For accessories, see page 490.





#### Optional Transformers and DC-DC Converters (for AP2 and AP6 only)

Style	Voltage	Part Numbers		
		Used with AP2 Series	Used with AP6 Series	
	Transformer	110/120V AC 220/240V AC	AP2-0126D AP2-0246D	AP6-0126D AP6-0246D
	DC-DC Converter	110V DC (90-140V DC)	AP2-016DD	AP6-016DD

- 1. Optional Transformers and DC-DC converters snap onto the back of AP2 or AP6 pilot lights.
- 2. Transformers and DC-DC Converters step down to 6V.
- 3. For dimensions, see page 491.

Switches & Pilot Devices

**Accessories – AP Series**

Item	Appearance	Description	Used With	Part Number
Locking Ring Wrench		Made of metal. Used for tightening plastic locking ring during installation. Tightening torque should not exceed 3kgf-cm	Ø 16mm units	MT-001
			Ø 12mm units	MT-002
			Ø 10mm units	MT-003
			Ø 8mm units	MT-004
Mounting Hole Plug		Made of rubber. Fills unused mounting holes to provide IP65 protection	Unused 8mm panel cutouts	AL-B8
			Unused 10mm panel cutouts	AL-B1
			Unused 12mm panel cutouts	AL-B2
			Unused 16mm panel cutouts	AL-B6
Transformer Removal Tool		A Series Blank/Lens Removal Tool	AP2 and AP6 snap on transformer and DC-DC converter	MT-100
Replacement Lenses		Lenses (included with all units).	AP1M Flat	AP1M-L1-Ⓞ
			AP1M Dome	AP1M-L2-Ⓞ
			AP2M Flat	AP2M-L1-Ⓞ
			AP2M Dome	AP2M-L2-Ⓞ
			AP6M Flat	AP6M-L1-Ⓞ
			AP6M Dome	AP6M-L2-Ⓞ

Signaling Lights

Relays & Sockets

-  1. In place of Ⓞ, specify the Lens Color Code.
- 2. Internal LED is fixed and cannot be removed or replaced.

**Ⓞ Lens Color Codes**

Color	Code
Amber	A
Green	G
Red	R
Blue	S*
White	W
Yellow	Y

Timers

 \*Blue available in AP8/AP1 series only.

Contactors

Terminal Blocks

Circuit Breakers

Dimensions – AP Series

Pilot Lights (AP Series)

Style	AP8		AP1		AP2			AP6		
	Flat	Dome	Flat	Dome	Flat	Dome	w/ Adaptor or Converter	Flat	Dome	w/ Adaptor or Converter
Panel Cut-out	Ø 0.319" (+0.0118, -0) 8.1mm (+0.3, -0)		Ø 0.398" (+0.0118, -0) 10.1mm (+0.3, -0)		Ø 0.480" (+0.0118, -0) 12.2mm (+0.3, -0)			Ø 0.638" (+0.0118, -0) 16.2mm (+0.3, -0)		
Outside Dimension	Ø 0.386" (9.8mm)		Ø 0.472" (12mm)		Ø 0.551" (14mm)		□ 0.709" (18mm)	Ø 0.709" (18mm)		□ 0.709" (18mm)

AP6

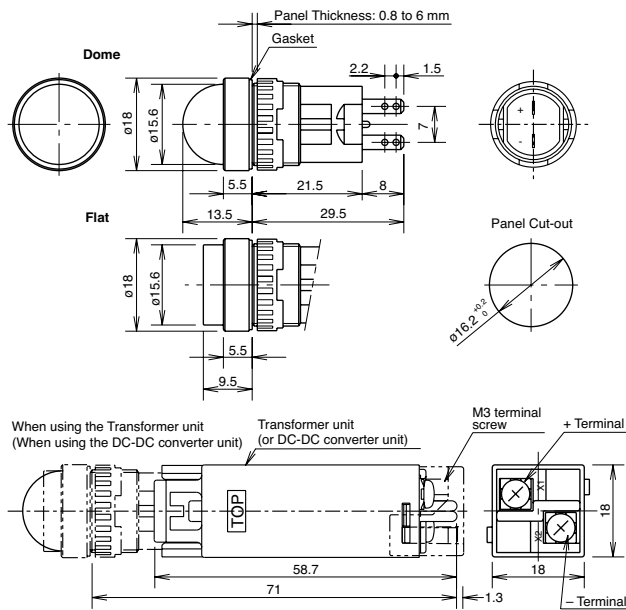

AP2

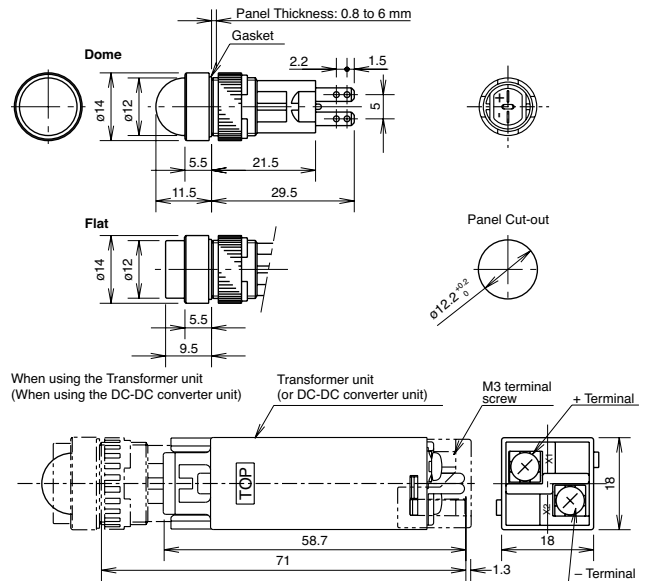

AP1

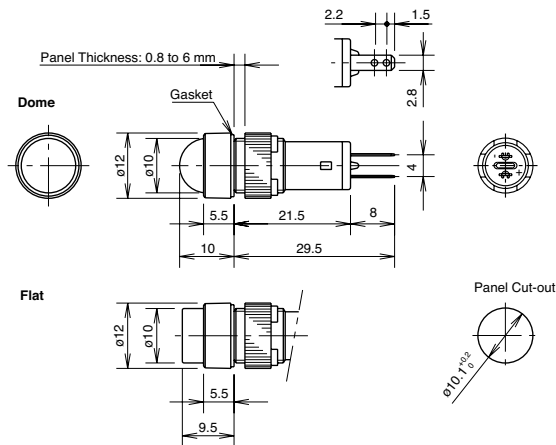

AP8

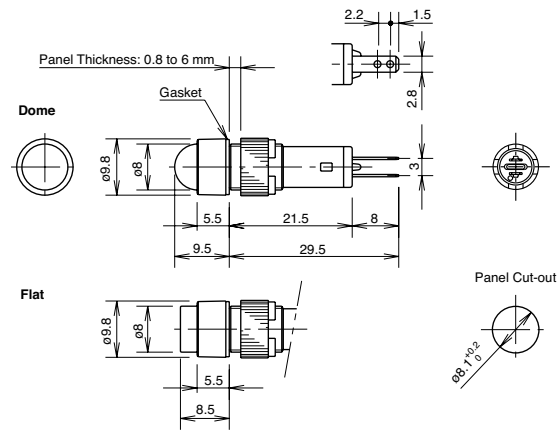

Switches & Pilot Devices

Signaling Lights

Relays & Sockets

Timers

Contactors

Terminal Blocks

Circuit Breakers

**A8 Series — Miniature Switches and Pilot Devices: 8mm**

**Key features:**

- 21/64" (8mm) round mounting hole
- Compact Design Saves Space
- Bright and Vivid Illumination
- Choice of Shapes and Functions
- Gold Clad Silver Contacts for reliable low level switching
- Snap action contacts
- IP40 (Dustproof) Construction



**Specifications**

LED Lamp Life	50,000 hours approximately (reduced to half of original intensity)
Contact Configuration	SPDT
Maximum Voltage	250V AC/DC
Thermal Current	3A
Contact Material	Gold-clad Silver
Terminal Style	Solder Tab Terminal
Operating Temperature	-25° to +55°C (no freezing)
Operating Humidity	45 to 85% RH
Contact Resistance	50mΩ maximum (initial value)
Insulation Resistance	100MΩ minimum (500V DC megger)
Vibration Resistance	5 to 55Hz, 0.75mm amplitude
Shock Resistance	Damage limits: 500m/sec <sup>2</sup> (approx. 50G) Operating extremes: 200m/sec <sup>2</sup> (approx. 20G)
Electrical Life	100,000 operations minimum
Mechanical Life	Maintained: 100,000 (1200 operations/hour) Momentary: 200,000 minimum
Degree of Protection	IP40 Enclosed/Dustproof
Soldering Temperature	20W/5 seconds or 260°C/3 seconds
Dielectric Strength	Switch Unit: 2,000V AC, 1 min. between live/dead part and terminals of different poles; 1,000V AC, 1 minute between terminals of the same pole; 1,500V AC, 1 minute between contact and lamp terminals. Illumination Unit: 2,000V AC, 1 min. between live part/ground

**Contact Ratings**

Operating Voltage		24V	120V	240V
AC 50/60Hz	Resistive	—	1.0A	0.5A
	Inductive	—	0.7A	0.5A
DC	Resistive	1.0A	0.2A	—
	Inductive	0.7A	0.1A	—

1. AC Inductive Load, PF = 0.6 – 0.7; DC Inductive Load, L/R = 7.
2. Minimum applicable load (reference value) is 5V AC/DC 3mA (applicable range is subject to the operating conditions and load).

Switches & Pilot Devices

Signaling Lights

Relays & Sockets

Timers

Contactors

Terminal Blocks

Circuit Breakers

**AB8 Non-Illuminated Pushbuttons (Assembled)**

**Non-Illuminated Pushbuttons**

Style	Contact	Part Numbers	
		Momentary	Maintained
Round 	SPDT	AB8M-M1-⓪	AB8M-A1-⓪
Square 	SPDT	AB8Q-M1-⓪	AB8Q-A1-⓪
Rectangular 	SPDT	AB8H-M1-⓪	AB8H-A1-⓪

⓪ **Button Color Codes**

Color	Code
Black	B
Green	G
Red	R
Blue	S
White	W
Yellow	Y

- 1. In place of ⓪, specify button color code from the table below.
- 2. For accessories, see page 495.
- 3. For dimensions, see page 496.

AL8 Illuminated Pushbuttons & Pilot Lights (Assembled)

Illuminated Pushbuttons

Style	Contact	Part Numbers		Pilot Light Part Number
		Momentary	Maintained	
Round 	SPDT	AL8M-M11-Ⓞ	AL8M-A11-Ⓞ	AL8M-P1-Ⓞ
Square 	SPDT	AL8Q-M11-Ⓞ	AL8Q-A11-Ⓞ	AL8Q-P1-Ⓞ
Rectangular 	SPDT	AL8H-M11-Ⓞ	AL8H-A11-Ⓞ	AL8H-P1-Ⓞ

Ⓞ LED/Lens Color Codes

Color	Code
Amber	A
Green	G
Red	R
White	W
Yellow	Y

- In place of Ⓞ, specify lens color code from table on the right.
- A replaceable LED lamp is included with the operator.
- Because the LED lamp does not contain an internal current limiting resistor, an external resistor must be added. For recommended values, see table below.
- For accessories, see page 495.
- For dimensions, see page 496.

Replacement LEDs

Lens Color	LED Lamp	Part Number
Amber	Amber	LAD-SA
Green	Green	LAD-SG
Red	Red	LAD-SR
White	Yellow*	LAD-SY
Yellow	Yellow	LAD-SY

\* White units use a white lens and a yellow LED.

LED Voltage and Recommended Current Limiting Resistor

Voltage	External Resistor
5V DC	150Ω, 1/2W
6V DC	200Ω, 1/2W
12V DC	510Ω, 1W
24V DC	1.1kΩ, 1W

LED Lamp Ratings: LED Specifications

LED Lamp	Forward Current $I_f$	Forward Voltage (Nominal) $V_f$	Reverse Voltage $V_r$	Operating Voltage & External Current Limiting Resistor (Recommended Value)
Amber	20mA	2.2V	4V	5V DC: 150Ω, 1/2W 6V DC: 200Ω, 1/2W 12V DC: 510Ω, 1W 24V DC: 1.1kΩ, 1W
Green	20mA	2.1V	4V	
Red	20mA	1.7V	4V	
Yellow	20mA	2.2V	4V	

When LED lamps are used at voltages other than those stated above, external resistor value, R, is determined by the following formula:  $R = (Operating\ Voltage - V_f) / I_f$

Accessories

Item	Description	Used With	Part Number
 <p>Locking Ring Wrench</p>	Made of metal. Used for tightening plastic locking ring during installation. Tightening torque should not exceed 3kgf-cm	All units	MT-004
 <p>Lens Removal Tool</p>	Made of metal. Used for removing lens or button from the housing	Illuminated pushbuttons and pilot lights	MT-101
 <p>Lamp Holder Tool</p>	Made of rubber. Used for removing and replacing LED lamps in illuminated units	Illuminated pushbuttons and pilot lights	OR-66
 <p>Switch Guard</p>	Used to avoid operating the pushbutton inadvertently. Cover flips open 90°. Provides IP40 protection	Round & square units	AL-K8
		Rectangular units	AL-KH8
 <p>Terminal Cover</p>	Made of translucent nylon. Fits over and shields the terminals	All units	AL-V8
 <p>Adaptor Socket</p> <p>AL-C8 AL-C8V shown attached</p>	Plug-on adaptor with solder terminals, allows easy control unit replacement. Plug-on adaptor with PCB terminals, allows easy control unit replacement.	All units	AL-C8
			AL-C8V
 <p>Mounting Hole Plug</p>	Made of rubber. Fills unused mounting holes to provide IP65 protection	Extra panel cutouts	AL-B8
 <p>Replacements LEDs</p>	LED lamp is included in every illuminated control unit. Replacement lamp is ordered separately. External current limiting resistor required.	Illuminated units and pilot lights	LAD-SR (red)
			LAD-SG (green)
			LAD-SA (amber)
			LAD-SY (yellow)
 <p>Replacement Lenses</p>		Illuminated pushbuttons and pilot lights	Round AL8M-LK1-②
			Square AL8Q-LK1-②
			Rectangular AL8H-LK1-②
 <p>Replacement Buttons</p>		Non-Illuminated buttons	Round AB8M-BK1-①
			Square AB8Q-BK1-①
			Rectangular AB8H-BK1-①

- 1. In place of ①, specify Button Color Code from the table.
- 2. In place of ②, specify Lens Color Code from table.

① Button Color Codes

Color	Code
Black	B
Green	G
Red	R
Blue	S
White	W
Yellow	Y

② LED/Lens Color Codes

Color	Code
Amber	A
Green	G
Red	R
White	W
Yellow	Y



Dimensions

AΔ8

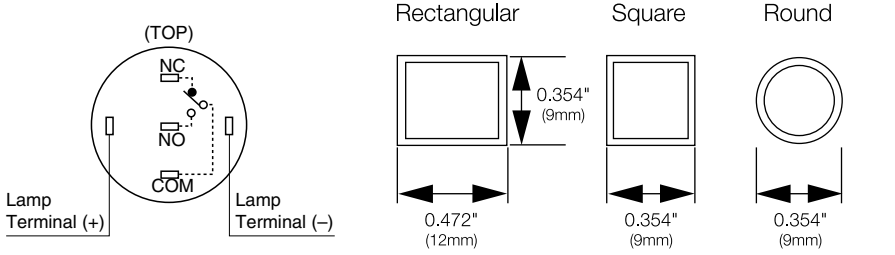
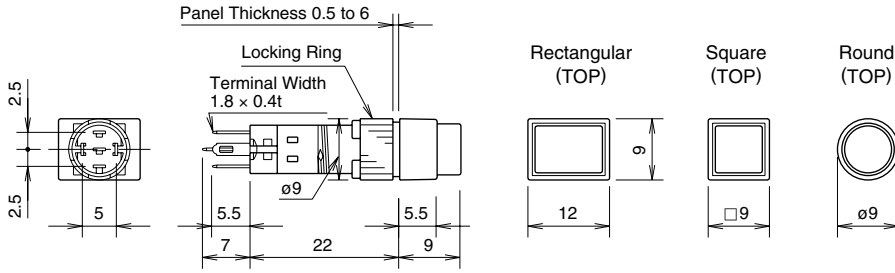

Panel Cut-Out (not drawn to scale)  
Rectangular

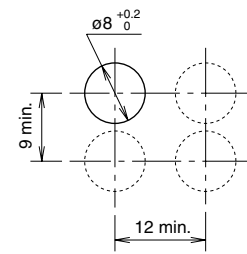

Round/Square

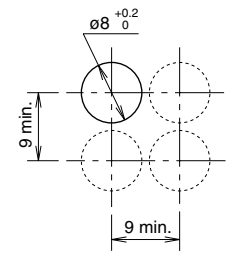

Terminal Sockets

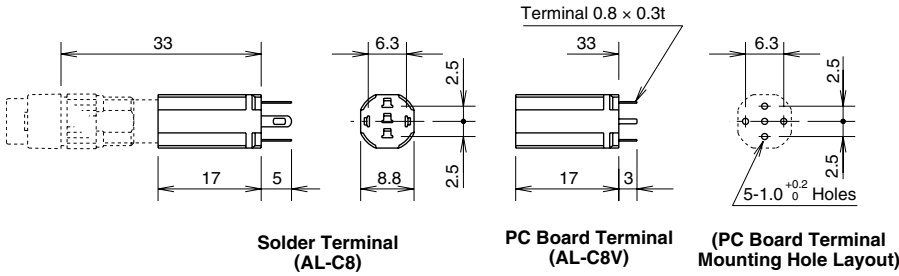

Terminal Arrangement (TOP)

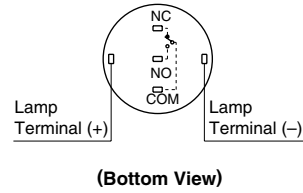

Switch Guard, Ø 21/64" (8mm)

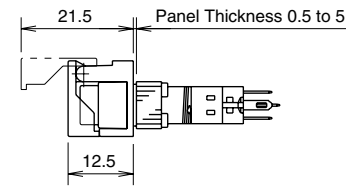

For Round/Square Units (AL-K8)

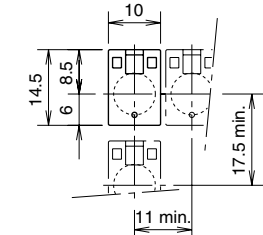

For Rectangular Units (AL-KH8)

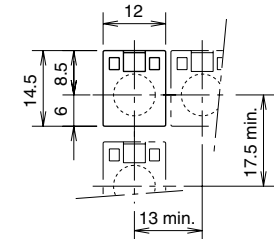

Terminal Cover

AL-V8, Ø 21/64" (8mm)

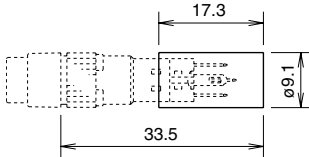

16mm X6 E-Stops

Key features:

- Two button sizes—ø30mm and ø40mm
- Two button colors—red for emergency stop and yellow for stop switch
- Two ways of resetting —pulling and turning
- Solder/tab terminal #110 makes for easy connections
- UL, c-UL recognized, EN compliant
- Safety lock mechanism (IEC 60947-5-5; 6.2)
- Direct opening action (IEC 60947-5-5; 5.2, IEC 60947-5-1, Annex K)



Specifications

Applicable Standards	IEC 60947-5-1, EN 60947-5-1 IEC 60947-5-5 (Note), EN 60947-5-5 (Note) JIS C8201-5-1, JIS C8201-5-5, UL508 CSA C22.2 No.14, GB14048.5
Operating Temperature	-25 to +60°C (no freezing)
Operating Humidity	45 to 85% RH (no condensation)
Storage Temperature	-45 to +80°C (no freezing)
Operating Force	Push to lock: 10.5N, Pull to reset: 8.8N, Turn to reset: 0.17 N·m
Minimum Force Required for Direct Opening Action	40N
Minimum Operator Stroke Required for Direct Opening Action	4.5mm
Maximum Operator Stroke	4.5mm
Contact Resistance	50mΩ maximum (initial value)
Insulation Resistance	100MΩ minimum (500V DC megger)
Overvoltage Category	II
Impulse Withstand Voltage	2.5kV
Pollution Degree	3
Operation Frequency	900 operations/hour
Shock Resistance	Operation extremes: 150 m/s <sup>2</sup> , Damage limits: 1000 m/s <sup>2</sup>
Vibration Resistance	Operation extremes: 10 to 500 Hz amplitude 0.35 mm, acceleration 50 m/s <sup>2</sup> Damage limits: 10 to 500 Hz, amplitude 0.35 mm, acceleration 50 m/s <sup>2</sup>
Mechanical Life	100,000 operations minimum
Electrical Life	100,000 operations minimum
Degree of Protection	IP65 (IEC 60529)
Short-circuit Protection	250V/10A fuse (Type aM IEC 60269-1/IEC 60269-2)
Conditional Short-circuit Current	1000A
Terminal Style	Solder/tab terminal #110
Recommended Tightening Torque for Locking Ring	0.88N·m
Applicable Wire Size	1.25mm <sup>2</sup> maximum (AWG16 maximum)
Terminal Soldering Condition	310 to 350°C, within 3 seconds
Weight (approx.)	ø30mm button: 13g, ø40mm button: 16g

Contact Ratings

Rated Insulation Voltage (Ui)		250V				
Rated Thermal Current (Ith)		5A				
Rated Operating Voltage (Ue)		30V	125V	250V		
Rated Operating Current (Note)	Main Contacts	AC 50/60 Hz	Resistive Load (AC-12)	-	5A	3A
			Inductive Load (AC-15)	-	1.5A	0.75A
	DC		Resistive Load (DC-12)	2A	0.4A	0.2A
			Inductive Load (DC-13)	1A	0.22A	0.1A





- Minimum applicable load: 5V AC/DC, 1mA (reference value) (May vary depending on the operating conditions and load)
- Operational current represents the classification by making and breaking currents (IEC 60947-5-1)
- TÜV rating: AC-15 0.75A/250V, DC-13 1A/30V  
UL rating: Standard Duty AC 0.75A/250V  
Standard Duty DC 1A/30V



Except for stop switch (yellow button)

Part Numbers

Pushlock Pull/Turn Reset Switch (Unmarked)

Shape	Main Contact (NC)	Part Number
		Solder/tab Terminal #110
 ø30mm Mushroom	1NC	AB6E-3BV01PTRH
	2NC	AB6E-3BV02PTRH
 ø40mm Mushroom	1NC	AB6E-4BV01PTRH
	2NC	AB6E-4BV02PTRH

Pushlock Pull/Turn Reset Switch (Marked with Arrow)

Shape	Main Contact (NC)	Part Number
		Solder/tab Terminal #110
 ø30mm Mushroom	1NC	AB6E-3BV01PTRM
	2NC	AB6E-3BV02PTRM
 ø40mm Mushroom	1NC	AB6E-4BV01PTRM
	2NC	AB6E-4BV02PTRM

Yellow Button, Pushlock Pull/Turn Reset Switch (Unmarked)

Shape	Operator	Main Contact (NC)	Part Number
		Solder/tab Terminal #110	
 ø30mm Mushroom	ø30mm button	1NC	AB6E-3BV01PTY
		2NC	AB6E-3BV02PTY
	ø40mm button	1NC	AB6E-4BV01PTY
		2NC	AB6E-4BV02PTY

Accessories

Shape	Material	Part Number	Remarks
 Locking Ring Wrench	Metal (nickel-plated brass)	MT-001	Used to tighten the locking ring when installing the X6 switch onto a panel. Recommended tightening torque: 0.88 N·m maximum
 Locking Ring	Plastic	XA9Z-LNPN10	Black
 SEMI S2 Compliant Switch Guard	Polyamide (PA6)	XA9Z-KG1	IP65 degree of protection Color: yellow (Munsell 2.5Y8/10 or equivalent) Cannot be used with nameplate.

1. Pushlock pull/turn reset switches are locked when pressed, and reset when pulled or turned clockwise.
2. Do not use the stop switch as an emergency stop switch.

Part Number Key

**AB6E - 3 BV 01 PT RH**

Mushroom Size: 3: ø29mm, 4: ø40mm  
 Contact Configuration: 01: 1NC, 02: 2NC  
 Color/Marking: RH: Red (unmarked), RM: Red (marked with arrow), Y: Yellow (unmarked)

Nameplates

Use With	Description	Legend	Part Number	Material	Background Color	Legend Color
E-Stops	For ø30mm Button	Blank	HAAV-0	Polyamide	Yellow	Black
		EMERGENCY STOP	HAAV-27			
	For ø40mm Button	Blank	HAAV4-0			
		EMERGENCY STOP	HAAV4-27			
Stop Switch	For ø30mm Button	Blank	HAAV-0-W	White (Munsell N9.5)		
	For ø40mm Button		HAAV4-0-W			

 Cannot be used with switch guard.

Dimensions (mm)

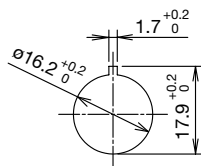
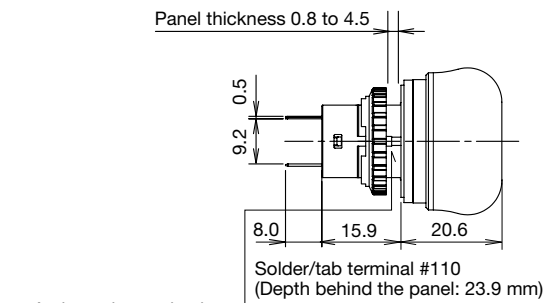

Mounting Hole Layout

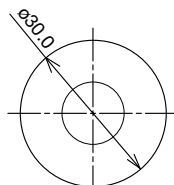
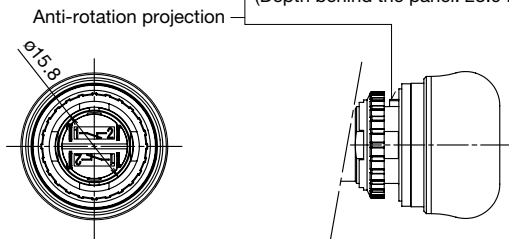

Unmarked

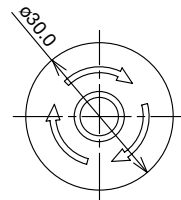

Arrow Marked

ø30mm Button

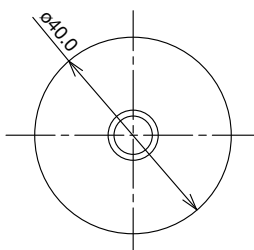
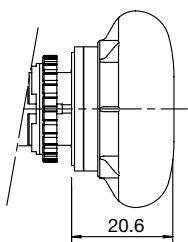

Unmarked

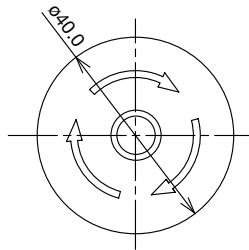

Arrow Marked

ø40mm Button

Nameplate for ø30mm Button HAAV-\*

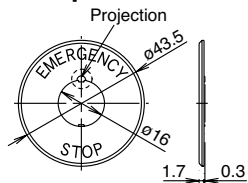

Nameplate for ø40mm Button HAAV4-\*

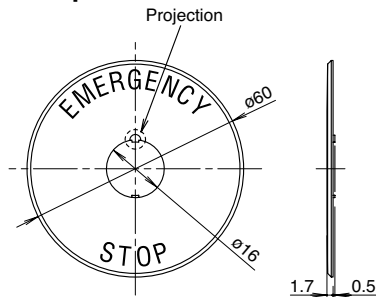

Switch Guard XA9Z-KG1

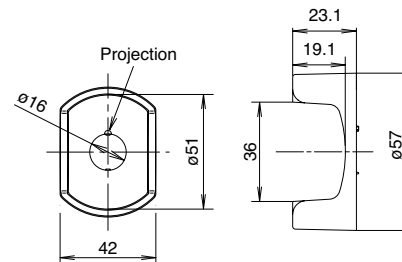

Mounting Hole Layout

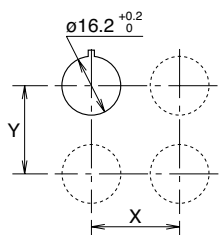

The values shown on the left are the minimum dimensions for mounting with other ø16 mm pushbuttons. For other control units of different sizes and styles, determine the values according to dimensions, operation, and wiring.

	X	Y
ø30 mm Button	40 mm min.	40mm min.
ø40 mm Button	50 mm min.	50mm min.

Terminal Arrangement (Bottom View)

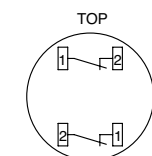

1NC type: Terminals located near the TOP marking

### Safety Precautions

- Turn off power to the X6 series units before installation, removal, wiring, maintenance, and inspection. Failure to turn power off may cause electrical shocks or fire hazard.
- For wiring, use wires of proper size to meet the voltage and current requirements and solder properly. Improper soldering may cause overheating and create fire hazards.

### Instructions

#### Panel Mounting

Remove the locking ring from the operator and check that the rubber gasket is in place. Insert the operator from panel front into the panel hole. Face the side with the projection upward, and tighten the locking ring using the locking ring wrench MT-001.

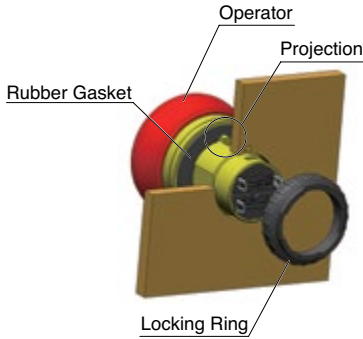

#### Notes for Panel Mounting

Using the locking ring wrench MT-001, tighten the locking ring to a torque of 0.88 N·m. Do not use pliers. Do not apply excessive force, otherwise the locking ring will become damaged.

#### Contact Bounce

When the button is reset by pulling or turning, the NC contacts will bounce. When designing a control circuit, take the contact bounce time into consideration (reference value: 20ms).

Do not apply any external shock to the emergency stop switches, otherwise the contact will bounce.

#### Handling

Do not expose the switch to excessive shock and vibrations, otherwise the switch may be deformed or damaged, causing malfunction or operation failure.

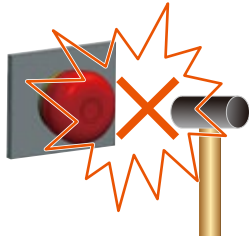

#### Wiring

1. Applicable wire size is 1.25mm<sup>2</sup> (16 AWG) maximum.
2. Solder the terminals using a soldering iron at 310 to 350°C for 3 seconds maximum. Do not use flow or dip soldering. SnAgCu type lead-free solder is recommended. Make sure that the soldering iron touches the terminals only, not any plastic parts. Do not apply external force (bending the terminals or applying tensile force on the wires).
3. Use a non-corrosive rosin flux. To prevent the flux from entering the switch while soldering, angle the terminals downward.

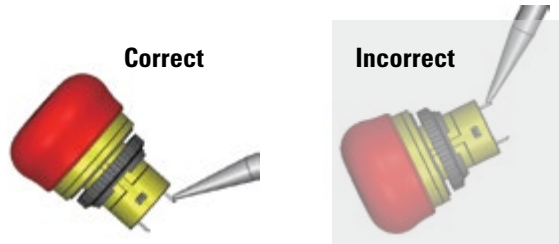

4. Because the terminal spacing is narrow, use protective tubes or heat shrinkable tubes to avoid burning the wire sheath or causing a short circuit.
5. Apply force on the terminals in the vertical direction to the panel only, otherwise the terminals will be damaged.
6. When using tab connectors, specify quick connect #110 and 0.5mm tab thickness.

## 16mm XA E-Stops

## Key features:

- Two button sizes: ø29 and ø40mm
- Lead-free, RoHS compliant, (EU directive 2002/95/EC)
- Depth behind the panel:  
Standard - only 27.9mm for 1 to 4 contacts  
Unibody - only 23.9mm for 1NC or 2NC
- IDEC's original "Safe break action" ensures that the NC contacts open when the contact block is detached from the operator.
- Push-to-lock, Pull or Turn-to-reset operator
- Direct opening action mechanism (IEC60947-5-5, 5.2, IEC60947-5-1, Annex K)
- Safety lock mechanism (IEC60947-5-5, 6.2)
- Degree of protection:  
Standard - IP65 (IEC60529)  
Unibody - IP65 and IP40 (IEC 60529)
- UL, c-UL recognized. EN compliant
- UL NISD2 category emergency stop button (File# E305148)



CCC No. 2005010305150899

## Specifications



Model	Standard	Unibody
Applicable Standards	IEC60947-5-1, EN60947-5-1, IEC60947-5-5, EN60947-5-5, UL508, UL991, CSA C22.2 No. 14	UL508, CSA C22.2 No.14, IEC 60947-5-1, EN 60947-5-1 IEC 60947-5-5 <sup>Note</sup> , EN 60947-5-5 <sup>Note</sup> , JIS C8201-5-1
Operating Temperature	Non-illuminated: -25 to +60°C (no freezing), Illuminated: -25 to +55°C (no freezing)	-25 to +60°C (no freezing)
Operating Humidity	45 to 85% RH (no condensation)	
Storage Temperature	-45 to +80°C	
Operating Force	Push-to-lock: 10.5N   Pull-to-reset: 10N   Turn-to-reset: 0.16N·m	
Minimum Force Required for Direct Opening Action	60N	40N
Min Operator Stroke Required for Direct Opening Action	4mm	
Maximum Operator Stroke	4.5mm	
Contact Resistance	50mΩ maximum (initial value)	
Contact Material	Gold plated silver	
Insulation Resistance	100MΩ minimum (500V DC megger)	
Impulse Withstand Voltage	2.5kV	
Pollution Degree	3 (inside LED unit: 2)	3
Operation Frequency	900 operations/hour	
Shock Resistance	Operating extremes: 150 m/s <sup>2</sup> , Damage limits: 1000 m/s <sup>2</sup>	
Vibration Resistance	Operating extremes: 10 to 500Hz, amplitude 0.35mm acceleration 50m/s <sup>2</sup> , Damage limits: 10 to 500Hz, amplitude 0.35mm acceleration 50m/s <sup>2</sup>	
Mechanical Life	250,000 operations minimum	
Electrical Life	100,000 operations minimum, (250,000 operations minimum @ 24V AC/DC, 100mA)	
Degree of Protection	IP65 (IEC60529)	IP65, IP40 (IEC 60529)
Terminal Style	Solder terminal, PC board terminal	Solder/tab #110 terminal
Recommended Tightening Torque for Locking Ring	0.88N·m	
Wire Size	16 AWG max	
Soldering Conditions	310 to 350°C, 3 seconds maximum	
Weight	ø29mm: 23g ø40mm: 28g	ø29mm mushroom: 14g ø40mm mushroom: 17g





Note: Except for stop switches (operator color: yellow and gray)

Part Numbers

Non-Illuminated XA E-Stop

Style	Termination	Monitor Contacts	Main Contacts	Part Number
 29mm Mushroom	PCB Terminal	1NO	1NC	XA1E-BV311V-R
		-	2NC	XA1E-BV302V-R
		1NO	3NC	XA1E-BV313V-R
		-	4NC	XA1E-BV304V-R
	Solder Terminal	1NO	1NC	XA1E-BV311-R
		-	2NC	XA1E-BV302-R
		1NO	3NC	XA1E-BV313-R
		-	4NC	XA1E-BV304-R
 40mm Mushroom	PCB Terminal	1NO	1NC	XA1E-BV411V-R
		-	2NC	XA1E-BV402V-R
		1NO	3NC	XA1E-BV413V-R
		-	4NC	XA1E-BV404V-R
	Solder Terminal	1NO	1NC	XA1E-BV411-R
		-	2NC	XA1E-BV402-R
		1NO	3NC	XA1E-BV413-R
		-	4NC	XA1E-BV404-R

Illuminated XA E-Stop

Style	Termination	Monitor Contacts	Main Contacts	Part Number
 29mm Mushroom	PCB Terminal	1NO	1NC	XA1E-LV311Q4V-R
		-	2NC	XA1E-LV302Q4V-R
		1NO	3NC	XA1E-LV313Q4V-R
		-	4NC	XA1E-LV304Q4V-R
	Solder Terminal	1NO	1NC	XA1E-LV311Q4-R
		-	2NC	XA1E-LV302Q4-R
		1NO	3NC	XA1E-LV313Q4-R
		-	4NC	XA1E-LV304Q4-R
 40mm Mushroom	PCB Terminal	1NO	1NC	XA1E-LV411Q4V-R
		-	2NC	XA1E-LV402Q4V-R
		1NO	3NC	XA1E-LV413Q4V-R
		-	4NC	XA1E-LV404Q4V-R
	Solder Terminal	1NO	1NC	XA1E-LV411Q4-R
		-	2NC	XA1E-LV402Q4-R
		1NO	3NC	XA1E-LV413Q4-R
		-	4NC	XA1E-LV404Q4-R



All illuminated XA E-Stops come with a replaceable 24V AC/DC LED.

Part Number Key

**XA1E - L V 3 11 Q4 V - R**

**Illumination**  
 B: Non-Illuminated  
 L: Illuminated

**Contact Configuration**  
 11: 1NO - 1NC  
 02: 2NC  
 13: 1NO - 3NC  
 04: 4NC



**Terminal**  
 Blank: solder tab  
 V: PCB

**Mushroom Size**  
 3: ø29mm  
 4: ø40mm

**Voltage Code**  
 Blank: Non-illuminated  
 Q4: Illuminated 24V AC/DC



**Unibody XA E-Stop**

Style	Contact	Part Number	
		IP40 (black housing)	IP65 (yellow housing)
29mm Mushroom 	1NC	XA1E-BV3U01KT-R	XA1E-BV3U01T-R
	2NC	XA1E-BV3U02KT-R	XA1E-BV3U02T-R
40mm Mushroom 	1NC	XA1E-BV4U01KT-R	XA1E-BV4U01T-R
	2NC	XA1E-BV4U02KT-R	XA1E-BV4U02T-R

**Unibody XA Stop Switch**

Style	Operator Type	Contact	① Color Code	Part Number	
				IP40 (black housing)	IP65 (yellow housing)
	29mm Mushroom	1NC	Y: yellow N: gray	XA1E-BV3U01KT-①	XA1E-BV3U01T-①
		2NC		XA1E-BV3U02KT-①	XA1E-BV3U02T-①
	40mm Mushroom	1NC		XA1E-BV4U01KT-①	XA1E-BV4U01T-①
		2NC		XA1E-BV4U02KT-①	XA1E-BV4U02T-①

**EMO XA E-Stop**

Style	NC Main Contact	NO Monitor Contact	Part Number
40mm Mushroom 	1NC	-	XA1E-BV401-RH-EMO
	2NC	-	XA1E-BV402-RH-EMO
	3NC	-	XA1E-BV403-RH-EMO
	4NC	-	XA1E-BV404-RH-EMO
	1NC	1NO	XA1E-BV411-RH-EMO
	2NC	1NO	XA1E-BV412-RH-EMO
	3NC	1NO	XA1E-BV413-RH-EMO

Switches & Pilot Devices

Signaling Lights

Relays & Sockets

Timers

Contactors

Terminal Blocks

Circuit Breakers

**Contact Ratings**

Standard						
Rated Insulation Voltage (Ui)		300V (illuminated part: 60V)				
Rated Current (Ith)		5A				
Rated Operating Voltage (Ue)		30V	125V	250V		
Rated Operating Current	Main Contacts (NC)	AC 50/60Hz	Resistive Load (AC-12)	–	3A	3A
			Inductive Load (AC-15)	–	1.5A	1.5A
	DC		Resistive Load (DC-12)	2A	0.4A	0.2A
			Inductive Load (DC-13)	1A	0.22A	0.1A
Rated Operating Current	Monitor Contacts (NO)	AC 50/60Hz	Resistive Load (AC-12)	–	1.2A	0.6A
			Inductive Load (AC-14)	–	0.6A	0.3A
	DC		Resistive Load (DC-12)	2A	0.4A	0.2A
			Inductive Load (DC-13)	1A	0.22A	0.1A

Unibody						
Rated Insulation Voltage (Ui)		250V				
Thermal Current (Ith)		5A				
Rated Operating Voltage (Ue)		30V	125V	250V		
Rated Operating Current	AC 50/60Hz	Resistive Load (AC-12)	–	5A	3A	
		Inductive Load (AC-15)	–	3A	1.5A	
	DC	Resistive Load (DC-12)	2A	0.4A	0.2A	
		Inductive Load (DC-13)	1A	0.22A	0.1A	

 Minimum applicable load: 5V AC/DC, 1mA (reference value).  
The rated operating currents are measured at resistive/inductive load types specified in IEC 60947-5-1.

**Mounting Hole Layout**

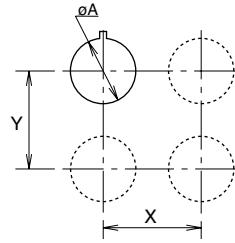

Measurements

Model	øA	X & Y
ø29mm	16.2 <sup>+0.2</sup>	40mm min
ø40mm	16.2 <sup>+0.2</sup>	50mm min

**Panel Cutout**

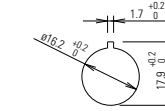

**PC Board Layout - Bottom View**

Non-Illuminated

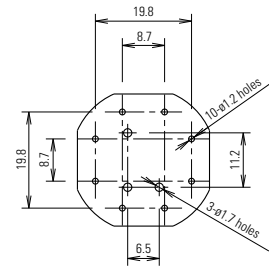

Illuminated

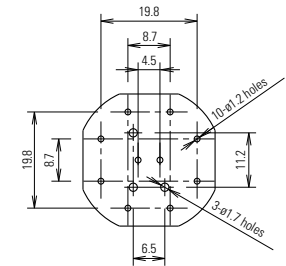

**Illuminated Unit LED Ratings**

Operating Voltage	Current
24V AC/DC ±10%	11mA

**Depth Behind the Panel**

Depth (mm)	Description
27.9 (Standard)	1 - 4 contacts, both illuminated and non-illuminated
23.9 (Unibody)	1NC or 2NC

**Terminal Arrangements (Bottom View)**

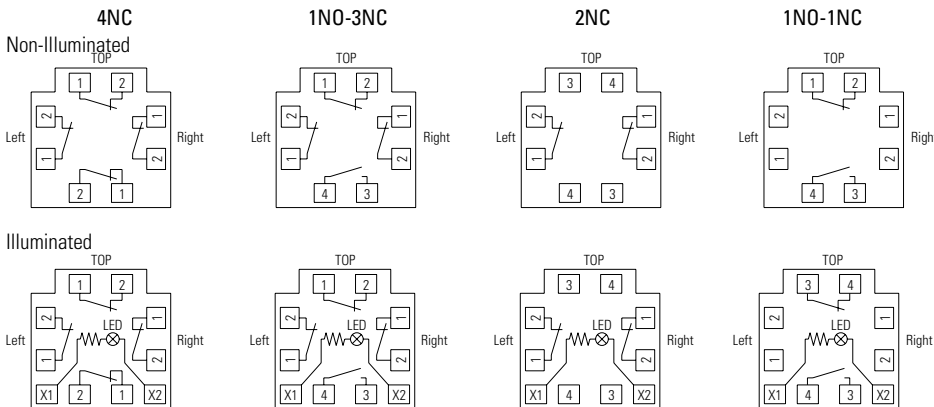

Dimensions (mm)

Non-Illuminated

Illuminated

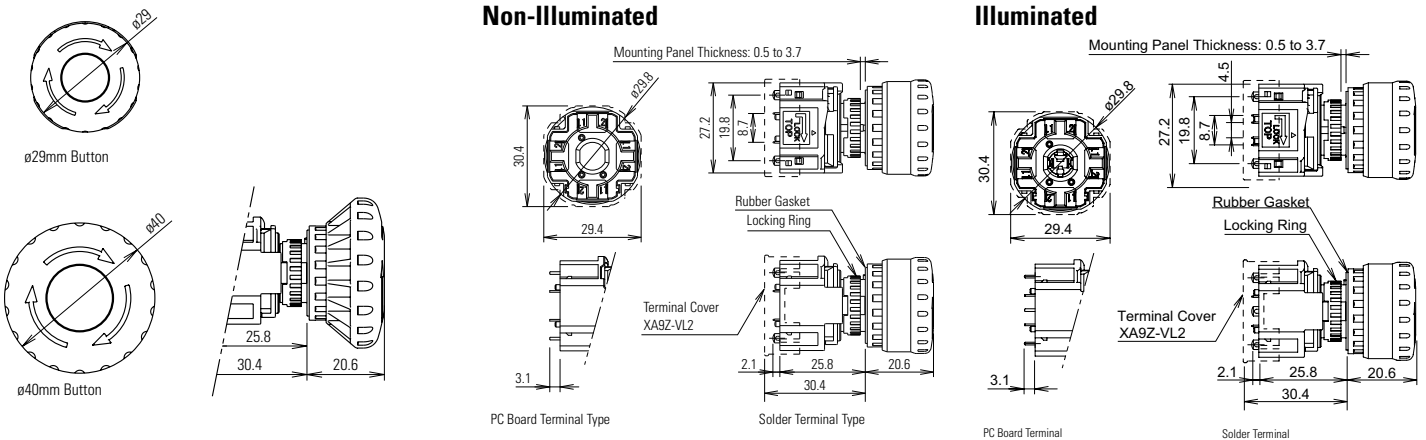

Unibody

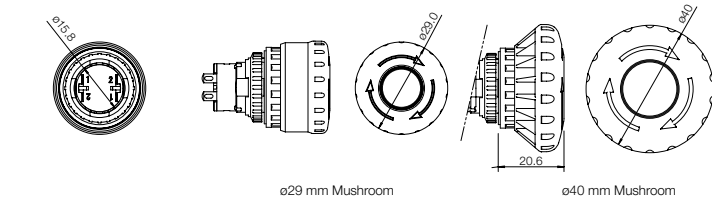
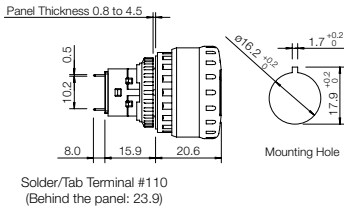

EMO

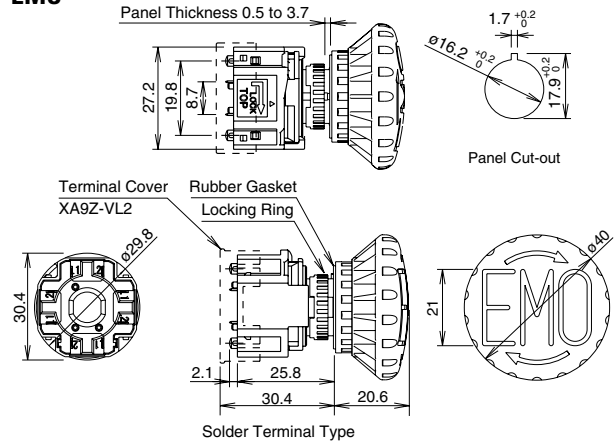

Accessories

Description	Part Numbers
Replacement LED Unit: Solder Terminal	XA9Z-LED2R
Replacement LED Unit: PCB Terminal	XA9Z-LED2VR
Terminal Cover for contact block (solder terminal only)	XA9Z-VL2

Accessories: Shroud

Appearance	Part Number	Applicable Standards
	XA9Z-KG1	SEMI S2 Compliant (Approved by TUV)

Accessories: Nameplates

Appearance	Legend	Part Number	Inner Ø	Outer Ø	Applicable Mushroom Size
	(blank)	HA AV-0	16mm	43mm	29mm
	"Emergency Stop"	HA AV-27	16mm	43mm	
	(blank)	HA AV4-0	16mm	60mm	40mm
	"Emergency Stop"	HA AV4-27	16mm	60mm	

### Operating Instructions

#### Removing the Contact Block

First unlock the operator button. While pushing up the white bayonet ring, using a small screwdriver (width: 2.5 to 3 mm) if necessary, turn the contact block counterclockwise and pull out. **Do not exert excessive force when using a screwdriver, otherwise the bayonet ring may be damaged.**

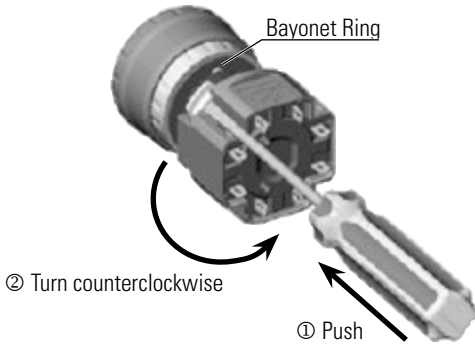

#### Notes for Removing the Contact Block

1. When the contact block is removed, the monitor contact (NO contact) is closed.
2. While removing the contact block, do not exert excessive force, otherwise the switch may be damaged.

#### Panel Mounting

Remove the locking ring from the operator and check that the rubber gasket is in place. Insert the operator from panel front into the panel hole. Face the side with the anti-rotation tab on the operator upward, and tighten the locking ring.

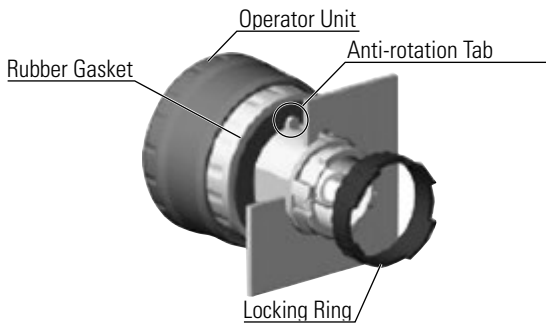

#### Notes for Panel Mounting

To mount XA emergency stop switches onto a panel, tighten the locking ring to a tightening torque of 0.88 N·m maximum using ring wrench MT-001. Do not use pliers. Do not exert excessive force, otherwise the locking ring may be damaged.

#### Installing the Contact Block

First turn the bayonet ring to the unlocked position.

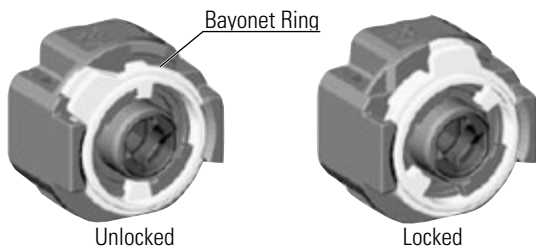

Align the small ▲ marking on the edge of the operator base with the TOP marking on the contact block. Press the contact block onto the operator and turn the contact block clockwise until the bayonet ring clicks.

#### Notes for Installing the Contact Block

Check that the contact block is securely installed on the operator. When the emergency stop switch is properly assembled, the bayonet ring is in place as shown below.

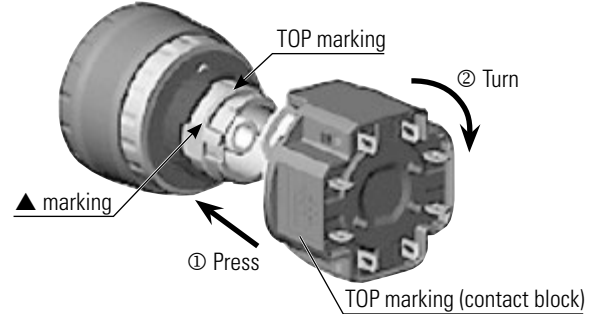

#### Removing the LED Unit

Pull out the LED unit while squeezing the latches on the LED unit using the LED unit removal tool (MT-101).

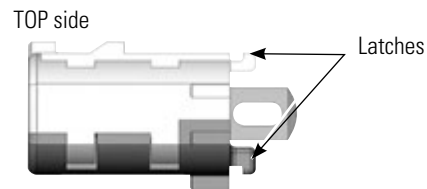
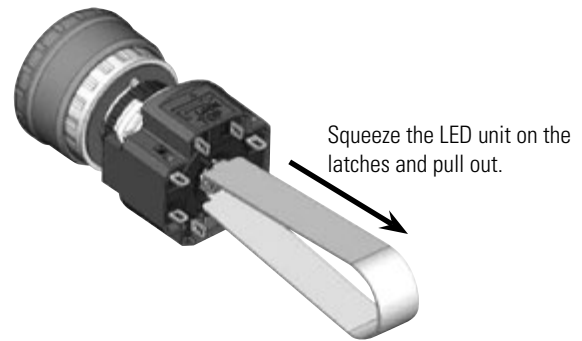

#### Installing the LED Unit

Align the top of the LED unit with the TOP marking on the contact block. Push the LED unit into the contact block.



## Operating Instructions, continued

### Wiring

1. The applicable wire size is 16 AWG maximum.
2. Solder the terminal at a temperature of 310 to 350°C within 3 seconds using a soldering iron. Sn-Ag-Cu solder is recommended. When soldering, do not touch the switch with the soldering iron. Also ensure that no tensile force is applied to the terminals. Do not bend the terminals or apply excessive force to the terminals.
3. Use a non-corrosive rosin flux.
4. Because the terminal spacing is narrow, use protective tubes or heat shrinkable tubes to avoid burning of wire coating or short circuit.

### PC Board Terminal Type

1. When mounting a contact block on a PC board, provide sufficient rotating space for the PC board when installing and removing the contact block.
2. When mounting an XA emergency stop switch on a PC board, make sure that the operator is securely installed.

### About PC Board and Circuit Design

1. Use PC boards made of glass epoxy copper-clad laminated sheets of 1.6 mm in thickness, with double-sided through holes.
2. PC boards and circuits must withstand rated voltage and current, including instantaneous current and voltage at switching.
3. The minimum applicable load is 5V AC/DC, 1 mA.
4. Within the 2.8\* mm areas shown in the figure below, terminals touch the PC board, resulting in possible short circuit on the printed circuit. When designing a PC board pattern, take this possibility into consideration.

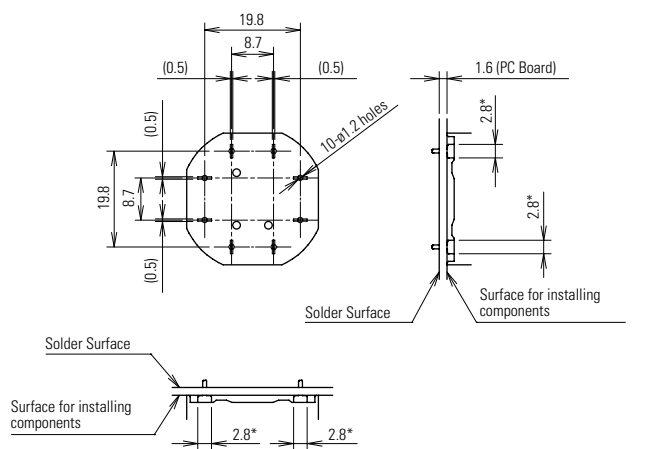

All dimensions in mm.

### Installing Insulation Terminal Cover

To install the terminal cover (XA9Z-VL2), align the TOP marking on the terminal cover with TOP marking on the contact block, and press the terminal cover toward the contact block.

Note: For wiring, insert the wires into the holes in the terminal cover before soldering.

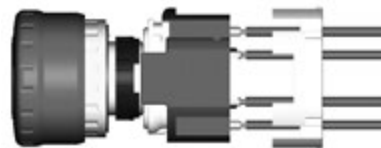

### Contact Bounce

When the button is reset by pulling or turning, the NC main contacts will bounce. When pressing the button, the NO monitor contacts will bounce.

When designing a control circuit, take the contact bounce time into consideration (reference value: 20 ms).

### Nameplate

When anti-rotation is not required, remove the projection from the nameplate using pliers.

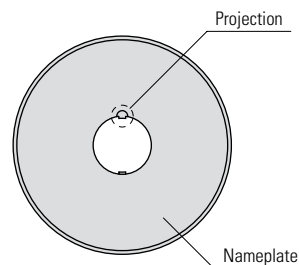

### Handling

Do not expose the switch to excessive shock and vibration, otherwise the switch may be deformed or damaged, causing malfunction or operation failure.

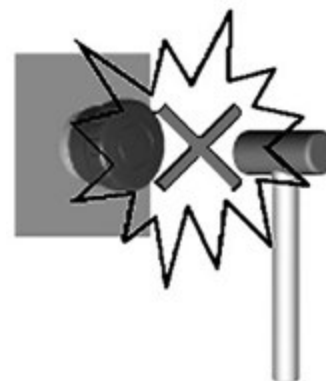

### Safety Precautions

- Turn off power to the XA series emergency stop switch before starting installation, removal, wiring, maintenance, and inspection of the relays. Failure to turn power off may cause electrical shock or fire hazard.
- Use the LED unit removal tool when replacing the LED unit to avoid burning your hands.
- Use wires of the proper size to meet the voltage and current requirements, and solder the wires correctly. If soldering is incomplete, the wire may heat during operation, causing a fire hazard.

## LB Flush Mount & 16mm Miniature Switches & Pilot Lights

Flush bezel projects only 2mm from front of panel. Standard bezel has a depth of only 27.9mm! Removable contact blocks are ideal for single board mounting.

### Key Features

- Pushbuttons, lever switches, selector switches, and key selector switches with up to 3PDT contacts.
- Key selectors with keys that are difficult to duplicate. Seven different key numbers to choose from.
- Pilot lights with flat or dome lenses.
- Buzzers with 80dB steady sound.
- Black or metallic flush bezels available.
- Bright and clear LED illuminated face.
- Choice of either gold-clad or silver contacts.
- Degree of protection: IP65 (from the front of the panel).



Applicable Standards	Mark	File No. or Organization
UL508		UL Recognition No.E55996
CSA 22.2 No.14		CSA File No. LR 21451
EN60947-5-1		TÜV Rheinland
		EU Low Voltage Directive
GB14048.5		

### Specifications

Operating Temperature	-25 to +60°C (no freezing), Illuminated units: -25 to +55°C
Storage Temperature	-30 to +80°C (no freezing)
Operating Humidity	45 to 85% RH (no condensation)
Contact Resistance	50 mW maximum (initial value)
Insulation Resistance	100 MW minimum (500V DC megger)
Dielectric Strength	Switch Between live part and ground: 2,000V AC, 1 min. Between terminals of different poles: 2,000V AC, 1 min. Between terminals of the same poles: 1,000V AC, 1 min.
	Illumination Between live part and ground: 2,000V AC, 1 min.
Vibration Resistance	Operating extremes/Damage limits: 5 to 55 Hz, amplitude 0.5mm
Shock Resistance	Operating extremes: 100 m/s <sup>2</sup> Damage limits: 1,000 m/s <sup>2</sup>
Mechanical Life (minimum operations)	Momentary: 2,000,000 Maintained: 250,000 Selector switches: 250,000 Key selector switches: 250,000
	Momentary: 50,000 / 100,000 <sup>1</sup> Maintained: 50,000 / 100,000 <sup>2</sup> Selector switches: 50,000 / 100,000 <sup>2</sup> Key selector switches: 50,000 / 100,000 <sup>2</sup>
Electrical Life (minimum operations)	
Degree of Protection	IP65 (IEC 60529)
Terminal Style	Solder/tab terminal #110, PC board terminal
Bezel	Black plastic or metallic
Weight (approx.)	11g (lever switch)
	13g (pilot light, pushbutton)
	14g (illuminated pushbutton, pushbutton with guard, buzzer)
	15g (selector switch, illuminated pushbutton with guard)
	27g (key selector switch)

1. Switching frequency 1,800 operations/h.
2. Switching frequency 1,200 operations/h.

### Contact Ratings

Gold Contact (switch base color: blue)			
Rated Insulation Voltage	250V		
Rated Thermal Current	3A		
Rated Operating Voltage	30V DC	125V AC	
Rated Operating Current (resistive load)	0.1A	0.1A	
Contact Material	Gold-clad silver		

Minimum applicable load (reference value): 5V AC/DC, 1 mA

Silver Contact (switch base color: gray)						
Rated Insulation Voltage		250V				
Rated Operating Voltage		30V	125V	250V		
Rated Operating Current	AC 50/60Hz	Resistive load	—	5A	5A	
		Inductive load	—	3A	1.5A	
	DC	Resistive load	5A	1.1A	—	
		Inductive load	2.5A	0.55A	—	
	AC 50/60Hz	Resistive load	—	5A	3A	
		Inductive load	—	3A	1.5A	
DC	Resistive load	3A	0.6A	—		
	Inductive load	1A	0.22A	—		
Rated Thermal Current		5A				
Contact Material		Silver				

AC inductive load: PF=0.6 to 0.7 DC inductive load: L/R=7 ms max.

### LED Ratings

Rated Voltage	5V DC	12V AC/DC	24V AC/DC
Voltage Range	5V DC±5%	12V AC/DC±10%	24V AC/DC ±10%
LED Part No.	LB9Z-LED5 <sup>Ⓢ</sup>	LB9Z-LED1 <sup>Ⓢ</sup>	LB9Z-LED2 <sup>Ⓢ</sup>

Rated Current	A, R: 22 mA G, PW, S: 16 mA
Voltage Rating	Marked on the side of the LED unit

LED Life (reference value) Approx. 30,000 hours (until the brightness reduces to 50% of the initial value)

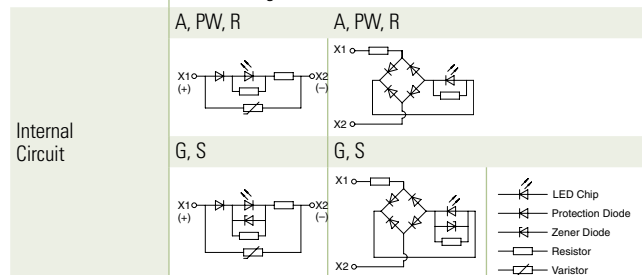

1. For <sup>Ⓢ</sup> (color code): A (amber), G (green), PW (white), R (red), S (blue)
2. Use the white LED for yellow illumination.
3. LED lamp contains a current-limiting resistor.



4.

**Illuminated Pushbuttons (Assembled)**

Style	Operation	Operating Voltage	Contact	Standard Bezel		Flush Bezel		Color Code <sup>Ⓢ</sup>
				Solder/Tab Terminal (silver contacts)	PC Board Terminal (gold contacts)	Solder/Tab Terminal (silver contacts)	PC Board Terminal (gold contacts)	
Standard Bezel (black)   	Momentary	5V DC	SPDT	LBⓈL-M1T51Ⓢ	LBⓈL-M1T11VⓈ	LBⓈⓈL-M1T51Ⓢ	LBⓈⓈL-M1T11VⓈ	Specify the color code in place of Ⓢ:  A: amber G: green R: red S: blue PW: white Y: yellow
			DPDT	LBⓈL-M1T61Ⓢ	LBⓈL-M1T21VⓈ	LBⓈⓈL-M1T61Ⓢ	LBⓈⓈL-M1T21VⓈ	
		12V AC/DC	SPDT	LBⓈL-M1T53Ⓢ	LBⓈL-M1T13VⓈ	LBⓈⓈL-M1T53Ⓢ	LBⓈⓈL-M1T13VⓈ	
			DPDT	LBⓈL-M1T63Ⓢ	LBⓈL-M1T23VⓈ	LBⓈⓈL-M1T63Ⓢ	LBⓈⓈL-M1T23VⓈ	
		24V AC/DC	SPDT	LBⓈL-M1T54Ⓢ	LBⓈL-M1T14VⓈ	LBⓈⓈL-M1T54Ⓢ	LBⓈⓈL-M1T14VⓈ	
			DPDT	LBⓈL-M1T64Ⓢ	LBⓈL-M1T24VⓈ	LBⓈⓈL-M1T64Ⓢ	LBⓈⓈL-M1T24VⓈ	
Flush Bezel (metallic or black)   	Maintained	5V DC	SPDT	LBⓈL-A1T51Ⓢ	LBⓈL-A1T11VⓈ	LBⓈⓈL-A1T51Ⓢ	LBⓈⓈL-A1T11VⓈ	
			DPDT	LBⓈL-A1T61Ⓢ	LBⓈL-A1T21VⓈ	LBⓈⓈL-A1T61Ⓢ	LBⓈⓈL-A1T21VⓈ	
		12V AC/DC	SPDT	LBⓈL-A1T53Ⓢ	LBⓈL-A1T13VⓈ	LBⓈⓈL-A1T53Ⓢ	LBⓈⓈL-A1T13VⓈ	
			DPDT	LBⓈL-A1T63Ⓢ	LBⓈL-A1T23VⓈ	LBⓈⓈL-A1T63Ⓢ	LBⓈⓈL-A1T23VⓈ	
		24V AC/DC	SPDT	LBⓈL-A1T54Ⓢ	LBⓈL-A1T14VⓈ	LBⓈⓈL-A1T54Ⓢ	LBⓈⓈL-A1T14VⓈ	
			DPDT	LBⓈL-A1T64Ⓢ	LBⓈL-A1T24VⓈ	LBⓈⓈL-A1T64Ⓢ	LBⓈⓈL-A1T24VⓈ	
Black Bezel with Guard 		24V AC/DC	SPDT	LBⓈL-A1T54Ⓢ	LBⓈL-A1T14VⓈ	LBⓈⓈL-A1T54Ⓢ	LBⓈⓈL-A1T14VⓈ	
			DPDT	LBⓈL-A1T64Ⓢ	LBⓈL-A1T24VⓈ	LBⓈⓈL-A1T64Ⓢ	LBⓈⓈL-A1T24VⓈ	

- For Standard Bezel part numbers specify:
  - Bezel shape in place of Ⓢ. 1 (round), 2 (square), 3 (rectangular)
  - Lens/LED color in place of Ⓢ. A (amber), G (green), PW (white), R (red), S (blue), Y (yellow)
- For Flush Bezel part numbers specify:
  - Lens/LED in place of Ⓢ. A (amber), G (green), PW (white), R (red), S (blue), Y (yellow)
  - Bezel shape in place of Ⓢ. 6 (round), 7 (square), 8 (rectangular)
  - Bezel material in place of Ⓢ. M (metallic), Blank (black), G (black with guard)
- Solder/Tab terminals have silver contacts and PC Board Terminals have gold contacts.
- Illuminated pushbuttons contain an LED unit.
- See page page 526 for dimensions.
- See page page 541 for replacement LED units.
- Illuminated pushbuttons can be used with legend markings. Engraving can be done on a marking plate which is placed in the lens, or a clear film can be printed and placed in the lens. See page page 543 for details on the marking plate and film.

Switches & Pilot Devices

Signaling Lights

Relays & Sockets

Timers

Contactors

Terminal Blocks

Circuit Breakers



**Illuminated Pushbuttons (Sub-assembled)**

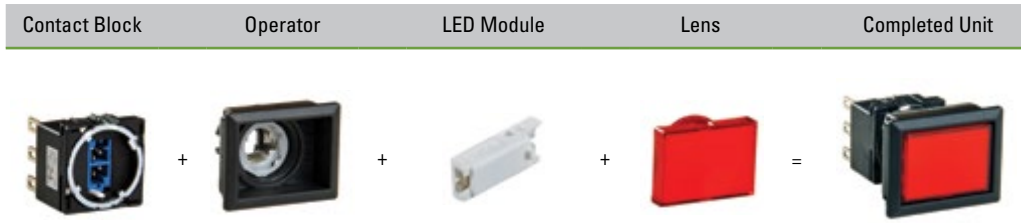

**Contact Block**

Terminal Style	Material	Contact	Part Number
	Silver	SPDT	LB-T50
		DPDT	LB-T60
	Gold	SPDT	LB-T10V
		DPDT	LB-T20V

**LED Module**

Style	Color	Voltage	Part Number
	Amber	5V	LB9Z-LED5A
		12V	LB9Z-LED1A
		24V	LB9Z-LED2A
	Green	5V	LB9Z-LED5G
		12V	LB9Z-LED1G
		24V	LB9Z-LED2G
	Red	5V	LB9Z-LED5R
		12V	LB9Z-LED1R
		24V	LB9Z-LED2R
	Blue	5V	LB9Z-LED5S
		12V	LB9Z-LED1S
		24V	LB9Z-LED2S
	White	5V	LB9Z-LED5PW
		12V	LB9Z-LED1PW
		24V	LB9Z-LED2PW
	Yellow	5V	LB9Z-LED5PW
		12V	LB9Z-LED1PW
		24V	LB9Z-LED2PW

**Operator**

Style	Mounting Style	Shape	Monmontary	Maintained
	Standard (Plastic)	Round	LB1L-M0	LB1L-A0
		Square	LB2L-M0	LB2L-A0
		Rectangular	LB3L-M0	LB3L-A0
	Flush Mount (Plastic)	Round	LB6L-M0	LB6L-A0
		Square	LB7L-M0	LB7L-A0
		Rectangular	LB8L-M0	LB8L-A0
	Flush Mount (Metallic)	Round	LB6ML-M0	LB6ML-A0
		Square	LB7ML-M0	LB7ML-A0
		Rectangular	LB8ML-M0	LB8ML-A0
	Flush Mount (Built-in switch guard)	Round	LB6GL-M0	LB6GL-A0
		Square	LB7GL-M0	LB7GL-A0
		Rectangular	LB8GL-M0	LB8GL-A0

**Lens**

Shape	Color	Part Number
	Amber	LB1A-L1A
	Green	LB1A-L1G
	Red	LB1A-L1R
	Blue	LB1A-L1S
	White	LB1A-L1W
	Yellow	LB1A-L1Y
	Amber	LB2A-L1A
	Green	LB2A-L1G
	Red	LB2A-L1R
	Blue	LB2A-L1S
	White	LB2A-L1W
	Yellow	LB2A-L1Y
	Amber	LB3A-L1A
	Green	LB3A-L1G
	Red	LB3A-L1R
	Blue	LB3A-L1S
	White	LB3A-L1W
	Yellow	LB3A-L1Y

Pilot Lights (Assembled)



Style	Operating Voltage	Standard Bezel		Flush Bezel		② Color Code						
		Solder/Tab Terminal (silver contacts)	PC Board Terminal (gold contacts)	Solder/Tab Terminal (silver contacts)	PC Board Terminal (gold contacts)							
Standard Bezel (black)    	5V DC	LB⓪P-⓪T01⓪	LB⓪P-⓪T01V⓪	LB⓪⓪P-⓪T01⓪	LB⓪⓪P-⓪T01V⓪	Specify the color code in place of ② in the Part Number:  A: amber G: green PW: white R: red S: blue Y: yellow						
							Flush Bezel (metallic or black)    	12V AC/DC	LB⓪P-⓪T03⓪	LB⓪P-⓪T03V⓪	LB⓪⓪P-⓪T03⓪	LB⓪⓪P-⓪T03V⓪

- For Standard Bezel part numbers specify:
  - bezel shape in place of ⓪. 1 (round), 2 (square), 3 (rectangular)
  - lens/LED color in place of ②. A (amber), G (green), PW (white), R (red), S (blue), Y (yellow)
  - lens type code in place of ⓪. 1 (flat), 2 (dome with round lens)
- For Flush Bezel part numbers specify:
  - lens/LED in place of ②. A (amber), G (green), PW (white), R (red), S (blue), Y (yellow)
  - bezel shape in place of ⓪. 6 (round), 7 (square), 8 (rectangular)
  - bezel material in place of ⓪. M (metallic), Blank (black)
  - lens type code in place of ⓪. 1 (flat), 2 (dome with round lens)
- Pilot lights contain an LED unit.
- See page 527 for dimensions.
- See page 541 for replacement LED unit.

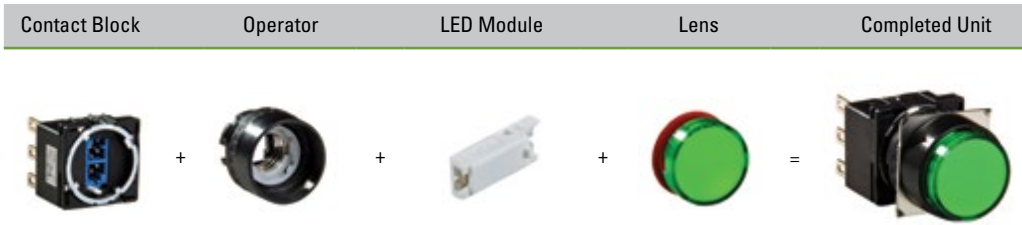
**Pilot Lights (Sub-assembled)**





**Contact Block**

Terminal Style	Part Number
 Solder Tab	LB-T00
 PCB	LB-T00V





**LED Module**

Style	Color	Voltage	Part Number
	Amber	5V	LB9Z-LED5A
		12V	LB9Z-LED1A
		24V	LB9Z-LED2A
Green	Green	5V	LB9Z-LED5G
		12V	LB9Z-LED1G
		24V	LB9Z-LED2G
Red	Red	5V	LB9Z-LED5R
		12V	LB9Z-LED1R
		24V	LB9Z-LED2R
Blue	Blue	5V	LB9Z-LED5S
		12V	LB9Z-LED1S
		24V	LB9Z-LED2S
White	White	5V	LB9Z-LED5PW
		12V	LB9Z-LED1PW
		24V	LB9Z-LED2PW
Yellow	Yellow	5V	LB9Z-LED5PY
		12V	LB9Z-LED1PY
		24V	LB9Z-LED2PY

**Operator**

Style	Mounting Style	Shape	Part Number
	Standard (Plastic)	Round	LB1P-0
		Square	LB2P-0
		Rectangular	LB3P-0
	Flush Mount (Plastic)	Round	LB6P-0
		Square	LB7P-0
		Rectangular	LB8P-0
	Flush Mount (Metallic)	Round	LB6MP-0
		Square	LB7MP-0
		Rectangular	LB8MP-0

**Lens**

Shape	Color	Part Number
	Amber	LB1A-P1A
	Green	LB1A-P1G
	Red	LB1A-P1R
	Blue	LB1A-P1S
	White	LB1A-P1W
	Yellow	LB1A-P1Y
	Amber	LB1A-P2A
	Green	LB1A-P2G
	Red	LB1A-P2R
	Blue	LB1A-P2S
	White	LB1A-P2W
	Yellow	LB1A-P2Y
	Amber	LB2A-P1A
	Green	LB2A-P1G
	Red	LB2A-P1R
	Blue	LB2A-P1S
	White	LB2A-P1W
	Yellow	LB2A-P1Y
	Amber	LB3A-P1A
	Green	LB3A-P1G
	Red	LB3A-P1R
	Blue	LB3A-P1S
	White	LB3A-P1W
	Yellow	LB3A-P1Y

Non-Illuminated Pushbuttons (Assembled)

Style	Operation	Contact	Standard Bezel		Flush Bezel		Ⓢ Color Code
			Solder/Tab Terminal (silver contacts)	PC Board Terminal (gold contacts)	Solder/Tab Terminal (silver contacts)	PC Board Terminal (gold contacts)	
 Standard Bezel (black)	Momentary	SPDT	LBⓈB-M1T5Ⓢ	LBⓈB-M1T1VⓈ	LBⓈⓈB-M1T5Ⓢ	LBⓈⓈB-M1T1VⓈ	Specify the color code in place of Ⓢ in the Part Number:  B: black G: green R: red S: blue W: white Y: yellow
		DPDT	LBⓈB-M1T6Ⓢ	LBⓈB-M1T2VⓈ	LBⓈⓈB-M1T6Ⓢ	LBⓈⓈB-M1T2VⓈ	
		3PDT	LBⓈB-M1T7Ⓢ	LBⓈB-M1T3VⓈ	LBⓈⓈB-M1T7Ⓢ	LBⓈⓈB-M1T3VⓈ	
 Flush Bezel (metallic or black)	Maintained	SPDT	LBⓈB-A1T5Ⓢ	LBⓈB-A1T1VⓈ	LBⓈⓈB-A1T5Ⓢ	LBⓈⓈB-A1T1VⓈ	
		DPDT	LBⓈB-A1T6Ⓢ	LBⓈB-A1T2VⓈ	LBⓈⓈB-A1T6Ⓢ	LBⓈⓈB-A1T2VⓈ	
		3PDT	LBⓈB-A1T7Ⓢ	LBⓈB-A1T3VⓈ	LBⓈⓈB-A1T7Ⓢ	LBⓈⓈB-A1T3VⓈ	
 Black Bezel with Guard		3PDT	LBⓈB-A1T7Ⓢ	LBⓈB-A1T3VⓈ	LBⓈⓈB-A1T7Ⓢ	LBⓈⓈB-A1T3VⓈ	

- For Standard Bezel part numbers specify:
  - bezel shape in place of Ⓢ. 1 (round), 2 (square), 3 (rectangular)
  - lens/LED in place of Ⓢ. B (black), G (green), R (red), S (blue), W (white), Y (yellow)
- For Flush Bezel part numbers specify:
  - lens/LED in place of Ⓢ. B (black), G (green), R (red), S (blue), W (white), Y (yellow)
  - bezel shape in place of Ⓢ. 6 (round), 7 (square), 8 (rectangular)
  - bezel material in place of Ⓢ. M (metallic), Blank (black)
- See page 528 for dimensions.
- Lens can be used with legend markings. Engraving can be done on a marking plate which is placed into the lens, or a clear film can be printed and placed under the lens. For details on the marking plate and film, see page 543.

Switches & Pilot Devices

Signaling Lights

Relays & Sockets

Timers

Contactors

Terminal Blocks

Circuit Breakers

**Non-Illuminated Pushbuttons (Sub-assembled)**

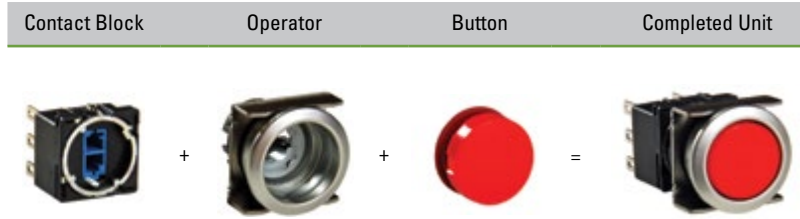

**Contact Block**

Terminal Style	Material	Contact	Part Number
	Solder/Tab	Silver	SPDT LB-T5
			DPDT LB-T6
			3PDT LB-T7
	PCB	Gold	SPDT LB-T1V
			DPDT LB-T2V
			3PDT LB-T3V









**Operator**

Style	Mounting style	Shape	Momentary	Maintained
	Standard (Plastic)	Round	LB1L-M0	LB1L-A0
		Square	LB2L-M0	LB2L-A0
		Rectangular	LB3L-M0	LB3L-A0
	Flush Mount (Plastic)	Round	LB6L-M0	LB6L-A0
		Square	LB7L-M0	LB7L-A0
		Rectangular	LB8L-M0	LB8L-A0
	Flush Mount (Metallic)	Round	LB6ML-M0	LB6ML-A0
		Square	LB7ML-M0	LB7ML-A0
		Rectangular	LB8ML-M0	LB8ML-A0
	Flush Mount (Built-in switch guard)	Round	LB6GL-M0	LB6GL-A0
		Square	LB7GL-M0	LB7GL-A0
		Rectangular	LB8GL-M0	LB8GL-A0

**Button**

Style	Color	Part Number
	Black	LB1A-B1B
	Green	LB1A-B1G
	Red	LB1A-B1R
	Blue	LB1A-B1S
	White	LB1A-B1W
	Yellow	LB1A-B1Y
	Black	LB2A-B1B
	Green	LB2A-B1G
	Red	LB2A-B1R
	Blue	LB2A-B1S
	White	LB2A-B1W
	Yellow	LB2A-B1Y
	Black	LB3A-B1B
	Green	LB3A-B1G
	Red	LB3A-B1R
	Blue	LB3A-B1S
	White	LB3A-B1W
	Yellow	LB3A-B1Y

Selector Switches (Assembled)

Style	Operator Position	Contact	Standard Bezel		Flush Bezel		
			Solder/Tab Terminal (silver contacts)	PC Board Terminal (gold contacts)	Solder/Tab Terminal (silver contacts)	PC Board Terminal (gold contacts)	
Standard Bezel (black) 	90° 2-position	Maintained 	SPDT	LB⓪S-2⓪T5	LB⓪S-2⓪T1V	LB⓪S-2⓪T5	LB⓪S-2⓪T1V
		DPDT	LB⓪S-2⓪T6	LB⓪S-2⓪T2V	LB⓪S-2⓪T6	LB⓪S-2⓪T2V	
		3PDT	LB⓪S-2⓪T7	LB⓪S-2⓪T3V	LB⓪S-2⓪T7	LB⓪S-2⓪T3V	
		Spring return from right 	SPDT	LB⓪S-21⓪T5	LB⓪S-21⓪T1V	LB⓪S-21⓪T5	LB⓪S-21⓪T1V
		DPDT	LB⓪S-21⓪T6	LB⓪S-21⓪T2V	LB⓪S-21⓪T6	LB⓪S-21⓪T2V	
		3PDT	LB⓪S-21⓪T7	LB⓪S-21⓪T3V	LB⓪S-21⓪T7	LB⓪S-21⓪T3V	
	45° 3-position	Maintained 	DPDT	LB⓪S-3⓪T6	LB⓪S-3⓪T2V	LB⓪S-3⓪T6	LB⓪S-3⓪T2V
		3PDT	LB⓪S-3⓪T7	LB⓪S-3⓪T3V	LB⓪S-3⓪T7	LB⓪S-3⓪T3V	
		Spring return from right 	DPDT	LB⓪S-31⓪T6	LB⓪S-31⓪T2V	LB⓪S-31⓪T6	LB⓪S-31⓪T2V
3PDT		LB⓪S-31⓪T7	LB⓪S-31⓪T3V	LB⓪S-31⓪T7	LB⓪S-31⓪T3V		
Spring return from left 		DPDT	LB⓪S-32⓪T6	LB⓪S-32⓪T2V	LB⓪S-32⓪T6	LB⓪S-32⓪T2V	
3PDT		LB⓪S-32⓪T7	LB⓪S-32⓪T3V	LB⓪S-32⓪T7	LB⓪S-32⓪T3V		
Flush Bezel (metallic or black) 	Spring return two-way 	DPDT	LB⓪S-33⓪T6	LB⓪S-33⓪T2V	LB⓪S-33⓪T6	LB⓪S-33⓪T2V	
		3PDT	LB⓪S-33⓪T7	LB⓪S-33⓪T3V	LB⓪S-33⓪T7	LB⓪S-33⓪T3V	

Knob models shown above unless otherwise indicated.

- For Standard Bezel part numbers specify:
  - bezel shape in place of ⓪. 1 (round), 2 (square), 3 (rectangular)
  - operator shape in place of ⓪. blank (knob), L (lever).
- For Flush Bezel part numbers specify:
  - bezel shape in place of ⓪. 6 (round), 7 (square), 8 (rectangular)
  - bezel material in place of ⓪. M (metallic), Blank (black)
  - operator shape in place of ⓪. blank (knob), L (lever).
- See page page 524 for contact operation .
- See page page 530 for dimensions.

**Selector Switches (Sub-assembled)**

Contact Block      Operator      Completed Unit



**Contact Block**

Terminal Style	Material	Contact	Part Number
	Solder/Tab	Silver	SPDT LB-T5
			DPDT LB-T6
			3PDT LB-T7
	PCB	Gold	SPDT LB-T1V
			DPDT LB-T2V
			3PDT LB-T3V

SPDT contacts applicable for 2-position switches only.

**Operator**

Style	Shape	Position	Function	Part Number		
				Knob	Lever	
Standard (Plastic) 	Round	2	Maintained	LB1S-2Y	LB1S-2L	
			Spring from right	LB1S-21Y	LB1S-21L	
		3	Maintained	LB1S-3Y	LB1S-3L	
			Spring from right	LB1S-31Y	LB1S-31L	
			Spring from left	LB1S-32Y	LB1S-32L	
			Spring from both	LB1S-33Y	LB1S-33L	
Rectangular 	Square	2	Maintained	LB2S-2Y	LB2S-2L	
			Spring from right	LB2S-21Y	LB2S-21L	
		3	Maintained	LB2S-3Y	LB2S-3L	
			Spring from right	LB2S-31Y	LB2S-31L	
	Spring from left		LB2S-32Y	LB2S-32L		
	Spring from both		LB2S-33Y	LB2S-33L		
	Rectangular	2	Maintained	LB3S-2Y	LB3S-2L	
			Spring from right	LB3S-21Y	LB3S-21L	
			3	Maintained	LB3S-3Y	LB3S-3L
				Spring from right	LB3S-31Y	LB3S-31L
		Spring from left		LB3S-32Y	LB3S-32L	
		Spring from both		LB3S-33Y	LB3S-33L	

Style	Shape	Position	Function	Part Number		
				Knob	Lever	
Flush Mount (Plastic) 	Round	2	Maintained	LB6S-2Y	LB6S-2L	
			Spring from right	LB6S-21Y	LB6S-21L	
		3	Maintained	LB6S-3Y	LB6S-3L	
			Spring from right	LB6S-31Y	LB6S-31L	
			Spring from left	LB6S-32Y	LB6S-32L	
Round 	Square	2	Maintained	LB7S-2Y	LB7S-2L	
			Spring from right	LB7S-21Y	LB7S-21L	
		3	Maintained	LB7S-3Y	LB7S-3L	
			Spring from right	LB7S-31Y	LB7S-31L	
			Spring from left	LB7S-32Y	LB7S-32L	
Square 	Rectangular	2	Maintained	LB8S-2Y	LB8S-2L	
			Spring from right	LB8S-21Y	LB8S-21L	
		3	Maintained	LB8S-3Y	LB8S-3L	
			Spring from right	LB8S-31Y	LB8S-31L	
			Spring from left	LB8S-32Y	LB8S-32L	
Flush Mount (Metallic) 	Round	2	Maintained	LB6MS-2Y	LB6MS-2L	
			Spring from right	LB6MS-21Y	LB6MS-21L	
		3	Maintained	LB6MS-3Y	LB6MS-3L	
			Spring from right	LB6MS-31Y	LB6MS-31L	
	Spring from left		LB6MS-32Y	LB6MS-32L		
	Spring from both		LB6MS-33Y	LB6MS-33L		
	Round 	Square	2	Maintained	LB7MS-2Y	LB7MS-2L
				Spring from right	LB7MS-21Y	LB7MS-21L
			3	Maintained	LB7MS-3Y	LB7MS-3L
				Spring from right	LB7MS-31Y	LB7MS-31L
	Square 	Rectangular	2	Maintained	LB8MS-2Y	LB8MS-2L
				Spring from right	LB8MS-21Y	LB8MS-21L
3			Maintained	LB8MS-3Y	LB8MS-3L	
			Spring from right	LB8MS-31Y	LB8MS-31L	
			Spring from left	LB8MS-32Y	LB8MS-32L	
			Spring from both	LB8MS-33Y	LB8MS-33L	



**Illuminated Selector Switches (Assembled)**

Style	Operating Voltage	Operator Position	Contact	Standard Bezel		Flush Bezel		
				Solder/Tab Terminal (silver contacts)	PC Board Terminal (gold contacts)	Solder/Tab Terminal (silver contacts)	PC Board Terminal (gold contacts)	
Standard Bezel (black) 	5V DC	90° 2-position	Maintained L R	SPDT	LB⓪F-2T51⓪	LB⓪F-2T11V⓪	LB6⓪F-2T51⓪	LB6⓪F-2T11V⓪
			DPDT	LB⓪F-2T61⓪	LB⓪F-2T21V⓪	LB6⓪F-2T61⓪	LB6⓪F-2T21V⓪	
		45° 3-position	Maintained L C R	DPDT	LB⓪F-3T61⓪	LB⓪F-3T21V⓪	LB6⓪F-3T61⓪	LB6⓪F-3T21V⓪
			12V AC/DC	90° 2-position	Maintained L R	SPDT	LB⓪F-2T53⓪	LB⓪F-2T13V⓪
	DPDT	LB⓪F-2T63⓪			LB⓪F-2T23V⓪	LB6⓪F-2T63⓪	LB6⓪F-2T23V⓪	
	Flush Bezel (metallic or black) 	45° 3-position	Maintained L C R	DPDT	LB⓪F-3T63⓪	LB⓪F-3T23V⓪	LB6⓪F-3T63⓪	LB6⓪F-3T23V⓪
24V AC/DC					90° 2-position	Maintained L R	SPDT	LB⓪F-2T54⓪
		DPDT	LB⓪F-2T64⓪	LB⓪F-2T24V⓪		LB6⓪F-2T64⓪	LB6⓪F-2T24V⓪	
		45° 3-position	Maintained L C R	DPDT	LB⓪F-3T64⓪	LB⓪F-3T24V⓪	LB6⓪F-3T64⓪	LB6⓪F-3T24V⓪

Flush bezel only available with round operator.

9. For Standard Bezel part numbers specify:
  - bezel shape in place of ⓪. 1 (round), 2 (square), 3 (rectangular)
  - color code in place of ⓪. A (amber), G (green), R (red), S (blue), PW (white), Y (yellow)
10. For Flush Bezel part numbers specify:
  - color code in place of ⓪. A (amber), G (green), R (red), S (blue), PW (white), Y (yellow)
  - bezel material in place of ⓪. M (metallic), Blank (black)
11. See page page 524 for contact operation.
12. See page page 532 for dimensions.

Switches & Pilot Devices

Signaling Lights

Relays & Sockets

Timers

Contactors

Terminal Blocks

Circuit Breakers

**Illuminated Selector Switches (Sub-assembled)**

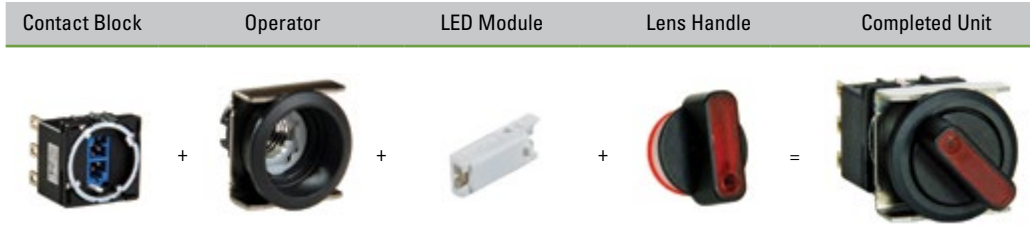

**Contact Block**

Terminal Style	Material	Contact	Part Number
	Silver	SPDT	LB-T50
		DPDT	LB-T60
	Gold	SPDT	LB-T10
		DPDT	LB-T20
	Gold	SPDT	LB-T10V
		DPDT	LB-T20V

SPDT contacts applicable for 2-position switches only.

**Operator**

Style	Shape	Position	Function	Part Number
	Round	2	Maintained	LB1F-2
		3	Maintained	LB1F-3
	Square	2	Maintained	LB2F-2
		3	Maintained	LB2F-3
	Rectangular	2	Maintained	LB3F-2
		3	Maintained	LB3F-3
	Round	2	Maintained	LB6F-2
		3	Maintained	LB6F-3
	Round	2	Maintained	LB6MF-2
		3	Maintained	LB6MF-3

**LED Module**

Style	Color	Voltage	Part Number
	Amber	5V	LB9Z-LED5A
		12V	LB9Z-LED1A
		24V	LB9Z-LED2A
Green	5V	LB9Z-LED5G	
	12V	LB9Z-LED1G	
	24V	LB9Z-LED2G	
Red	5V	LB9Z-LED5R	
	12V	LB9Z-LED1R	
	24V	LB9Z-LED2R	
Blue	5V	LB9Z-LED5S	
	12V	LB9Z-LED1S	
	24V	LB9Z-LED2S	
White	5V	LB9Z-LED5PW	
	12V	LB9Z-LED1PW	
	24V	LB9Z-LED2PW	
Yellow	5V	LB9Z-LED5PW	
	12V	LB9Z-LED1PW	
	24V	LB9Z-LED2PW	

**Lens Handle**

Style	Color	Part Number
	Amber	LA1A-FA
	Green	LA1A-FG
	Red	LA1A-FR
	Blue	LA1A-FS
	White	LA1A-FW
	Yellow	LA1A-FY

Key Selector Switches (Assembled)

Style	Operator Position	Key retained at ●	Contact	Standard Bezel		Flush Bezel		
				Solder/Tab Terminal (silver contacts)	PC Board Terminal (gold contacts)	Solder/Tab Terminal (silver contacts)	PC Board Terminal (gold contacts)	
Standard Bezel (black) 	90° 2-position	Maintained		SPDT	LB⊙K-2T5A	LB⊙K-2T1VA	LB⊙⊕K-2T5A	LB⊙⊕K-2T1VA
				DPDT	LB⊙K-2T6A	LB⊙K-2T2VA	LB⊙⊕K-2T6A	LB⊙⊕K-2T2VA
				3PDT	LB⊙K-2T7A	LB⊙K-2T3VA	LB⊙⊕K-2T7A	LB⊙⊕K-2T3VA
				SPDT	LB⊙K-2T5B	LB⊙K-2T1VB	LB⊙⊕K-2T5B	LB⊙⊕K-2T1VB
				DPDT	LB⊙K-2T6B	LB⊙K-2T2VB	LB⊙⊕K-2T6B	LB⊙⊕K-2T2VB
				3PDT	LB⊙K-2T7B	LB⊙K-2T3VB	LB⊙⊕K-2T7B	LB⊙⊕K-2T3VB
	Spring return from right		SPDT	LB⊙K-2T5C	LB⊙K-2T1VC	LB⊙⊕K-2T5C	LB⊙⊕K-2T1VC	
			DPDT	LB⊙K-2T6C	LB⊙K-2T2VC	LB⊙⊕K-2T6C	LB⊙⊕K-2T2VC	
			3PDT	LB⊙K-2T7C	LB⊙K-2T3VC	LB⊙⊕K-2T7C	LB⊙⊕K-2T3VC	
				SPDT	LB⊙K-21T5B	LB⊙K-21T1VB	LB⊙⊕K-21T5B	LB⊙⊕K-21T1VB
				DPDT	LB⊙K-21T6B	LB⊙K-21T2VB	LB⊙⊕K-21T6B	LB⊙⊕K-21T2VB
				3PDT	LB⊙K-21T7B	LB⊙K-21T3VB	LB⊙⊕K-21T7B	LB⊙⊕K-21T3VB
Flush Bezel (metallic or black) 	45° 3-position	Maintained		DPDT	LB⊙K-3T6A	LB⊙K-3T2VA	LB⊙⊕K-3T6A	LB⊙⊕K-3T2VA
				3PDT	LB⊙K-3T7A	LB⊙K-3T3VA	LB⊙⊕K-3T7A	LB⊙⊕K-3T3VA
				DPDT	LB⊙K-3T6B	LB⊙K-3T2VB	LB⊙⊕K-3T6B	LB⊙⊕K-3T2VB
				3PDT	LB⊙K-3T7B	LB⊙K-3T3VB	LB⊙⊕K-3T7B	LB⊙⊕K-3T3VB
				DPDT	LB⊙K-3T6C	LB⊙K-3T2VC	LB⊙⊕K-3T6C	LB⊙⊕K-3T2VC
				3PDT	LB⊙K-3T7C	LB⊙K-3T3VC	LB⊙⊕K-3T7C	LB⊙⊕K-3T3VC
				DPDT	LB⊙K-3T6D	LB⊙K-3T2VD	LB⊙⊕K-3T6D	LB⊙⊕K-3T2VD
				3PDT	LB⊙K-3T7D	LB⊙K-3T3VD	LB⊙⊕K-3T7D	LB⊙⊕K-3T3VD
				DPDT	LB⊙K-3T6E	LB⊙K-3T2VE	LB⊙⊕K-3T6E	LB⊙⊕K-3T2VE
				3PDT	LB⊙K-3T7E	LB⊙K-3T3VE	LB⊙⊕K-3T7E	LB⊙⊕K-3T3VE
				DPDT	LB⊙K-3T6G	LB⊙K-3T2VG	LB⊙⊕K-3T6G	LB⊙⊕K-3T2VG
				3PDT	LB⊙K-3T7G	LB⊙K-3T3VG	LB⊙⊕K-3T7G	LB⊙⊕K-3T3VG
				DPDT	LB⊙K-3T6H	LB⊙K-3T2VH	LB⊙⊕K-3T6H	LB⊙⊕K-3T2VH
				3PDT	LB⊙K-3T7H	LB⊙K-3T3VH	LB⊙⊕K-3T7H	LB⊙⊕K-3T3VH

Assembled Key Selector Switches con't on next page.

**Assembled Key Selector Switches con't on next page.**

Style	Operator Position	Key retained at ●	Contact	Standard Bezel		Flush Bezel			
				Solder/Tab Terminal (silver contacts)	PC Board Terminal (gold contacts)	Solder/Tab Terminal (silver contacts)	PC Board Terminal (gold contacts)		
Standard Bezel (black)    Flush Bezel (metallic or black)  	45° 3-position	Spring return from right	B		DPDT	LB⓪K-31T6B	LB⓪K-31T2VB	LB⓪⓪K-31T6B	LB⓪⓪K-31T2VB
				3PDT	LB⓪K-31T7B	LB⓪K-31T3VB	LB⓪⓪K-31T7B	LB⓪⓪K-31T3VB	
			D		DPDT	LB⓪K-31T6D	LB⓪K-31T2VD	LB⓪⓪K-31T6D	LB⓪⓪K-31T2VD
				3PDT	LB⓪K-31T7D	LB⓪K-31T3VD	LB⓪⓪K-31T7D	LB⓪⓪K-31T3VD	
			G		DPDT	LB⓪K-31T6G	LB⓪K-31T2VG	LB⓪⓪K-31T6G	LB⓪⓪K-31T2VG
				3PDT	LB⓪K-31T7G	LB⓪K-31T3VG	LB⓪⓪K-31T7G	LB⓪⓪K-31T3VG	
		Spring return from left	C		DPDT	LB⓪K-32T6C	LB⓪K-32T2VC	LB⓪⓪K-32T6C	LB⓪⓪K-32T2VC
				3PDT	LB⓪K-32T7C	LB⓪K-32T3VC	LB⓪⓪K-32T7C	LB⓪⓪K-32T3VC	
			D		DPDT	LB⓪K-32T6D	LB⓪K-32T2VD	LB⓪⓪K-32T6D	LB⓪⓪K-32T2VD
				3PDT	LB⓪K-32T7D	LB⓪K-32T3VD	LB⓪⓪K-32T7D	LB⓪⓪K-32T3VD	
			H		DPDT	LB⓪K-32T6H	LB⓪K-32T2VH	LB⓪⓪K-32T6H	LB⓪⓪K-32T2VH
				3PDT	LB⓪K-32T7H	LB⓪K-32T3VH	LB⓪⓪K-32T7H	LB⓪⓪K-32T3VH	
Spring return two-way	D		DPDT	LB⓪K-33T6D	LB⓪K-33T2VD	LB⓪⓪K-33T6D	LB⓪⓪K-33T2VD		
		3PDT	LB⓪K-33T7D	LB⓪K-33T3VD	LB⓪⓪K-33T7D	LB⓪⓪K-33T3VD			

- 13. Key is retained at ● and removable at ○ positions.
- 14. Two keys are supplied.
- 15. For Standard Bezel part numbers specify bezel shape in place of ⓪. 1 (round), 2 (square), 3 (rectangular)
- 16. For Flush Bezel part numbers specify:
  - bezel shape in place of ⓪. 6 (round), 7 (square), 8 (rectangular)
  - bezel material in place of ⓪. M (metallic), Blank (black)
- 17. See page page 524 for contact operation.
- 18. See page page 533 for dimensions.
- 19. For additional security, wave keys also available.
  - Add the letter "S" before the "T" in the part no. Example: LB1K-31ST1A
  - Besides the standard wave key (key number 0H), six other keys are available.
  - To order other keys, specify the key number as shown below:
  - Example: LB1K-31ST2B-1H (Key number is indicated on the key cylinder. Standard keys do not have a key number indication.)
  - \_\_\_\_\_ (blank): Standard wave key (0H)
    - 1H to 2H: Reversible wave key
    - 3H to 6H: Non-reversible wave key
- 20. If ordering standard wave key (0H), subcomponents are available, see next page.
- 21. If ordering other than standard wave key (for example, key number 6H), only completed switches are available.

Key Selector Switches (Sub-assembled)

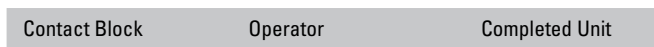

Contact Block

Terminal Style		Material	Contact	Part Number
	Solder/Tab	Silver	SPDT	LB-T5
			DPDT	LB-T6
			3PDT	LB-T7
	PCB	Gold	SPDT	LB-T1V
			DPDT	LB-T2V
			3PDT	LB-T3V

Operator

Style	Shape	Position	Function	Part number
	Round	2	Maintained	LB1K-2Ⓢ
			Spring from right	LB1K-21B
		3	Maintained	LB1K-3Ⓢ
			Spring from right	LB1K-31Ⓢ
			Spring from left	LB1K-32Ⓢ
			Spring from both	LB1K-33D
	Square	2	Maintained	LB2K-2Ⓢ
			Spring from right	LB2K-21B
		3	Maintained	LB2K-3Ⓢ
			Spring from right	LB2K-31Ⓢ
			Spring from left	LB2K-32Ⓢ
			Spring from both	LB2K-33D
	Rectangular	2	Maintained	LB3K-2Ⓢ
			Spring from right	LB3K-21B
		3	Maintained	LB3K-3Ⓢ
			Spring from right	LB3K-31Ⓢ
			Spring from left	LB3K-32Ⓢ
			Spring from both	LB3K-33D

Style	Shape	Position	Function	Part number	
	Round	2	Maintained	LB6K-2Ⓢ	
			Spring from right	LB6K-21B	
		3	Maintained	LB6K-3Ⓢ	
			Spring from right	LB6K-31Ⓢ	
			Spring from left	LB6K-32Ⓢ	
			Spring from both	LB6K-33D	
	Square	2	Maintained	LB7K-2Ⓢ	
			Spring from right	LB7K-21B	
		3	Maintained	LB7K-3Ⓢ	
			Spring from right	LB7K-31Ⓢ	
			Spring from left	LB7K-32Ⓢ	
			Spring from both	LB7K-33D	
		Rectangular	2	Maintained	LB8K-2Ⓢ
				Spring from right	LB8K-21B
			3	Maintained	LB8K-3Ⓢ
				Spring from right	LB8K-31Ⓢ
				Spring from left	LB8K-32Ⓢ
				Spring from both	LB8K-33D
Round		2	Maintained	LB6MK-2Ⓢ	
			Spring from right	LB6MK-21B	
		3	Maintained	LB6MK-3Ⓢ	
			Spring from right	LB6MK-31Ⓢ	
			Spring from left	LB6MK-32Ⓢ	
			Spring from both	LB6MK-33D	
Square		2	Maintained	LB7MK-2Ⓢ	
			Spring from right	LB7MK-21B	
		3	Maintained	LB7MK-3Ⓢ	
			Spring from right	LB7MK-31Ⓢ	
			Spring from left	LB7MK-32Ⓢ	
			Spring from both	LB7MK-33D	
Rectangular	2	Maintained	LB8MK-2Ⓢ		
		Spring from right	LB8MK-21B		
	3	Maintained	LB8MK-3Ⓢ		
		Spring from right	LB8MK-31Ⓢ		
		Spring from left	LB8MK-32Ⓢ		
		Spring from both	LB8MK-33D		

22. In place of Ⓢ specify retention option code from table below.  
 23. For standard wave key operators, add "S" to part number before the key retention code from table below. (For example, LB6K-2B with wave key would be LB6K-2SB.)

Ⓢ Retention Option Code

Code	Description	Code	Description
A	Key not retained in any position (removable in all positions)	E	Key retained in center only (3-position only)
B	Key retained in right position only	G	Key retained in right and center (3-position only)
C	Key retained in left position only	H	Key retained in left and center (3-position only)
D	Key retained in left and right (3-position only)		

Switches & Pilot Devices

Signaling Lights

Relays & Sockets





Timers

Contactors

Terminal Blocks

Circuit Breakers

### Lever Switches (Assembled)



Style	Operator Position	Contact	Solder/Tab Terminal (silver contacts)	PC Board Terminal (gold contacts)
Standard Bezel (black) 	2-position	Maintained 	SPDT LB⊙T-2T5	LB⊙T-2T1V
			DPDT LB⊙T-2T6	LB⊙T-2T2V
			3PDT LB⊙T-2T7	LB⊙T-2T3V
Flush Bezel (black) 	3-position	Maintained 	DPDT LB⊙T-3T2	LB⊙T-3T6V
			3PDT LB⊙T-3T3	LB⊙T-3T7V
		Spring return from top/bottom 	DPDT LB⊙T-33T2	LB⊙T-33T6V
		3PDT LB⊙T-33T3	LB⊙T-33T7V	

24. For all part numbers, specify bezel in place of ⊙. 1 (standard bezel), 6 (flush bezel).  
 25. See page page 524 for contact operation.  
 26. See page page 535 for dimensions.



### Lever Switches (Sub-assembled)



#### Contact Block

Terminal Style	Material	Contact	Part Number
 Solder/Tab	Silver	SPDT	LB-T5
		DPDT	LB-T6
		3PDT	LB-T7
	Gold	SPDT	LB-T1
		DPDT	LB-T2
		3PDT	LB-T3
 PCB	Gold	SPDT	LB-T1V
		DPDT	LB-T2V
		3PDT	LB-T3V

#### Operator

Style	Position	Function	Part Number
Round Standard (Plastic) 	2	Maintained	LB1T-2
		Maintained	LB1T-3
	3	Spring return from both	LB1T-33
Round Flush Mount (Plastic) 	2	Maintained	LB6T-2
		Maintained	LB6T-3
	3	Spring return from both	LB6T-33

**Buzzers (Assembled)**

Style	Shape	Voltage	Standard Bezel		Flush Bezel	
			Solder/Tab Terminal	PC Board Terminal	Solder/Tab Terminal	PC Board Terminal
Black Bezel   	Round	12V DC	–	–	LB6Z-1T03	LB6Z-1T03V
		24V DC	–	–	LB6Z-1T04	LB6Z-1T04V
	Rectangular	12V DC	LB3Z-1T03	LB3Z-1T03V	LB8Z-1T03	LB8Z-1T03V
		24V DC	LB3Z-1T04	LB3Z-1T04V	LB8Z-1T04	LB8Z-1T04V
Metallic Bezel  	Round	12V DC	–	–	LB6MZ-1T03	LB6MZ-1T03V
		24V DC	–	–	LB6MZ-1T04	LB6MZ-1T04V
	Rectangular	12V DC	–	–	LB8MZ-1T03	LB8MZ-1T03V
		24V DC	–	–	LB8MZ-1T04	LB8MZ-1T04V

27. IP54 Rated.  
 28. For IP40 rating, use part number LB3Z-104K.  
 29. See page 536 for dimensions.

**Buzzers (Sub-assembled)**



**Contact Block**

Terminal Style		Part Number
	Solder/Tab	LB-T00
	PCB	LB-T00V

**Operator**

Style	Mounting Style	Shape	Voltage	
			12V DC	24V DC
	Standard (Plastic)	Rectangular	LB3Z-103	LB3Z-104
	Flush Mount (Plastic)	Round	LB6Z-103	LB6Z-104
		Rectangular	LB8Z-103	LB8Z-104
	Flush Mount (Metallic)	Round	LB6MZ-103	LB6MZ-104
		Rectangular	LB8MZ-103	LB8MZ-104



**Contact Operation**

**Selector Switch, Illuminated Selector Switch, Key Selector Switch**

Operator Position & Contact Operation (Top View)					
Position		Contact	↙ Left	↑ Center	↘ Right
90° 2-position	<p>Maintained</p>	SPDT			
		DPDT			
		3PDT			
45° 3-position	<p>Maintained</p>	DPDT			
		3PDT			
	<p>Spring return from right</p>				
	<p>Spring return from left</p>				
	<p>Spring return two-way</p>				

**Lever Switch**

Lever Position & Contact Operation (Top View)					
Position		Contact	Down	Center	Up
90° 2-position	<p>Maintained</p>	SPDT			
		DPDT			
		3PDT			
45° 3-position	<p>Maintained</p>	DPDT			
		3PDT			
	<p>Spring return two-way</p>				

**Mounting Hole Layout (mm)**

Standard Bezels

LB1/LB2/LB3

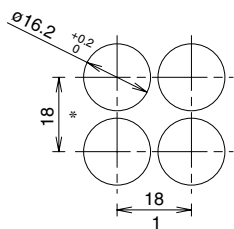

\*1. Rectangular: 24mm  
3PDT: 23.2mm  
\*2. 3PDT: 21mm

Flush Bezels

Round

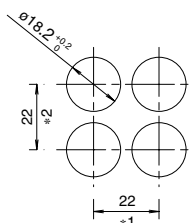

Square

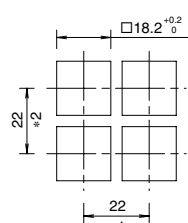

Rectangular

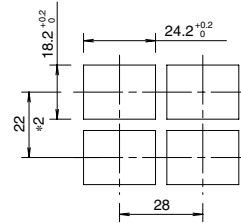

\*1. 3PDT: 23.2mm  
\*2. Switches with Guard: 45mm

When using the LB series with a rubber boot or terminal cover, make sure to note the dimensions on pages page 539 and page 540.

### PC Board Drilling Layout (mm)

#### Notes for Designing PC Board and Circuit

1. Use 1.6mm-thick glass epoxy PC board with drilled holes.
2. Design a circuit so that the LB series can operate within the rated voltage and current range. Make sure that inrush current and voltage do not exceed the rating.
3. Minimum applicable load is 5V AC/DC, 1mA on gold contacts.
4. Since the \*2.8mm-wide terminal touches the PC board as shown below, short circuit may occur with pattern lines. Design a circuit that prevents short circuits.

#### SPDT/DPDT Contacts

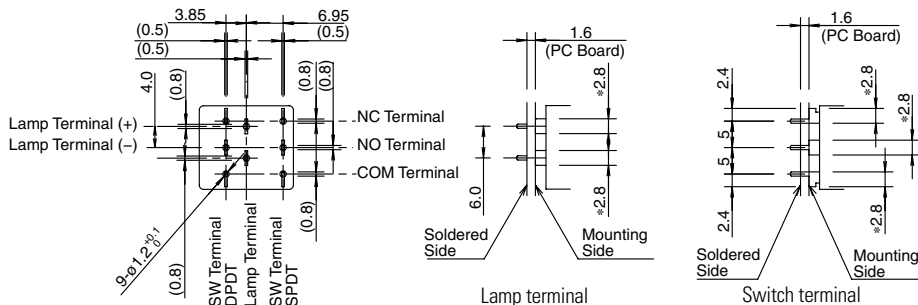

#### 3PDT Contacts

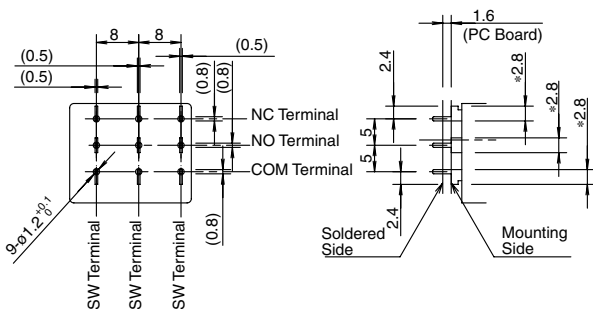

#### PC Board Drilling Layout (Bottom View)

##### SPDT/DPDT Contacts

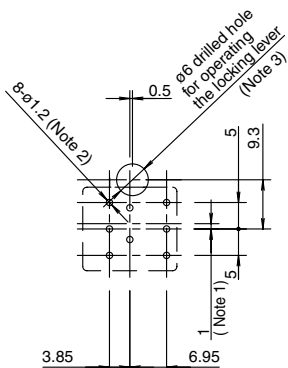

##### 3PDT Contacts

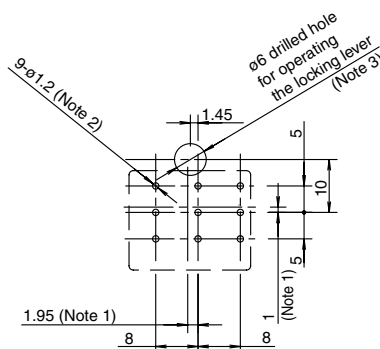

5. When designing, note the alignment of the center lines of the contact blocks and operators.
6. The diameter of the terminal hole is ø1.2.
7. Hole diameter may vary to meet installation requirements. Determine the location and the size of the hole so that the locking lever can be operated.

Dimensions (mm)

Illuminated Pushbuttons

Standard Bezels

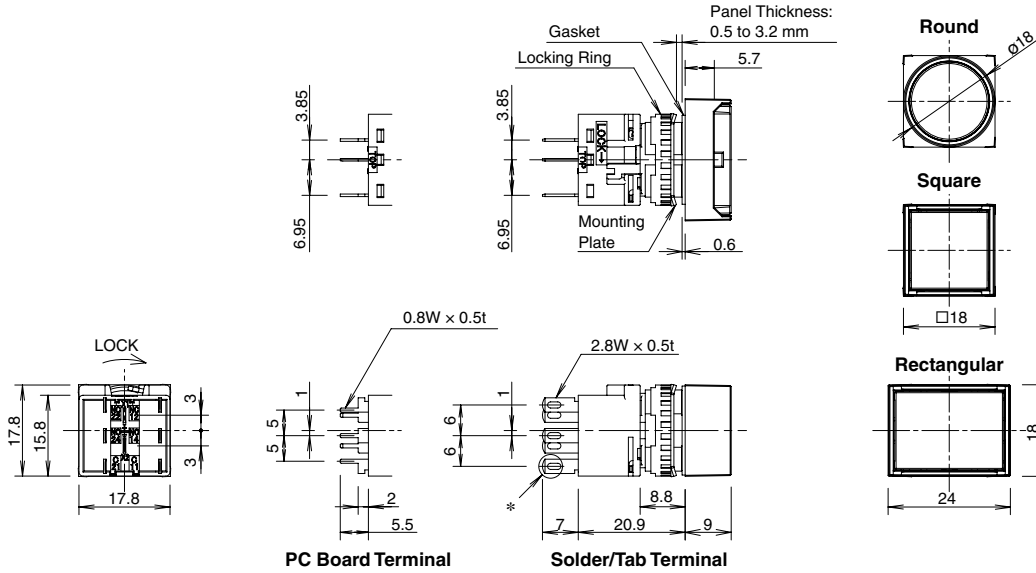

Flush Bezels

SPDT/DPDT Contacts

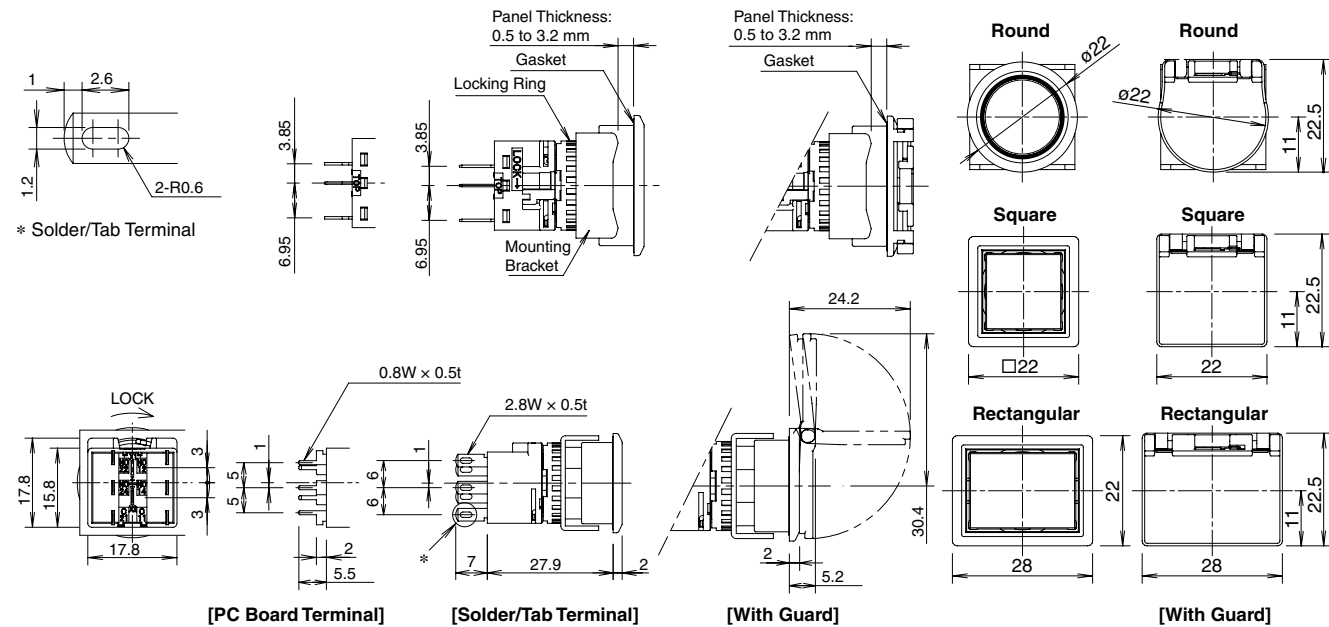

Terminal Arrangement (Bottom View)

Illuminated Pushbuttons

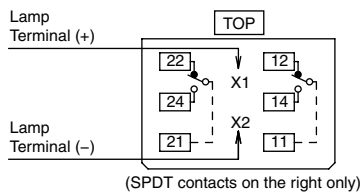

Pilot Lights

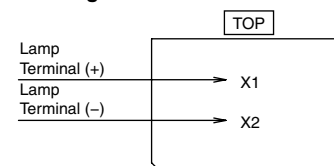

### Pilot Lights

#### Standard Bezels

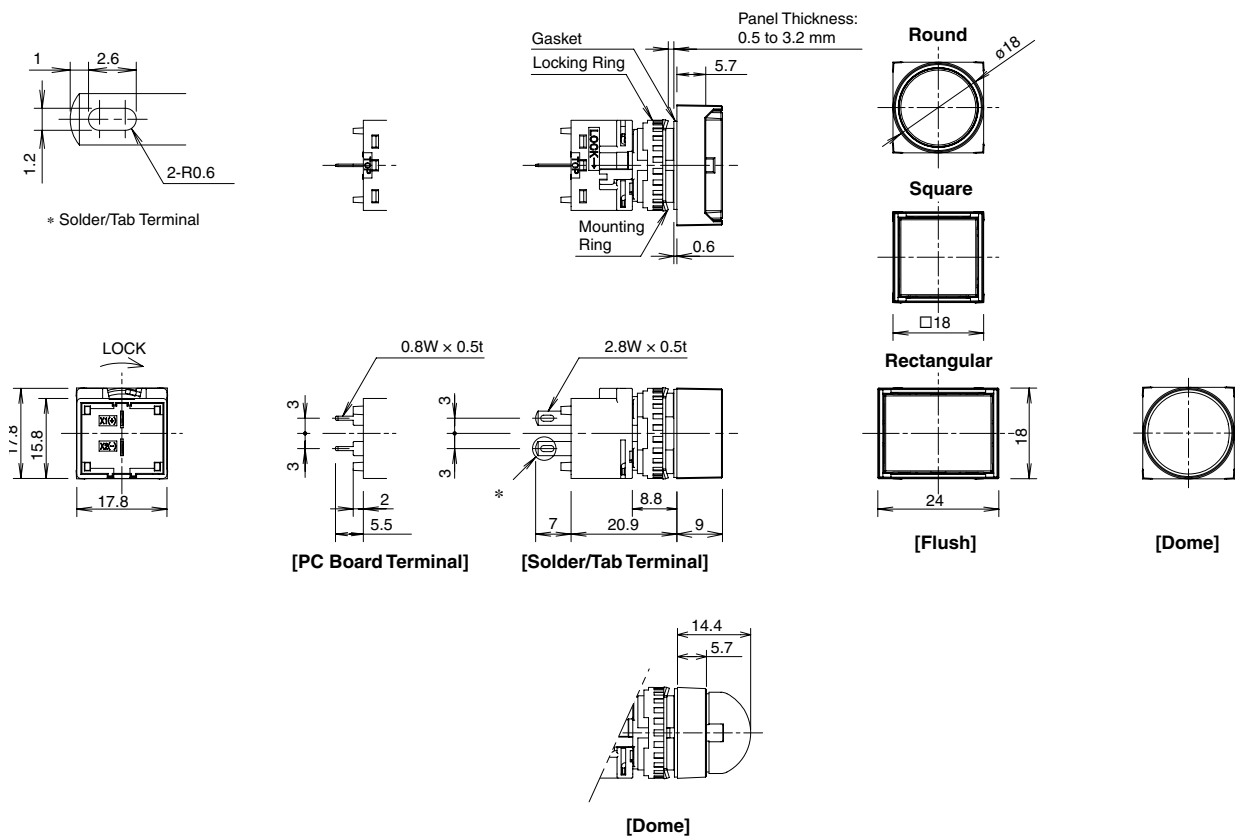

#### Flush Bezels

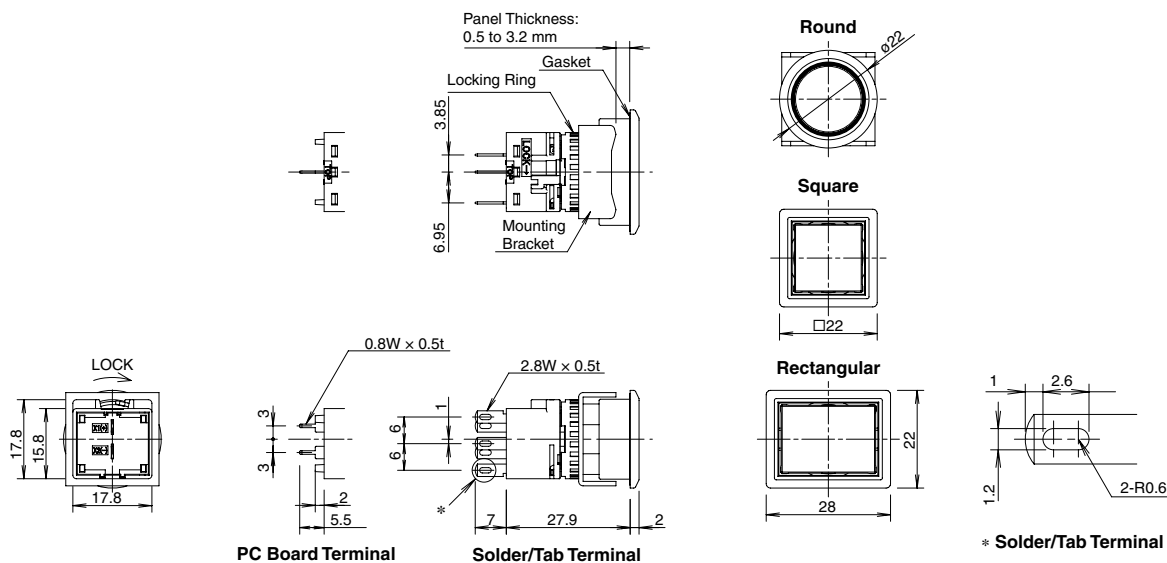

### Non-Illuminated Pushbuttons

#### Standard Bezels

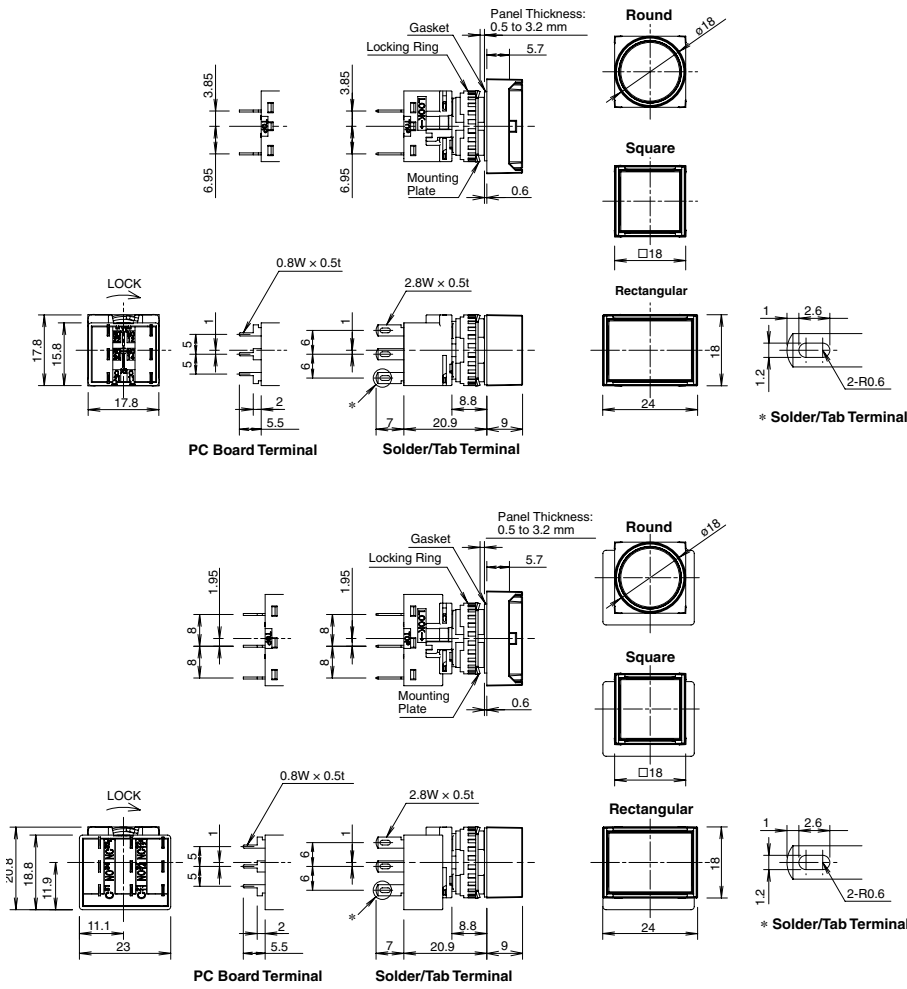

#### Terminal Arrangement (Bottom View)

##### SPDT/DPDT Contacts

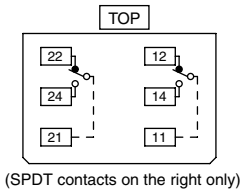

##### 3PDT Contacts

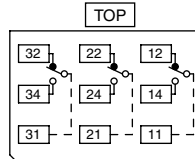

Non-Illuminated Pushbuttons

Flush Bezels

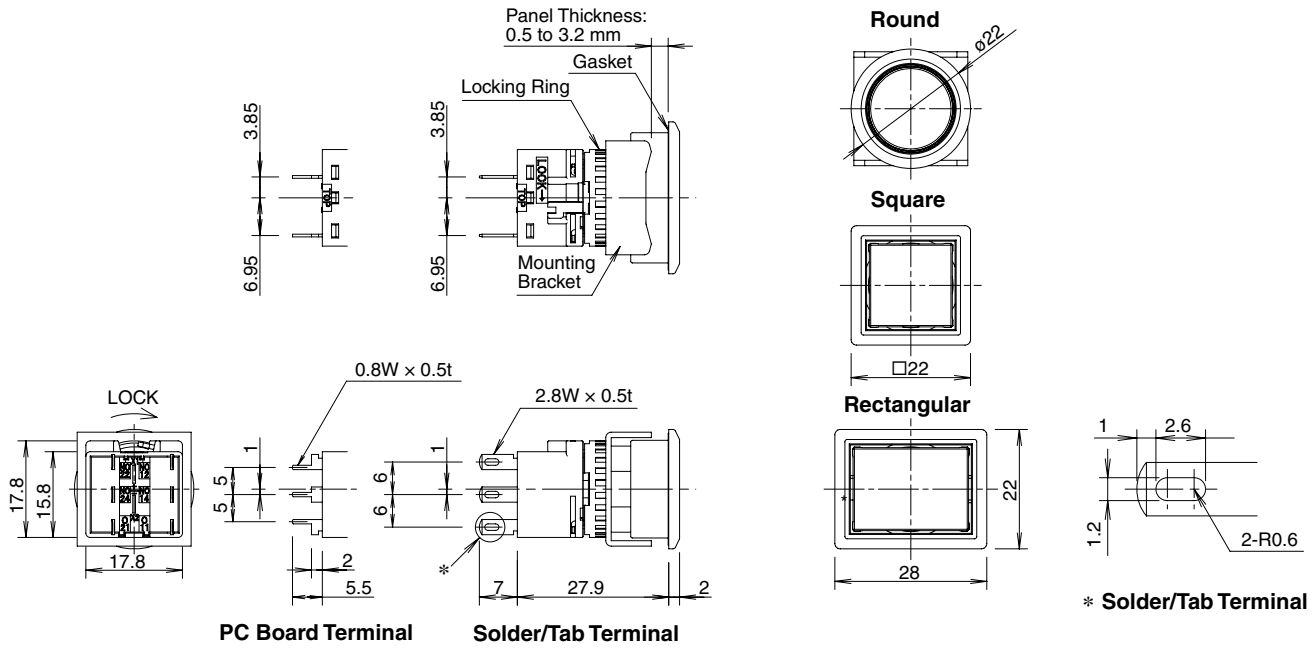

Selector Switches

Standard Bezels

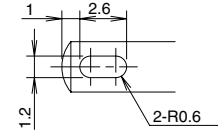

\* Solder/Tab Terminal

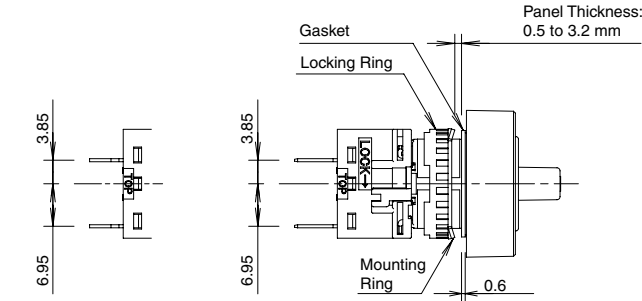

[SPDT/DPDT]

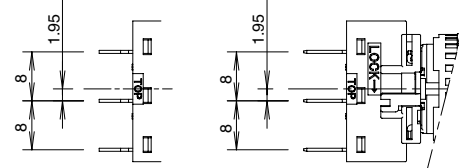

[3PDT]

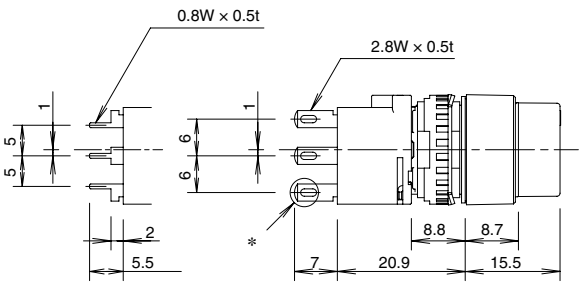

[PC Board Terminal]

[Knob Operator PC Board Terminal]

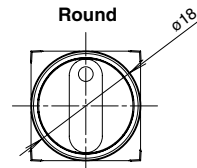

Round

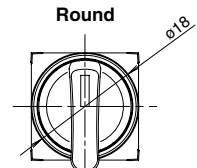

Round

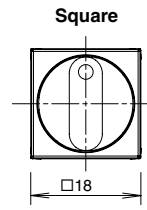

Square

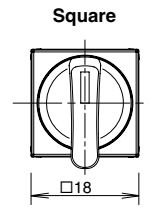

Square

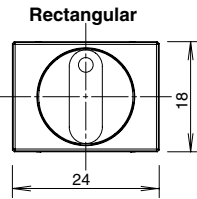

Rectangular

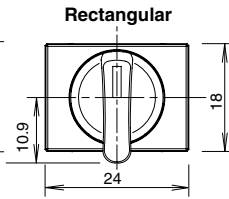

Rectangular

[Knob Operator]

[Lever Operator]

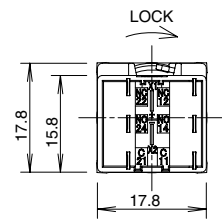

[SPDT/DPDT]

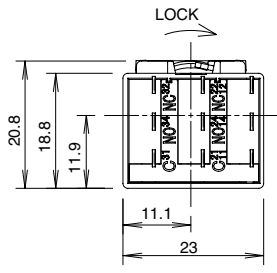

[3PDT]

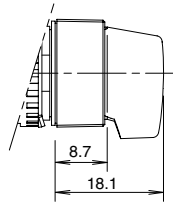

[Lever Operator]



Selector Switches

Flush Bezels

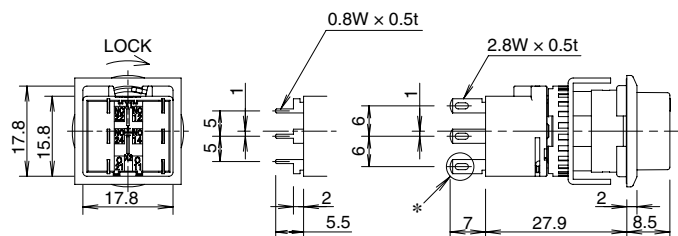
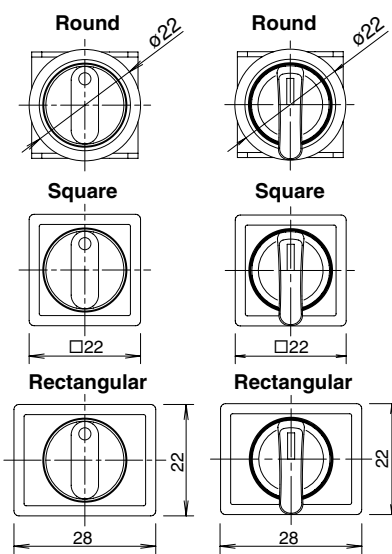
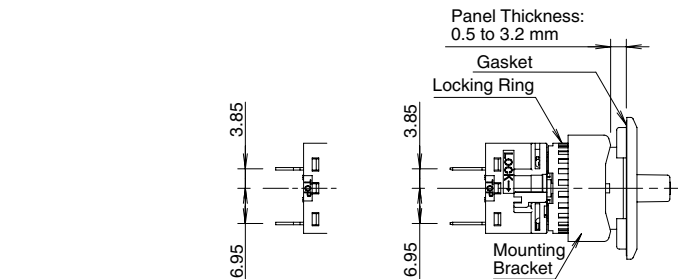

PC Board Terminal Knob Operator Solder/Tab Terminal

Knob Operator Lever Operator

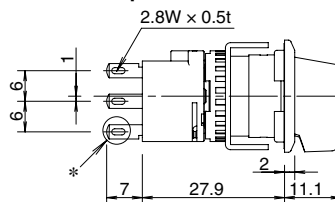

Lever Operator Solder/Tab Terminal

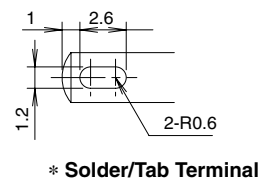

\* Solder/Tab Terminal

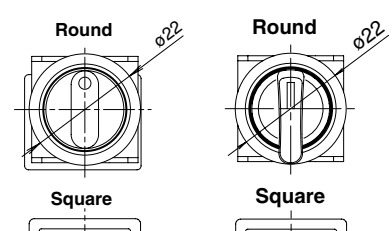
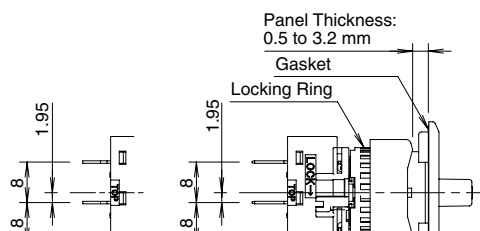

Terminal Arrangement (Bottom View)

SPDT/DPDT Contacts

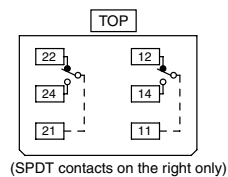

3PDT Contacts

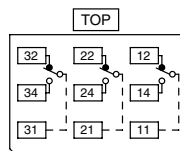

### Illuminated Selector Switches

#### Standard Bezels

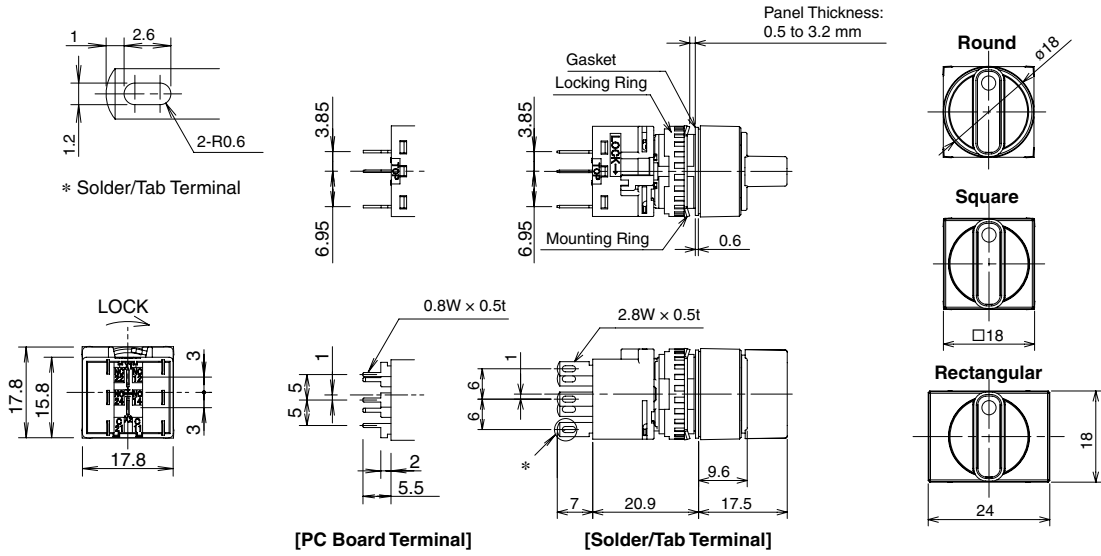

#### Flush Bezels

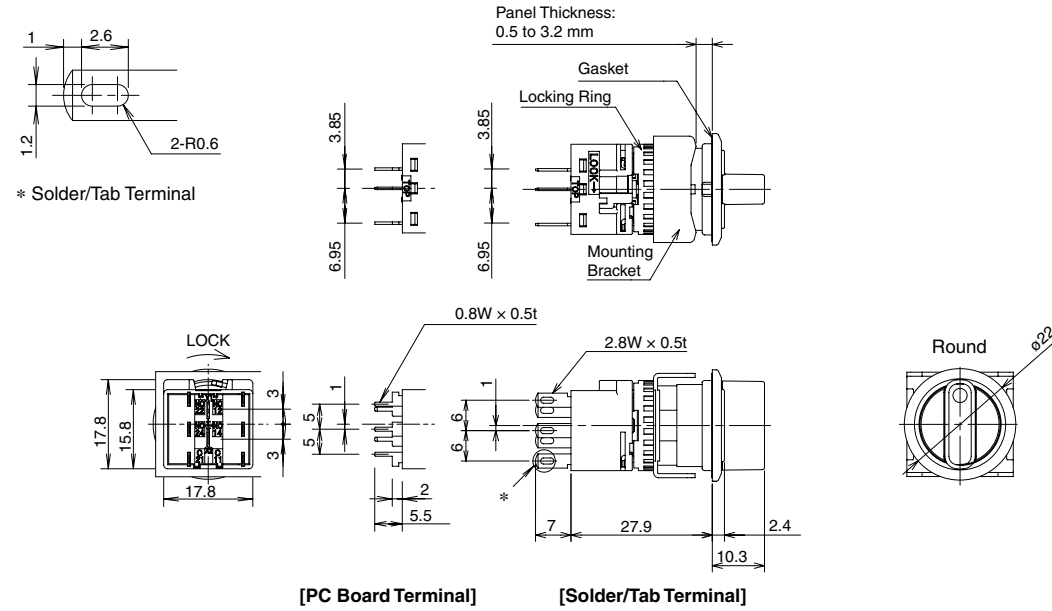

### Terminal Arrangement (Bottom View)

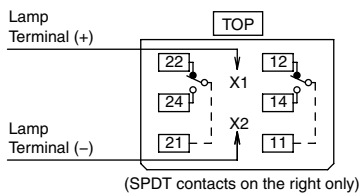

### Key Selector Switches

#### Standard Bezels

With Wave Key

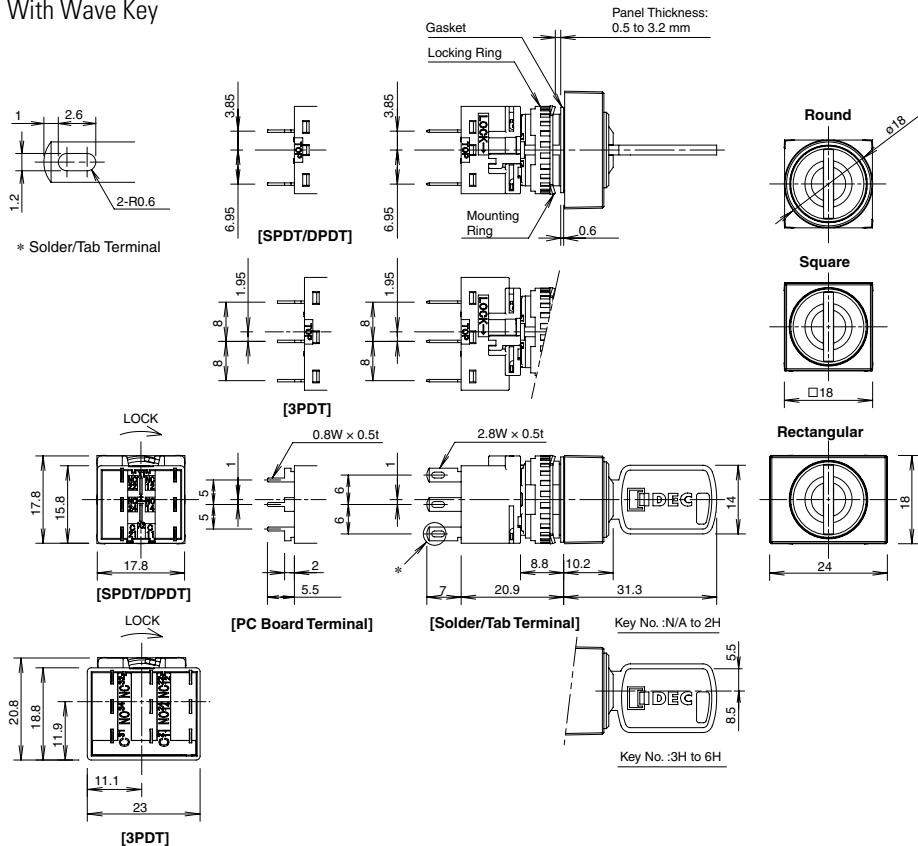

#### With Standard Key

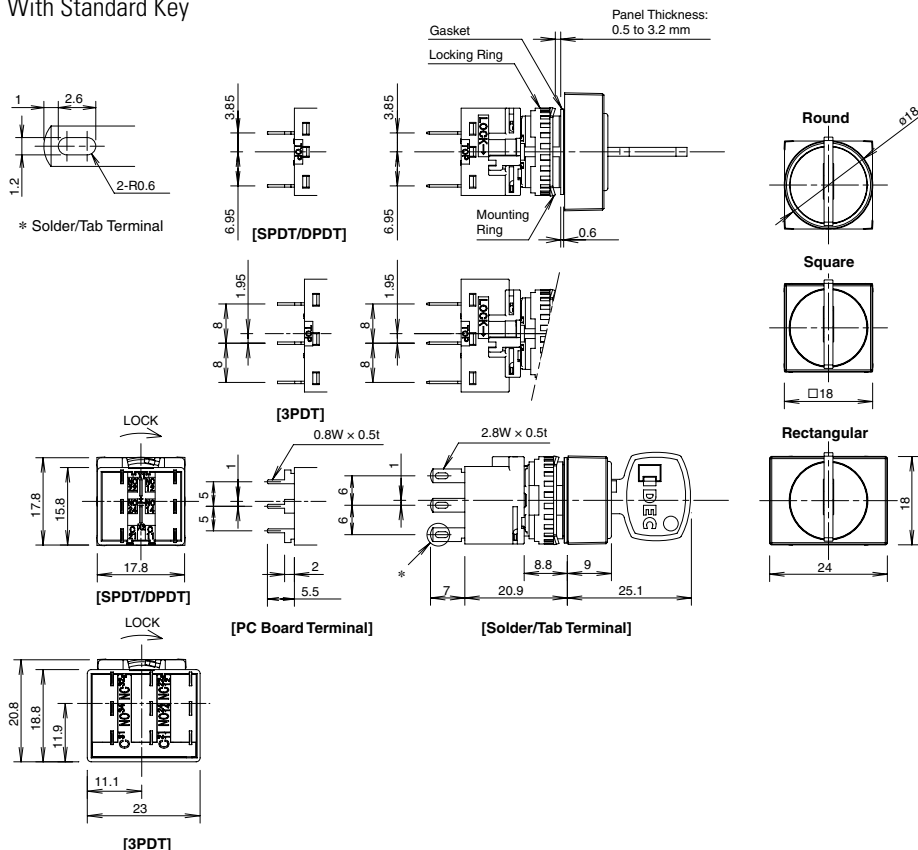

Key Selector Switches

Flush Bezels

With Wave Key

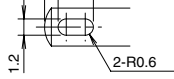

\* Solder/Tab Terminal

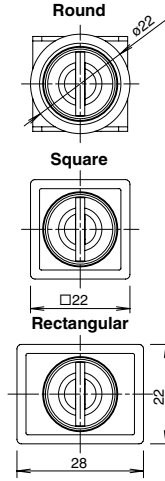
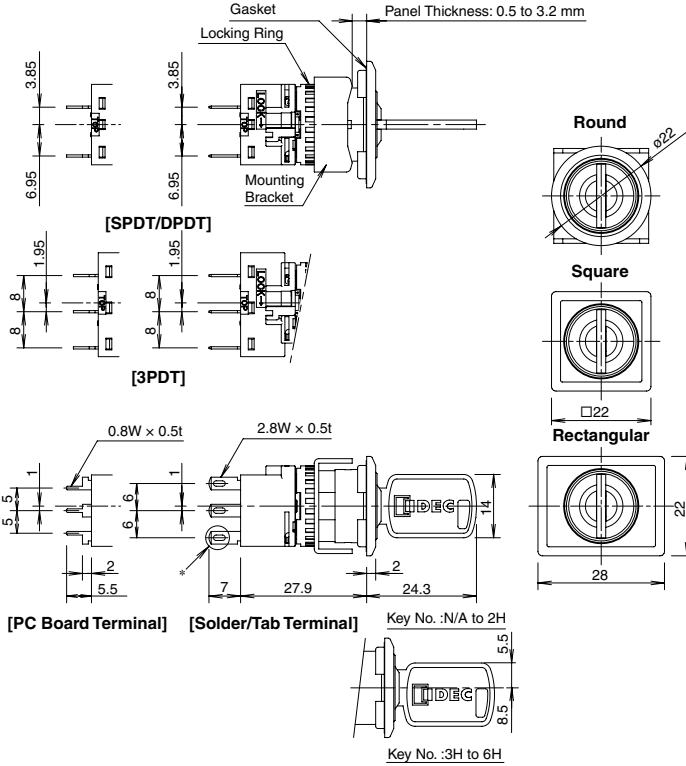
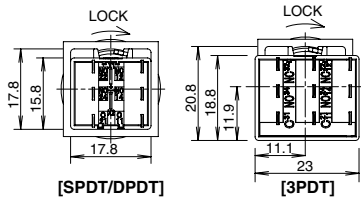

With Standard Key

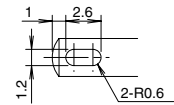

\* Solder/Tab Terminal

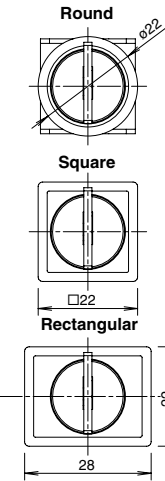
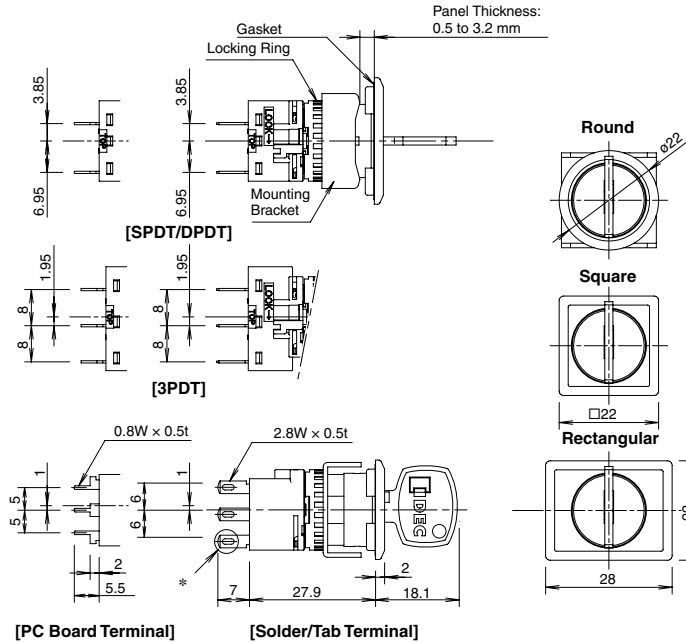
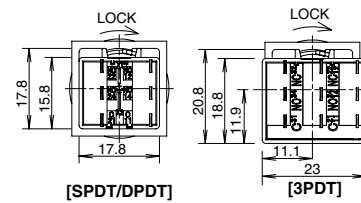

Terminal Arrangement (Bottom View)

SPDT/DPDT Contacts

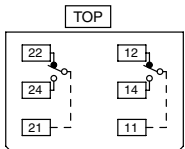

(SPDT contacts on the right only)

3PDT Contacts

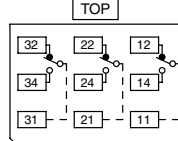

### Lever Switches

Panel Thickness:  
0.5 to 3.2 mm

#### Standard Bezels

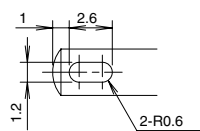

\* Solder/Tab Terminal

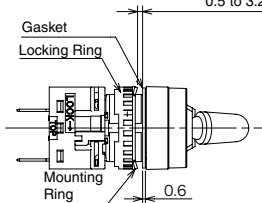
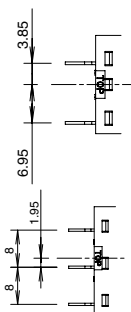

[SPDT/DPDT]

[3PDT]

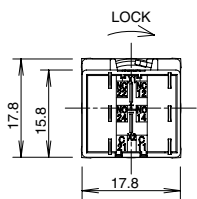

[SPDT/DPDT]

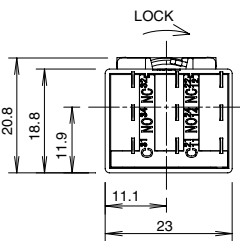

[3PDT]

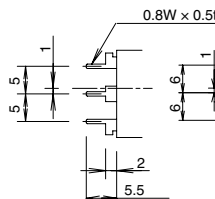

[PC Board Terminal]

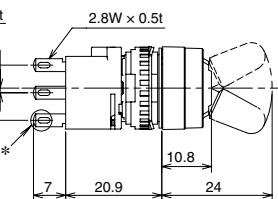

[Solder/Tab Terminal]

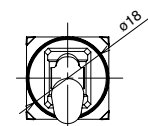

#### Flush Bezels

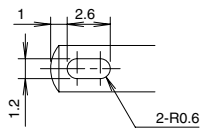

\* Solder/Tab Terminal

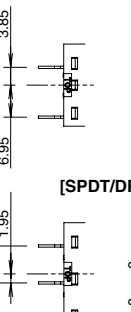

[SPDT/DPDT]

[3PDT]

Panel Thickness:  
0.5 to 3.2 mm

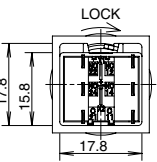
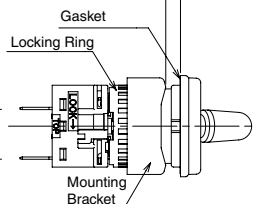

[SPDT/DPDT]

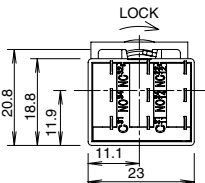

[3PDT]

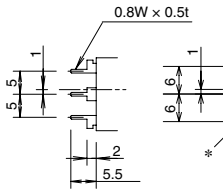

[PC Board Terminal]

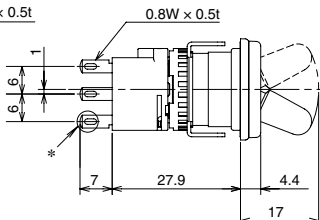

[Solder/Tab Terminal]

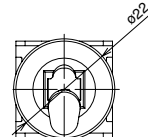

### Terminal Arrangement (Bottom View)

#### SPDT/DPDT Contacts

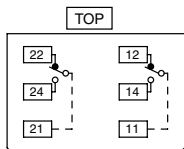

(SPDT contacts on the right only)

#### 3PDT Contacts

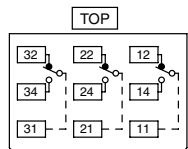

### Buzzers

#### Standard Bezels

IP54

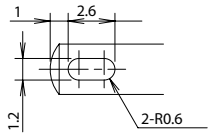

\* Solder/Tab Terminal

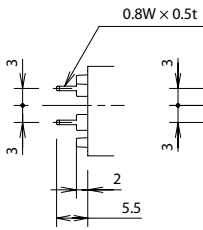
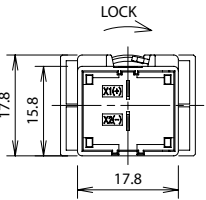
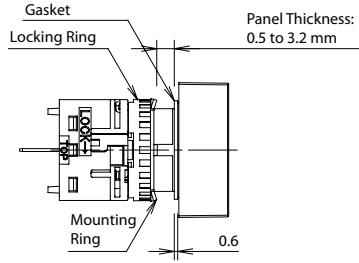

[PC Board Terminal]

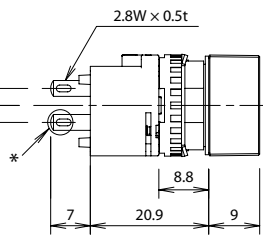

[Solder/Tab Terminal]

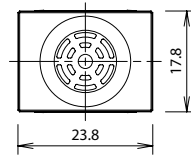

IP40

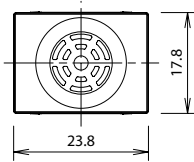
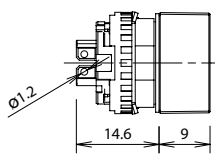
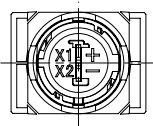
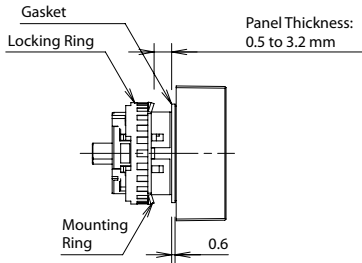

#### Terminal Arrangement (Bottom View)

##### Flush & Standard IP54

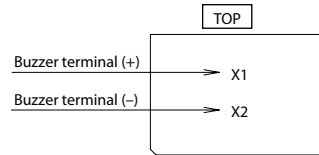

##### IP40

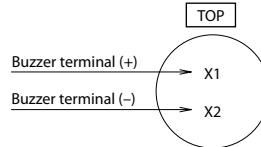

#### Flush Bezels

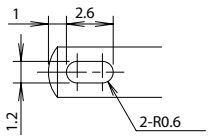

\* Solder/Tab Terminal

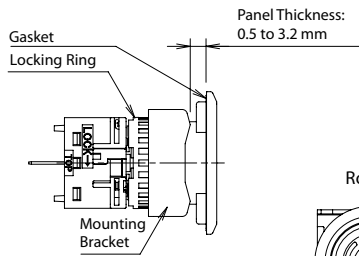

Round

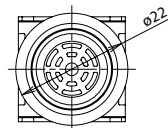

Rectangular

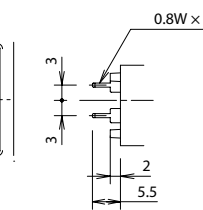
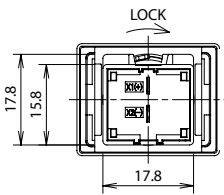
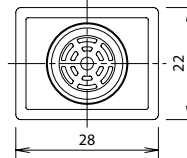



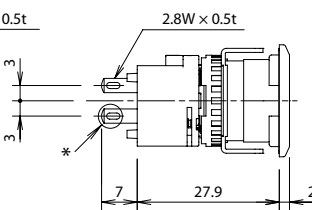



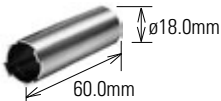
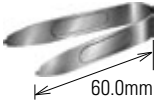

[PC Board Terminal]











[Solder/Tab Terminal]

Accessories

Item	Material	Part Number	Remarks	
Locking Ring Wrench 	Metal: Nickel-plated brass	MT-001	Used to tighten the locking ring when installing the units on to the panel.	
Lens Removal Tool 	Stainless Steel	MT-101	Used to remove the lens or button.	
Switch Guard (180° Spring return) 	For round / square standard units	Guard: Polyacetal Base: Polyarylate	Degree of protection: IP65 Used to protect standard pushbuttons and illuminated pushbuttons from inadvertent operation. See page page 540 for dimensions. With the gasket mounted on the switch, attach the switch guard and mount on the panel.  Note: not applicable for flush mounted units. Select operator with built-in switch guard.	
	For rectangular standard units	AL-KH6SP		
Switch Guard for Single Board Mounting 	For rectangular units	Guard: Polyacetal Base: Polyarylate	Degree of protection: IP65 With the gasket mounted on the switch, attach the switch guard and mount on the panel. See page page 540 for dimensions.	
Rubber Boot for Standard Bezels 1  2  3 	1. For round units	Silicon Rubber	Degree of protection: IP65 See page page 539 for dimensions. See page page 544 for mounting.	
	2. For square units			LB9Z-D2
	3. For rectangular units			LB9Z-D3
Mounting Hole Plug 	Metal Plug: Metal (Zinc diecast) Locking nut: Polyacetal Gasket: Nitrile rubber	AL-BM6	Degree of protection: IP65 Tightening torque: 0.1 to 0.29 N•m See page page 539 for dimensions.	
Mounting Hole Plug 	Rubber	Nitrile rubber (black)	AL-B6	Degree of protection: IP65 See page page 539 for dimensions.

For Standard Bezels

Accessories con't

Item	Material	Part Number	Remarks
Rubber Boot for Flush Bezels			
1 	Silicon Rubber	1. For round units	Degree of protection: IP65 See page page 539 for dimensions. See page page 544 for mounting.
2 		2. For square units	
3 		3. For rectangular units	
For Flush Bezels			
Mounting Hole Plug			
1 	Plug: Polyamide (Black) Gasket: Nitrile rubber Mounting Plate: Stainless Steel	1. For round units	Degree of protection: IP65 Panel thickness: 0.5 to 3.2mm See page page 539 for dimensions.
2 		2. For square units	
3 		3. For rectangular units	
Terminal Cover			
1  2 		1. For SPDT/DPDT contacts	See page page 540 for dimensions.
		2. For 3PDT contacts	



Accessory Dimensions (mm)

Rubber Boot

Standard Bezel

For round units (LB9Z-D1)

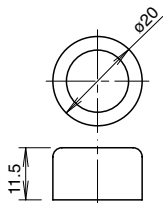

For square units (LB9Z-D2)

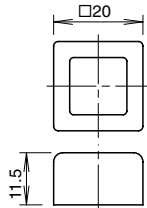

For rectangular units (LB9Z-D3)

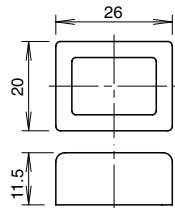

Flush Bezel

For round units (LB9Z-D6)

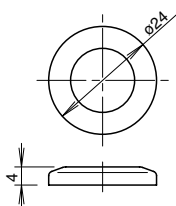

For square units (LB9Z-D7)

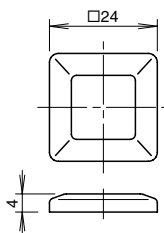

For rectangular units (LB9Z-D8)

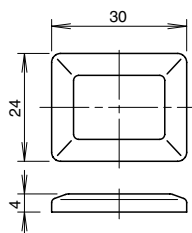

Mounting Hole Plug

Standard Bezels

AL-B6

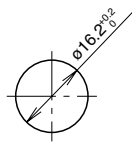
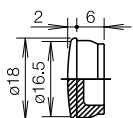

Mounting Hole Layout

AL-BM6

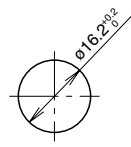
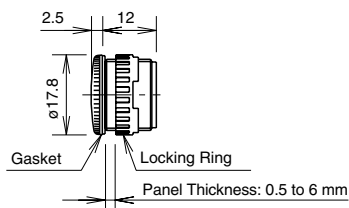

Mounting Hole Layout

Flush Bezels

For round units (LB9Z-BS6)

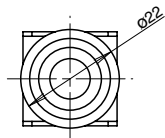

Mounting Hole Layout

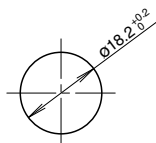

For square units (LB9Z-BS7)

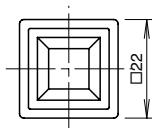

Mounting Hole Layout

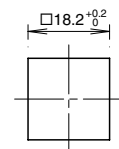

For rectangular units (LB9Z-BS8)

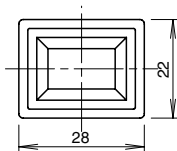

Mounting Hole Layout

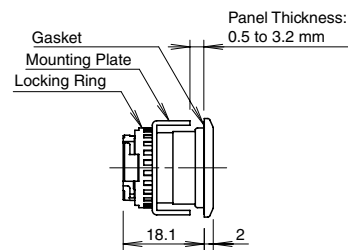
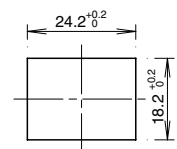

Accessory Dimensions (mm) con't

Terminal Cover

Standard Bezel

For SPDT/DPDT contacts (LB9Z-VL2)

For 3PDT contacts (LB9Z-VL3)

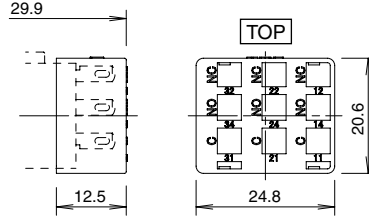
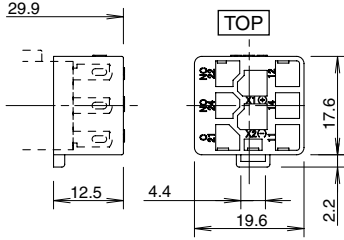

Switch Guard for Standard Bezel Models

For round / square units (AL-K6SP)

For rectangular units (AL-KH6SP)

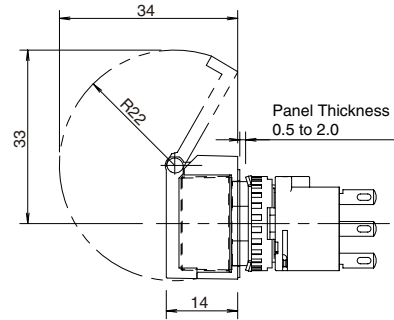
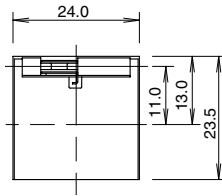
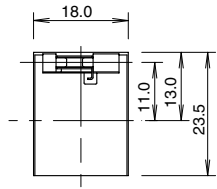

For Single Board Mounting (LA9Z-K3)

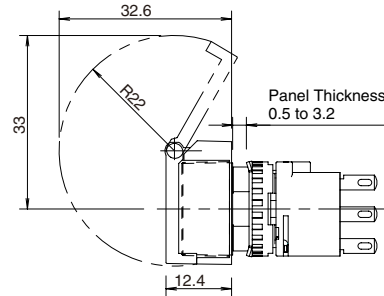
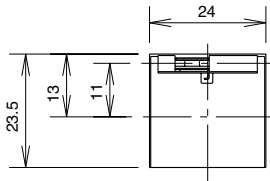

Note: The panel depth is the same for switches with or without switch guards. Both models can be installed on the same PC board.

Standard Key

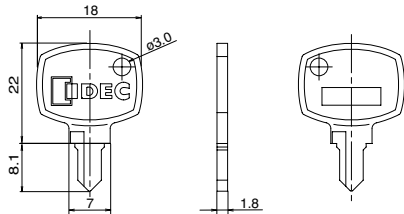

Wave Key

Reversible Wave Key

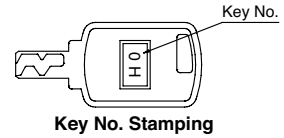
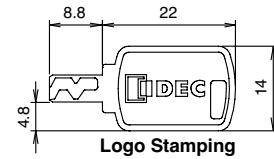

Non-reversible Wave Key

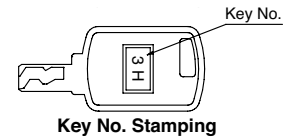
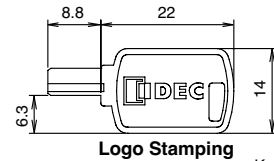

Replacement Parts

Item	Material	Part Number	Remarks
Lens 	For round units	Polyarylate ø15.4 H4mm	AL6M-L <sup>②</sup>
	For square units	Polyarylate □15.4, H4mm	AL6Q-L <sup>②</sup>
	For rectangular units	Polyarylate W21.4 x H4 x D15.4mm	AL6H-L <sup>②</sup>
Button 	For round units	Polyarylate □15.4, H4mm	AB6M-B <sup>②</sup>
	For square units	Polyarylate □15.4, H4mm	AB6Q-B <sup>②</sup>
	For rectangular units	Polyarylate W21.4 x H4 x D15.4	AB6H-B <sup>②</sup>
Marking Plate 	For round units	Acrylic ø13.7 H0.8	AL6M- <sup>②</sup>
	For square units	Acrylic □13.7, H0.8mm	AL6Q- <sup>②</sup>
	For rectangular units	Acrylic W19.7 x H0.8 (0.4) x D13.7mm	AL6H- <sup>②</sup>
Locking Ring 	For all units	Polyamide ø17.9, H3.9mm	LB9Z-LNP
Anti-rotation Ring 	For standard bezel	Metal (Stainless steel) □17.9, t0.6mm	LB9Z-LP1
Anti-rotation Ring 	For flush bezel	Metal (Stainless steel) W21 x H8.2 x D20.6 t0.8mm	LB9Z-LP6
Spare Standard Key 	For key selector switches	Nickel-plated Brass	AS6-SK
Spare Wave key Non-reversible Wave Key  Reversible Wave Key 	For Wave key selector switches	Diecast zinc alloy (nickel plated) W14 x H2 x D30.8mm	LA9Z-SK- <sup>⑤</sup>

LB Series Replacement LED Unit

Item	Rated Operating Voltage	Part Number	②Color Code	Remarks
LED Unit 	DC5V	LB9Z-LED5 <sup>②</sup>	A G PW R S	8. Specify color code in place of the ② in the part number. R: Red, G: Green, A: Amber, S: Blue, PW: White 9. All illuminated LB series contain an LED unit. 10. Use a white (PW) LED unit for yellow (Y) illumination.
	AC/DC12V	LB9Z-LED1 <sup>②</sup>		
	AC/DC24V	LB9Z-LED2 <sup>②</sup>		

**Precautions & Instructions**

**! Safety Precautions**

- Turn off the power to the LB series control units before installation, removal, wiring, maintenance, and inspection. Failure to turn power off may cause electrical shocks or fire hazard.
- To avoid burning your hand, use the lamp holder tool when replacing the lamps.
- For wiring, use wires of a proper size to meet voltage and current requirements. Solder correctly according to the instructions in "Wiring" and "Notes on Terminal Cover." Improper soldering may cause overheating and create a fire hazard. Also, when using tab terminals, use receptacles of appropriate size.

**Instructions**

**Wiring**

1. Solder the terminals at 350°C within 3 seconds using a 60W soldering iron. Sn-Ag-Cu type is recommended. When soldering, do not touch the LB series with the soldering iron. Also ensure that no tensile force is applied to the terminals. Do not bend the terminal or apply excessive force to the terminal.
2. Use non-corrosive liquid flux.

**Terminal Cover**

Solder/tab terminal

Insert the terminal cover into the contact block with the TOP markings on the contact block and the terminal cover in the same direction.

Note: When wiring, insert the lead wires into the terminal cover holes before soldering. After wiring, terminal covers cannot be installed.

Standard Bezel



Flush Bezel



**Operating Environment**

- Do not use the LB series where corrosive gases exist or under an environment exceeding the operating temperature and humidity ranges. Otherwise, damage such as contact failure or change of the surface color may occur.
- Major parts of the switch are plastic. Scratches or damage may occur when scraped with a sharp object or if excessive load or shock is applied. Note that this may cause operation and appearance failure of the operator and bezel.
- Application of detergent, cutting oil, or special chemicals to the switch may result in operation and/or appearance failure such as a change in surface color.

**Handling**

Contacts (micro switch)

When using NC (normally closed) and NO (normally open) contacts of the same microswitch, avoid connections of different voltages, or connections of different types of power supplies. Failure to observe this instruction may cause a short-circuit.

**Removing and Installing the Contact Block**

3. Turn the locking lever on the contact block in the direction opposite to the arrow on the housing. Then the contact block can be removed.
4. Insert the contact block with the TOP markings on the contact block and the operator placed in the same direction. Then lock the units, turning the locking lever in the direction of the arrow.

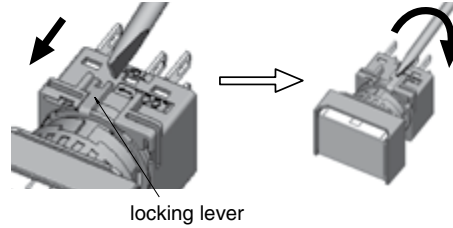

**Panel Mounting**

Remove the contact block from the operator. Insert the operator into the panel cut-out from the front, then install the contact block to the operator.

Standard Bezel

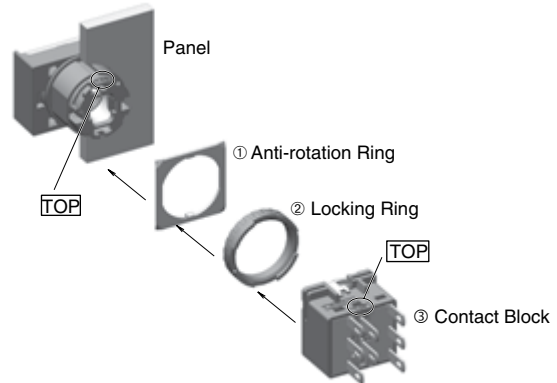

Flush Bezel

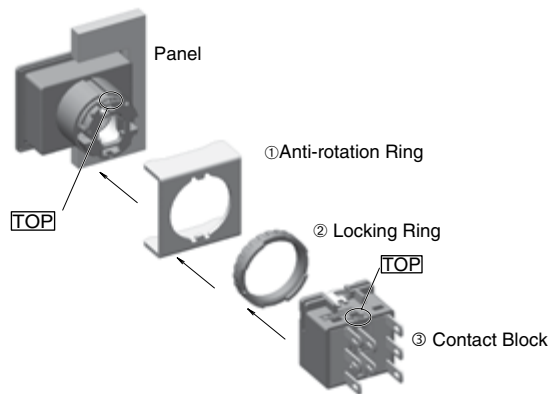

**Notes on Mounting**

Use the optional ring wrench (MT-001) to mount the operator onto the panel. Tightening torque should not exceed 0.7 N·m. Do not use pliers. Excessive tightening will damage the locking ring.

**Replacing the Lens**

**Standard Bezel**

From the opposite side of the TOP marking, remove the operator (lens, marking plate, and lens holder) using the optional lens removal tool (MT-101) by gripping the recesses of the color lens. Removing from the TOP side may damage the metallic bezel.

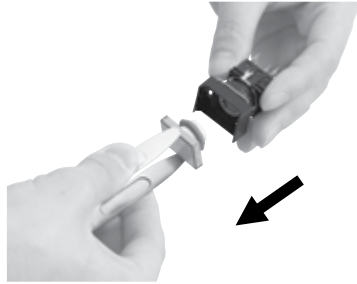

Removing the Operator (standard bezel)

**Flush Bezel**

From the opposite side of the TOP marking, push the tip of a flat screwdriver to the groove of the color lens and pull out the operator (lens, marking plate, lens holder). Removing from the TOP side may damage the metallic bezel.



Removing the Operator (flush bezel)

**Replacing the Marking Plate**

5. Remove the marking plate by pushing the lens from the back to disengage the latches between the lens and holder, using the screwdriver as shown below.



Note: A transparent film inside the lens holder is attached to the unit to make it waterproof and cannot be removed.

6. Insert a marking plate into the color lens, and press the lens onto the lens holder to engage the latches. Pay attention to the orientation of the marking plate.

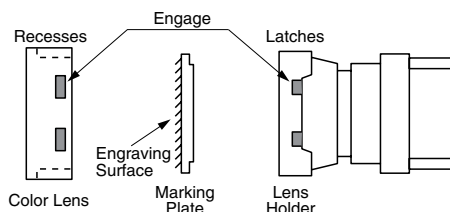

**Lens Unit and Contact Block Installation**

To insert the lens unit into the operator, press in the lens unit by aligning the latch on the operator with the latch on the lens unit.

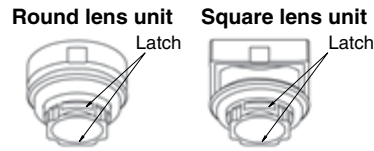

**Standard Bezel**

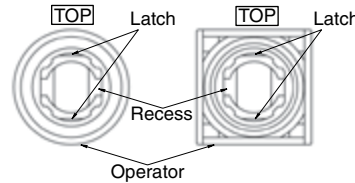

**Flush Bezel**

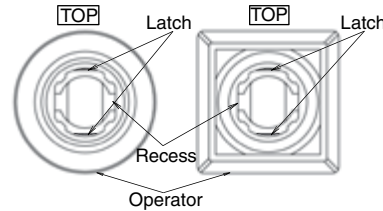

**Marking Plates and Films**

Illuminated pushbuttons and pushbuttons with illuminated lens can have legends and symbols engraved on the marking plates, or printed film can be inserted under the lens for labelling purposes.

**Marking Plate and Marking Film Size**

Lens	Round	Square	Rectangular
Built-in Marking Plate			
Applicable Marking Film			
	<ul style="list-style-type: none"> <li>Film thickness: 0.1mm per film</li> <li>Marking film is not included.</li> <li>Recommended marking film: Polyester film</li> </ul>		

**Marking Plate and Film Insertion Order**

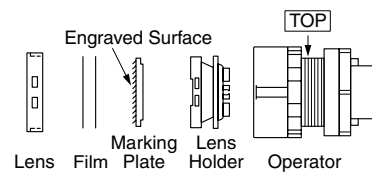

The marking plate must be engraved on the side specified above. Pay attention to the orientation of the marking plate.

**Replacing the LED Unit**

The LED unit can be replaced by pulling the lens unit out of the contact block.

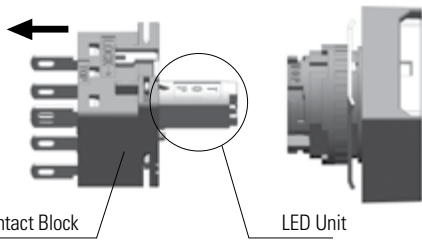

**Orientation of the LED unit**

Insert the LED unit into the contact block with the TOP markings on the contact block and LED unit in the same orientation.

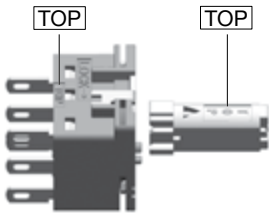

**Notes on replacing the LED Unit**

- When replacing the LED unit, make sure that static electricity is not applied.
- Make sure that the LB series has cooled down before replacing the LED unit.
- To avoid getting burned, be careful not to touch the unit while it is still hot.

**Notes on Using Quick Connect Terminals**

7. Use #110 tab quick connects, 0.5mm-thick.
8. When connecting the terminals on the left and center, make sure that surfaces of the quick connects face each other. Otherwise, a short-circuit may occur.

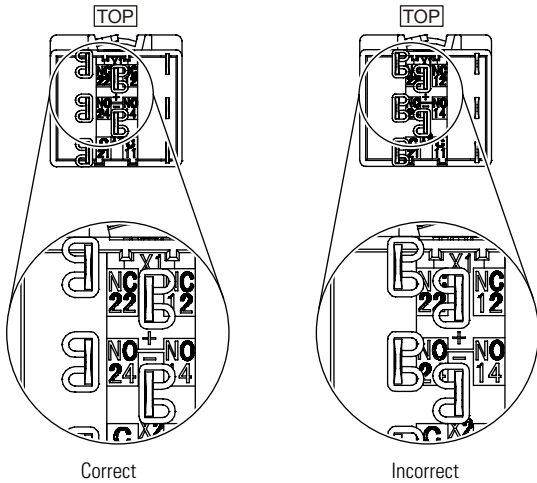

9. Apply only horizontal force against the panel to the tab. The switch may be damaged if a force other than a horizontal force is applied.

**Installing Rubber Boots**

When using the switches in environments subject to splashing water or an excessive amount of dust, make sure to use an optional rubber boot. As shown in the drawing on the right, ① remove the gasket from the operator, and ② attach the rubber boot from the front (button side).

**Standard Bezels**

For rectangular and square units, pull the seals out of the rubber boot and place them around the operator sleeve as shown below. Make sure that the seals are not twisted or tucked inside and that the gasket is removed, otherwise waterproof and dustproof characteristics are not ensured.

**How to Install the Rubber Boot**

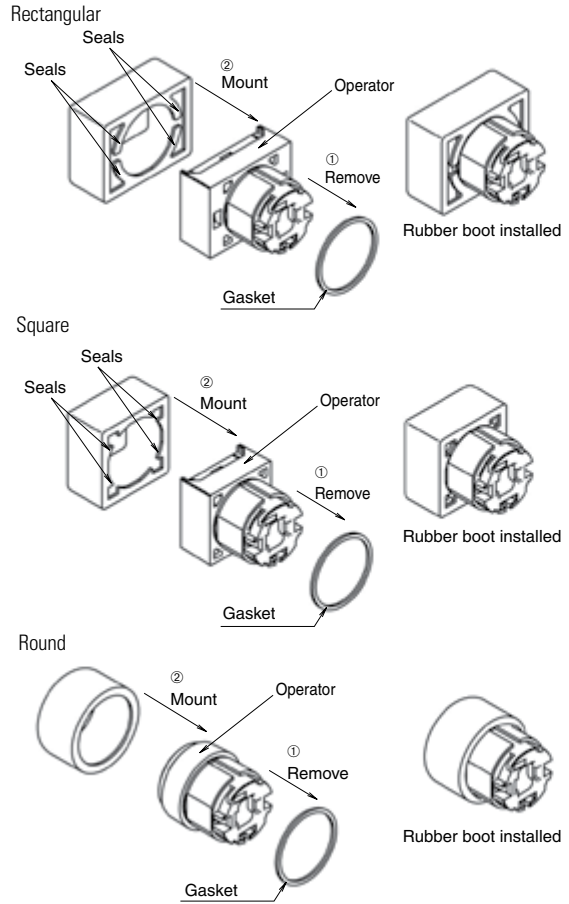

**Flush Bezels**

Mount the rubber boot so that the protrusion at the bottom surface of the operator fits with the recess on the operator, placing the rubber boot all around the operator sleeve. Make sure that the protrusion on the rubber boot and the recess on the operator fit correctly, otherwise, the waterproof and dustproof characteristics are not ensured.

**How to Install the Rubber Boot**

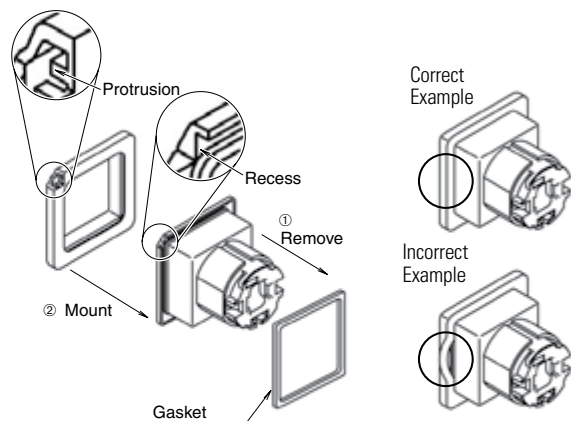

Note: Install the rubber boot before mounting the unit to the panel.

**Maintained Pushbuttons**

Do not replace the buttons when the pushbutton is in the maintained position as it may damage the internal mechanism. Also, do not remove the contact block with the button in the maintained position. The contact may not operate properly when the contact block is remounted.

**Pushbuttons and Illuminated Pushbuttons with Switch Guard**

Do not apply force to the switch guard when the switch guard is not attached to a panel. When opening the switch guard, do not open more than 180°. The hinge may break.

**Selector Switches**

When turning the operator or key, make sure that they are turned to the correct position.

**Selector Switches with Key**

Observe the following instructions to prevent malfunction or damage.

- Do not remove the key from any key retained position.
- In addition to the standard key (key number 0H), six other key numbers are available. Use a key matching the number of the key cylinder. The standard key does not have a key number indication.
- Keys are available in two types.  
Key numbers 0H (standard), 1H, and 2H are reversible keys which can be inserted in two ways.  
Key numbers 3H, 4H, 5H, and 6H are non-reversible keys. Make sure of correct insertion direction.

**Single Board Mounting**

The LB series can be used for single board mounting.

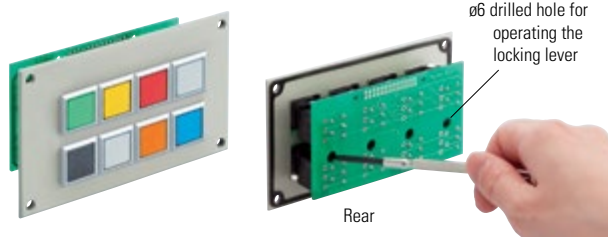

**Installing and Removing Contact Blocks**

Turn the locking lever to install and remove contact blocks on a PC board using a screwdriver from a hole in the PC board. Determine the location of the switches so that the locking lever can be operated.

**Mounting Holes and Assembly Procedure**

Drill mounting holes in the panel as shown on the right. When the units are mounted together, provide adequate clearance.

**Panel Cut-out**

Standard Bezels (LB1/LB2/LB3/LB4)

SPDT/DPDT Contacts

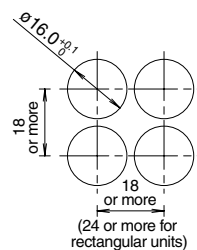

3PDT Contacts

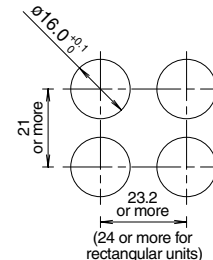

Flush Bezels

SPDT/DPDT Contacts

LB6/LB6M

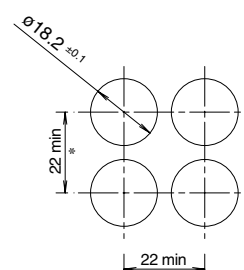

3PDT Contacts

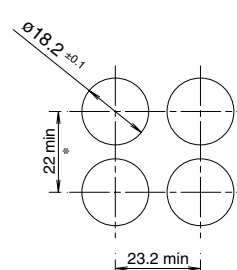

LB7/LB7M

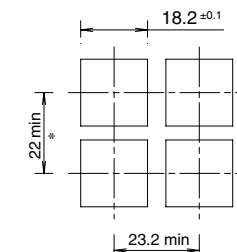
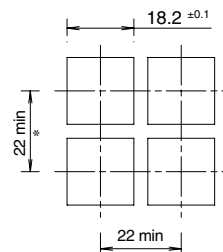

LB8/LB8M

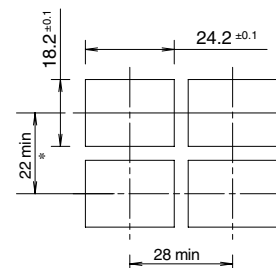
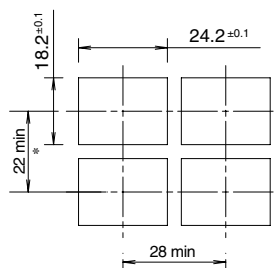

\* 45mm minimum for switches with guard

All dimensions in mm.

**Assembly Procedure**

1. Install the operator to the panel.
2. Mount the contact block to the operator from the back of the panel.
3. Turn the locking lever to lock the contact block.
4. Insert a PC board and solder.

Notes:

1. Make sure that each terminal is inserted into the PC board correctly.
2. Do not apply tensile force to the connector cable for an extended period of time.
3. Do not expose the contact block to water.
4. Ensure that the contact blocks are locked when installed on the operators.



### Switch Engraving Order Form – LB Series

Copy this order form and use it to specify Letter Height, Maximum Number of Lines and Text to be engraved.  
 To insure engraving accuracy, fax it to your IDEC representative or Distributor.

Your Company: \_\_\_\_\_  
 Name: \_\_\_\_\_  
 Address: \_\_\_\_\_  
 PO: \_\_\_\_\_

Telephone: \_\_\_\_\_  
 Fax: \_\_\_\_\_  
 Email: \_\_\_\_\_  
 Part Number to be Engraved: \_\_\_\_\_

Please check one of the boxes below to indicate your choice of engraving options:



	# of Lines	Letter Height	Max. Characters Per Line
<input type="checkbox"/>	1	5/32	6
<input type="checkbox"/>	2	5/32	6
<input type="checkbox"/>		1/8	6
<input type="checkbox"/>	3	1/8	6
<input type="checkbox"/>	4	N/A	

	# of Lines	Letter Height	Max. Characters Per Line
<input type="checkbox"/>	1	5/32	5
<input type="checkbox"/>	2	5/32	5
<input type="checkbox"/>		1/8	6
<input type="checkbox"/>	3	1/8	6
<input type="checkbox"/>	4	N/A	

	# of Lines	Letter Height	Max. Characters Per Line
<input type="checkbox"/>	1	5/32	3
<input type="checkbox"/>		1/8	3
<input type="checkbox"/>	2	Custom*	
<input type="checkbox"/>	3	Custom*	
<input type="checkbox"/>	4	N/A	

\*Engraving is possible, but character size will be smaller than standard sizes.



- Above mentioned specifications hold true for standard size pushbuttons (round, square and rectangular).
- Engraving is done on the button itself for non-illuminated push buttons and on marking plate for illuminated pushbuttons and pilot lights.
- Please enter text exactly how you want it engraved, take care to emphasize capital or small letters.

Enter text to be engraved:

Line 1: \_\_\_\_\_  
 Line 2: \_\_\_\_\_  
 Line 3: \_\_\_\_\_  
 Line 4: \_\_\_\_\_

#### Sample Letter Sizes

1/8 Letters: **OPEN**  
 5/32 Letters: **OPEN**

For IDEC Internal Use Only:

Work Order #: \_\_\_\_\_



**L6 Series – Miniature Switches and Pilot Devices**

**Key features:**

- 5/8" (16mm) mounting holes
- Locking lever removable contact blocks
- Solder terminal or PCB terminal options
- Available assembled or as sub-components
- Worldwide approvals
- Incandescent or LED illumination
- Snap action contacts



UL Recognized  
File No. E55996



CSA Certified  
File No. LR21451



Registration No. R9551089 (E-stops)  
Registration No. J9551458 (all other switches)  
Registration No. R95650511 (Pilot Lights)



Contact Ratings	Conforming to Standards	EN60947-1, EN60947-5-1, VDE0660-200, UL508, CSA C22-2 NO.14																																												
	Operating Temperature	Operation: -25 to +55°C (without freezing), 45 to 85% RH Storage: -30 to +80°C (without freezing)																																												
	Vibration Resistance	5 to 55Hz, 1.0 peak-peak amplitude max																																												
	Shock Resistance	Operating limit: 100 m/sec <sup>2</sup> (approximately 10G) Damage limit: 1000 m/sec <sup>2</sup> (approximately 100G)																																												
	Mechanical Life	Momentary pushbuttons 2,000,000 operations minimum All others: 250,000 operations minimum																																												
	Degree of Protection	IP65 (conforming to IEC 60529)																																												
	Dielectric Strength	Switch unit: between live and ground: 2500 volt AC, 1 minute between terminals of different poles: 2500 volt AC, 1 minute between terminals of same pole: 1000 volt AC, 1 minute Illumination unit: between live part and ground: 2500 volt AC, 1 minute																																												
	Insulation Resistance	100MΩ minimum (using 500V DC megger)																																												
	Rated Insulation Voltage	250V AC/DC																																												
	Rated Thermal Current	Gold Contacts (pcb): 3A Silver Contacts (solder): 5A																																												
	Contact Resistance	50Ω maximum initial value																																												
	Rated Operating Current	<table border="1"> <thead> <tr> <th rowspan="2"></th> <th colspan="3">Silver Contacts (Solder Terminals)</th> <th colspan="2">Gold Clad Contacts (PCB terminals)</th> </tr> <tr> <th>30V</th> <th>125V</th> <th>250V</th> <th>30V</th> <th>125V</th> </tr> </thead> <tbody> <tr> <td>AC resistive</td> <td>—</td> <td>5A</td> <td>2A</td> <td>AC inductive</td> <td>-</td> <td>0.1A</td> </tr> <tr> <td>AC inductive</td> <td>—</td> <td>2A</td> <td>1.5A</td> <td>DC resistive</td> <td>0.1A</td> <td>—</td> </tr> <tr> <td>DC resistive</td> <td>3A</td> <td>0.4A</td> <td>—</td> <td></td> <td></td> <td></td> </tr> <tr> <td>DC inductive</td> <td>1A</td> <td>0.2A</td> <td>—</td> <td></td> <td></td> <td></td> </tr> </tbody> </table>				Silver Contacts (Solder Terminals)			Gold Clad Contacts (PCB terminals)		30V	125V	250V	30V	125V	AC resistive	—	5A	2A	AC inductive	-	0.1A	AC inductive	—	2A	1.5A	DC resistive	0.1A	—	DC resistive	3A	0.4A	—				DC inductive	1A	0.2A	—						
		Silver Contacts (Solder Terminals)				Gold Clad Contacts (PCB terminals)																																								
		30V	125V	250V	30V	125V																																								
AC resistive	—	5A	2A	AC inductive	-	0.1A																																								
AC inductive	—	2A	1.5A	DC resistive	0.1A	—																																								
DC resistive	3A	0.4A	—																																											
DC inductive	1A	0.2A	—																																											
Minimum Recommended Load (reference value for silver contacts)	5V AC/DC, 1mA																																													
Terminal Style	0.110" Solder Tab /PCB																																													
Contact Form	Snap Action, Double Throw																																													
Contact Material	Solder Tab: Pure Silver /PCB: Gold Plated Silver																																													
Electrical Life (at full load)	Momentary pushbuttons: 100,000 operations minimum (1800 operations / hour) All others: 100,000 operations minimum (1200 operations / hour)																																													
Lamp Ratings	Lamp Current Draw	5V DC LED: 8mA 6V AC/DC LED: 7mA 12V AC/DC LED: 8mA 24V AC/DC LED: 8mA 120V AC = 8mA			6V AC/DC incandescent: 100 mA 12V AC/DC incandescent: 50 mA 24V AC/DC incandescent: 25 mA																																									
	Lamp Life	Incandescent: 2000 hours./LED 50,000 hours. (on pure DC, half-life intensity)																																												

Switches & Pilot Devices

Signaling Lights

Relays & Sockets







Timers

Contactors

Terminal Blocks



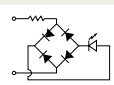
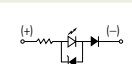

Circuit Breakers

**Built-in LED Lamp Ratings**

Model	LFTD-5②	LFTD-1②	LFTD-2②	LFTD-H2②
Lamp Base	SX6S/8x5.4			
Rated Voltage	5V DC	12V AC/DC	24V AC/DC	120V AC
Operating Voltage	5V DC ±5%	12V AC/DC ±10%	24V AC/DC ±10%	120V AC ±5%
Current Draw	AC	9mA	9mA	8mA
	DC	8mA	8mA	—
Color Code ②	Specify a color code in place of ② in the Part No: A (amber), G (green), R (red), S (blue), W (white), Y (yellow)			
Lamp Base Color	Same as illumination color			
Voltage Marking	Stamped on the lamp base			
Life (reference value)	Approx. 50,000 hours			
Internal Circuit	A, R, W, Y	A, R, W, Y		 LED Chip  Protection Diode  Zener Diode
				
	G, S	G, S		
				

**Non-Illuminated Pushbuttons (Assembled)**

**Non-Illuminated Pushbuttons**

Style	Operation	Contact	Terminal Style	
			Solder Tab	PCB
	Momentary	SPDT	HA1B-M2C5-①	HA1B-M2C1V-①
		DPDT	HA1B-M2C6-①	HA1B-M2C2V-①
	Maintained	SPDT	HA1B-A2C5-①	HA1B-A2C1V-①
		DPDT	HA1B-A2C6-①	HA1B-A2C2V-①
	Momentary	SPDT	HA2B-M1C5-①	HA2B-M1C1V-①
		DPDT	HA2B-M1C6-①	HA2B-M1C2V-①
	Maintained	SPDT	HA2B-A1C5-①	HA2B-A1C1V-①
		DPDT	HA2B-A1C6-①	HA2B-A1C2V-①
	Momentary	SPDT	HA2B-M2C5-①	HA2B-M2C1V-①
		DPDT	HA2B-M2C6-①	HA2B-M2C2V-①
	Maintained	SPDT	HA2B-A2C5-①	HA2B-A2C1V-①
		DPDT	HA2B-A2C6-①	HA2B-A2C2V-①
	Momentary	SPDT	HA1B-M3C5-①	HA1B-M3C1V-①
		DPDT	HA1B-M3C6-①	HA1B-M3C2V-①
	Maintained	SPDT	HA1B-A3C5-①	HA1B-A3C1V-①
		DPDT	HA1B-A3C6-①	HA1B-A3C2V-①

**① Button Color Codes**

Color	Code	Color	Code
Black	B	Blue	S
Green	G	White	W
Red	R	Yellow	Y

- In place of ① specify Button Color Code from table.
- Illuminated (translucent) style lenses also available, specify as such: instead of LA1B-M1C5-① use LA1B-M1C5L-② in place of ② (specify Lens Color Code from next page.)
- PCB terminal models also available with silver contacts (change "1" or "2" to "5" or "6" respectively, ie LA1B-M1C1V-① becomes LA1B-M1C5V-①).

Non-Illuminated Pushbuttons (Sub-Assembled)

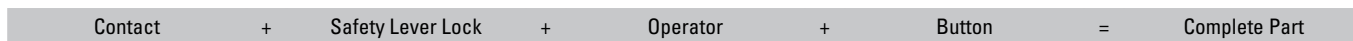

Operators



Style	Momentary	Maintained
Oversize Round 	HA1B-MO	HA1B-AO
Oversize Square 	HA2B-MO	HA2B-AO
Mushroom 	HA1B-MOL	HA1B-AOL

- In place of ① specify Button Color Code from table on right.
- In place of ② specify Lens Color Code from table on right.
- \*requires HA1L-MO or HA1L-AO operator instead of HA1B-MO or HA1B-AO.
- \*\*requires HA2L-MO or HA2L-AO instead of HA2B-MO or HA2B-AO.

Buttons/Lenses

Style	Button	Lens
Oversize Round Flush 	HA1A-B1-①	HA1A-L1-②*
Oversize Round Extended 	HA1A-B2-①	-
Oversize Square Flush 	HA2A-B1-①	HA2A-L1-②**
Oversize Square Extended 	HA2A-B2-①	-
Mushroom 	HA1A-B3-①	HA1A-L3-②

Contacts

Style	Contacts	Terminal Style	
		Solder Tab	PCB
	Gold SPDT DPDT	HA-C1	HA-C1V
		HA-C2	HA-C2V
	Silver SPDT DPDT	HA-C5	HA-C5V
		HA-C6	HA-C6V

Safety Lever Lock

Style	Part Number
	HA9Z-LS

① Button Color Code

Color	Code
Black	B
Green	G
Red	R
Blue	S
White	W
Yellow	Y

② Lens Color Code

Color	Code
Amber	A
Green	G
Red	R
Blue	S
Yellow	Y
White	W

### HA1B/HA1E Stop Switch

**Key features:**

- PCB or Solder Terminals
- Locking Lever Removable Contact Blocks
- Positive Action Contacts
- 1 or 2 form B (SPST-NC) Contacts
- IP65 Protection
- 16mm Mounting Hole
- Tamper Proof Construction



**Specifications**

Contact Form	1 or 2 form B (SPST-NC)	
Termination	PCB or Solder Terminal	
Contact Material	Silver	
Applicable Standards	EN60947-5-1, UL508, CSA 22.2. No. 14	
Rated Insulation Voltage	250V AC/DC	
Degree of Protection	IP65	
Conditional Short-Circuit Current and Short-Circuit Protective Device	50 A (at 250V) 10A 250V Fuse, operation class M according to IEC269-1 and IEC269-2	
Positive Opening Operation	Positive opening travel	3.4mm
	Minimum force required to achieve positive opening operation of all break contacts.	10.3 N (2 form B contacts)
	Maximum travel including travel beyond the minimum travel position	5.5mm
	Maximum frequency of actuation	1,200 operations/hour
Pollution Degree	3	

**Nameplates**

HAAV–Yellow Plastic

Marking	Part Number
Blank	HAAV-0

**Positive Action Stop Switch**

Style	Operation	Contact	Terminal Style	
			Solder Tab	PCB
Stop Switch	Pushlock/ Turn Reset	DPST(NC) (2 form B)	HA1B-V2E2R	HA1B-V2E2VR
		Short Body SPST-NC (1 form B) DPST-NC (2 form B)	HA1E-V2S1R HA1E-V2S2R	—

**Accessories: Shroud**

Style	Part Number	Applicable Standards
	XA9Z-KG1	SEMI S2 Compliant (Approved by TUV)

1. Button is non-removable, available in red and as complete assembled unit only.
2. Stop Switch does not come with safety lever lock.

**Buzzers (IP40)**

Style	Operating Voltage	Terminal Style	
		Solder/Tab	PCB
Buzzer-Rectangular	6V AC/DC ± 10%	LA3Z-1X2	LA3Z-1X2V
	12V to 24 AC/DC ± 10%	LA3Z-1X4	LA3Z-1X4V

**Buzzer Ratings**

Frequency	2 khz ± 500 HZ
Amplitude	80db @ 0.1m (at rated voltage)
Operating Voltage	6V AC/DC or 12 - 24V AC/DC ± 10%
Adjustable Cycle	55 to 600 cycles per minute
Current Draw	DC: 7mA AC: 20mA
Life	1000 hrs. minimum
Insulation Voltage	60V AC/DC
Operating Temperature	-20 to 55°C (no freezing), 45 to 85% RH
Degree of Protection	IP40

Pilot Lights (Assembled)

Pilot Lights

Style	Terminal Style	
	Solder Tab	PCB
Oversize Round 	HA1P-1C0③-②	HA1P-1C0③V-②
Oversize Square 	HA2P-1C0③-②	HA2P-1C0③V-②
Oversize Round Unibody 	HA1P-1③-②	—
Oversize Square Unibody 	HA2P-1③-②	—

② Lens/LED Color Codes

Color	Code
Amber	A
Green	G
Red	R
Blue	S
White	W
Yellow	Y

③ Voltage/Lamp Code

Voltage	Code
5V DC LED	1
6V AC/DC LED	2
12V AC/DC LED	3
24V AC/DC LED	4
120V AC LED	8
6V AC/DC Incandescent	5
12V AC/DC Incandescent	6
24V AC/DC Incandescent	7

- 1. In place of ② specify Lens/LED Color Code from table.
- 2. In place of ③ specify Voltage Code from table.

Pilot Lights (Sub-Assembled)

Terminals + Safety Lever Lock + Lamp Holder + Lamp + Operator + Lens = Completed Unit



Operators

Style	Part Number
Oversize Round	HA1P-0
Oversize Square	HA2P-0
Oversize Round Unibody	HA1P-00
Oversize Square Unibody	HA2P-00

Lenses

Style	Part Number
Oversize Round	HA1A-P1-②
Oversize Square	HA2A-P1-②

In place of ② specify lens color code.

Lamps

Style	Voltage	Part Number
LED	5V DC	LFTD-5②
	6V AC/DC	LFTD-6②
	12V AC/DC	LFTD-1②
	24V AC/DC	LFTD-2②
	120 V AC	LFTD-H2②
Incandescent	6V AC/DC	LH-06
	12V AC/DC	LH-14
	24V AC/DC	LH-28

In place of ② specify LED color code from table below.

Terminals

Style	Solder Tab	PCB
	HA-C00	HA-C00V

Not required for unibody operators.

Lamp Holder

Style	Part Number
	HA9Z-AH

Safety Lever Lock

Style	Part Number
	HA9Z-LS

② Lens/LED Color Codes

Color	Code
Amber	A
Green	G
Red	R
Blue	S
Yellow	Y
White	W

Illuminated Pushbuttons (Assembled)

Illuminated Pushbuttons

Style	Operation	Contact	Terminal Style	
			Solder Tab	PCB
Oversize Round 	Momentary	SPDT DPDT	HA1L-M1C5③-② HA1L-M1C6③-②	HA1L-M1C1③V-② HA1L-M1C2③V-②
	Maintained	SPDT DPDT	HA1L-A1C5③-② HA1L-A1C6③-②	HA1L-A1C1③V-② HA1L-A1C2③V-②
Oversize Square 	Momentary	SPDT DPDT	HA2L-M1C5③-② HA2L-M1C6③-②	HA2L-M1C1③V-② HA2L-M1C2③V-②
	Maintained	SPDT DPDT	HA2L-A1C5③-② HA2L-A1C6③-②	HA2L-A1C1③V-② HA2L-A1C2③V-②
Mushroom 	Momentary	SPDT DPDT	HA1L-M3C5③-② HA1L-M3C6③-②	HA1L-M3C1③V-② HA1L-M3C2③V-②
	Maintained	SPDT DPDT	HA1L-A3C5③-② HA1L-A3C6③-②	HA1L-A3C1③V-② HA1L-A3C2③V-②

- 1. In place of ② specify Lens Color Code from table.
- 2. In place of ③ specify Voltage Code from table.
- 3. PCB terminal models also available with silver contacts change "1" or "2" to "5" or "6" respectively, (ie LA1L-M1C14V-① becomes LA1L-M1C54V-①).
- 4. Light independent of switch position.

② Lens Color Codes

Color	Code
Amber	A
Green	G
Red	R
Blue	S
Yellow	Y
White	W

③ Voltage/Lamp Code

Voltage	Code
5V DC LED	1
6V AC/DC LED	2
12V AC/DC LED	3
24V AC/DC LED	4
120 V AC LED	8
6V AC/DC Incandescent	5
12V AC/DC Incandescent	6
24V AC/DC Incandescent	7



**Illuminated Pushbuttons (Sub-Assembled)**

Terminals + Safety Lever Lock + Lamp Holder + Lamp + Operator + Lens = Completed Unit



**Operators**



Style	Momentary	Maintained
 Oversize Round	HA1L-MO	HA1L-AO
 Oversize Square	HA2L-MO	HA2L-AO
 Mushroom	HA1B-MOL	HA1B-AOL

**Lenses**



Style	Part Number
 Oversize Round	HA1A-L1-Ⓜ
 Oversize Square	HA2A-L1-Ⓜ
 Mushroom	HA1A-L3-Ⓜ

 In place of Ⓜ specify lens color code.

**Lamps**

Style	Voltage	Part Number
 LED	5V DC	LFTD-5Ⓜ
	6V AC/DC	LFTD-6Ⓜ
	12V AC/DC	LFTD-1Ⓜ
	24V AC/DC	LFTD-2Ⓜ
	120 V AC	LFTD-H2Ⓜ
 Incandescent	6V AC/DC	LH-06
	12V AC/DC	LH-14
	24V AC/DC	LH-28

**Contacts**

Style	Contacts	Terminal Style	
		Solder Tab	PCB
 Gold	SPDT DPDT	HA-C10	HA-C10V
		HA-C20	HA-C20V
 Silver	SPDT DPDT	HA-C50	HA-C50V
		HA-C60	HA-C60V

**Lamp Holder**

Style	Part Number
	HA9Z-AH

**Safety Lever Lock**

Style	Part Number
	HA9Z-LS

Ⓜ **Lens/LED Color Codes**

Color	Code
Amber	A
Green	G
Red	R
Blue	S
Yellow	Y
White	W



**Selector Switches (Assembled)**

**Selector Switches**

Style	Position	Contact	Terminal Style		
			Solder Tab	PCB	
Oversize Round	90° 2-Position	Maintained	DPDT	HA1S-2C6	HA1S-2C2V
		Spring return from right	DPDT	HA1S-21C6	HA1S-21C2V
	45° 3-Position	Maintained	DPDT	HA1S-3C6	HA1S-3C2V
		Spring return from right	DPDT	HA1S-31C6	HA1S-31C2V
		Spring return from left	DPDT	HA1S-32C6	HA1S-32C2V
		2-Way spring return	DPDT	HA1S-33C6	HA1S-33C2V

**Contact Operations**

(for all selectors)

Contacts	Operator Position and Contact Operation	
2-pos. (DPDT)	Left	
	Right	
3-pos. (DPDT)	Left	
	Center	
	Right	

1. All assembled selector switches use DPDT contacts.
2. For SPDT contacts see sub-components on next page.
3. PCB terminal models also available with silver contacts change "1" or "2" to "5" or "6" respectively, (ie LA1S-21C2V becomes LA1S-21C6V).

As viewed from front of switch.

**Selector Switches (Sub-Assembled)**

Contact + Safety Lever Lock + Operator = Complete Part



**Operators**

Style	Position	Function	Part Number
Oversize Round	2	Maintained Spring from right	HA1S-2Y HA1S-21Y
	3	Maintained Spring from right Spring from left Spring from both	HA1S-3Y HA1S-31Y HA1S-32Y HA1S-33Y

**Safety Lever Lock**

Style	Part Number
	HA9Z-LS







**Contacts**

Style	Contacts	Terminal Style	
		Solder Tab	PCB
	SPDT	HA-C1	HA-C1V
	DPDT	HA-C2	HA-C2V
	SPDT	HA-C5	HA-C5V
	DPDT	HA-C6	HA-C6V

1. All assembled switches listed on previous page use DPDT contacts.
2. SPDT Contacts for use on 2 position selector switch only

## Key Switches (Assembled)

### Key Switches

Style	Position	Contact	Terminal Style		
			Solder Tab	PCB	
Oversize Round 	90° 2-Position	Maintained 	DPDT	HA1K-2C6 <sup>③</sup>	HA1K-2C2V <sup>③</sup>
		Spring return from right 	DPDT	HA1K-21C6B	HA1K-21C2VB
	45° 3-Position	Maintained 	DPDT	HA1K-3C6 <sup>③</sup>	HA1K-3C2V <sup>③</sup>
		Spring return from right 	DPDT	HA1K-31C6 <sup>③</sup>	HA1K-31C2V <sup>③</sup>
		Spring return from left 	DPDT	HA1K-32C6 <sup>③</sup>	HA1K-32C2V <sup>③</sup>
		2-Way spring return 	DPDT	HA1K-33C6D	HA1K-33C2VD

- 1. In place of <sup>③</sup> specify Key Retention Code from next page.
- 2. All assembled key switches have DPDT contacts. For SPDT see sub-assembled on next page.
- 3. PCB terminal models also available with silver contacts change "1" or "2" to "5" or "6" respectively, (ie LA1K-2C2V<sup>③</sup> becomes LA1K-2C6V<sup>③</sup>).

### Contact Operations

(for all selectors)

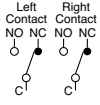
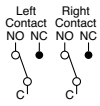
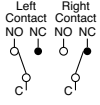
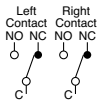
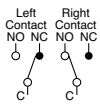
Contacts	Operator Position and Contact Operation	
2-pos. (DPDT)	Left	
	Right	
3-pos. (DPDT)	Left	
	Center	
	Right	

 As viewed from front of switch.

### ③ Key Retention Option Codes

Code	Description
A	Key not retained in any position (removable in all positions)
B	Key retained in right position only
C	Key retained in left position only
D	Key retained in left and right (3 position only)
E	Key retained in center only (3 position only)
G	Key retained right and center (3 position only)
H	Key retained left and center (3 position only)

 Key cannot be removed from a spring-return position.

**Selector Switches (Sub-Assembled)**

Contact + Safety Lever Lock + Operator = Complete Part





**Operators**

Style	Position	Function	Part Number
Oversize Round 	2	Maintained Spring from right	HA1K-2ⓐ HA1K-21B
	3	Maintained Spring from right Spring from left Spring from both	HA1K-3ⓐ HA1K-31ⓐ HA1K-32ⓐ HA1K-33D

- 1. In place of ⓐ specify key removable code from table on right.
- 2. Operator includes two keys.

**Contacts**

Style	Contacts	Terminal Style	
		Solder Tab	PCB
	SPDT DPDT	HA-C1	HA-C1V
		HA-C2	HA-C2V
	SPDT DPDT	HA-C5	HA-C5V
		HA-C6	HA-C6V

- 1. All assembled switches listed on previous page use DPDT contacts.
- 2. SPDT Contacts for use on 2 position selector switch only

**Safety Lever Lock**

Style	Part Number
	HA9Z-LS



**ⓐ Key Retention Option Codes**

Code	Description
A	Key not retained in any position (removable in all positions)
B	Key retained in right position only
C	Key retained in left position only
D	Key retained in left and right (3 position only)
E	Key retained in center only (3 position only)
G	Key retained right and center (3 position only)
H	Key retained left and center (3 position only)

- Key cannot be removed from a spring-return position.

Illuminated Selector Switches (Assembled)

Illuminated Selector Switches

Style	Position	Contact	Terminal Style		
			Solder Tab	PCB	
Round 	90° 2-Position	Maintained 	DPDT	LA1F-2C6③-②	LA1F-2C2③V-②
		Spring return from right 	DPDT	LA1F-21C6③-②	LA1F-21C2③V-②
	45° 3-Position	Maintained 	DPDT	LA1F-3C6③-②	LA1F-3C2③V-②
		Spring return from right 	DPDT	LA1F-31C6③-②	LA1F-31C2③V-②
		Spring return from left 	DPDT	LA1F-32C6③-②	LA1F-32C2③V-②
		2-Way spring return 	DPDT	LA1F-33C6③-②	LA1F-33C2③V-②
Square 	90° 2-Position	Maintained 	DPDT	LA2F-2C6③-②	LA2F-2C2③V-②
		Spring return from right 	DPDT	LA2F-21C6③-②	LA2F-21C2③V-②
	45° 3-Position	Maintained 	DPDT	LA2F-3C6③-②	LA2F-3C2③V-②
		Spring return from right 	DPDT	LA2F-31C6③-②	LA2F-31C2③V-②
		Spring return from left 	DPDT	LA2F-32C6③-②	LA2F-32C2③V-②
		2-Way spring return 	DPDT	LA2F-33C6③-②	LA2F-33C2③V-②
Rectangular 	90° 2-Position	Maintained 	DPDT	LA3F-2C6③-②	LA3F-2C2③V-②
		Spring return from right 	DPDT	LA3F-21C6③-②	LA3F-21C2③V-②
	45° 3-Position	Maintained 	DPDT	LA3F-3C6③-②	LA3F-3C2③V-②
		Spring return from right 	DPDT	LA3F-31C6③-②	LA3F-31C2③V-②
		Spring return from left 	DPDT	LA3F-32C6③-②	LA3F-32C2③V-②
		2-Way spring return 	DPDT	LA3F-33C6③-②	LA3F-33C2③V-②
Oversize Round 	90° 2-Position	Maintained 	DPDT	HA1F-2C6③-②	HA1F-2C2③V-②
		Spring return from right 	DPDT	HA1F-21C6③-②	HA1F-21C2③V-②
	45° 3-Position	Maintained 	DPDT	HA1F-3C6③-②	HA1F-3C2③V-②
		Spring return from right 	DPDT	HA1F-31C6③-②	HA1F-31C2③V-②
		Spring return from left 	DPDT	HA1F-32C6③-②	HA1F-32C2③V-②
		2-Way spring return 	DPDT	HA1F-33C6③-②	HA1F-33C2③V-②

Contact Operations

(for all selectors)

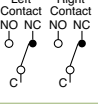
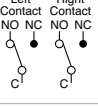
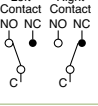
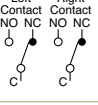
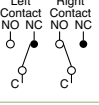
Contacts	Operator Position and Contact Operation	
2-pos. (DPDT)	Left	
	Right	
3-pos. (DPDT)	Left	
	Center	
	Right	



As viewed from front of switch.

② Lens/LED Color Codes

Color	Code	Color	Code
Amber	A	Blue	S
Green	G	Yellow	Y
Red	R	White	W

③ Voltage/Lamp Code

Voltage	Code
5V DC LED	1
6V AC/DC LED	2
12V AC/DC LED	3
24V AC/DC LED	4
120V AC LED	8
6V AC/DC Incandescent	5
12V AC/DC Incandescent	6
24V AC/DC Incandescent	7



- In place of ② specify Lens/LED Color Code from table above.
- In place of ③ specify Voltage Code from table above.
- All switches listed have DPDT contacts. For SPDT see sub-assembled on next page.
- PCB terminal models also available with silver contacts change "1" or "2" to "5" or "6" respectively, (ie LA1F-2C24V-② becomes LA1F-2C64V-②).
- Light independent of switch position.

**Illuminated Selector Switches (Sub-Assembled)**

Contacts + Safety Lever Lock + Lamp Holder + Lamp + Operator + Lens/Handle = Completed Unit



**Operators**

Style	Position	Function	Part Number
Round	2	Maintained Spring from right	LA1F-20 LA1F-210
	3	Maintained Spring from right	LA1F-30 LA1F-310
		Spring from left Spring from both	LA1F-320 LA1F-330
Square	2	Maintained Spring from right	LA2F-20 LA2F-210
	3	Maintained Spring from right	LA2F-30 LA2F-310
		Spring from left Spring from both	LA2F-320 LA2F-330
Rectangular	2	Maintained Spring from right	LA3F-20 LA3F-210
	3	Maintained Spring from right	LA3F-30 LA3F-310
		Spring from left Spring from both	LA3F-320 LA3F-330
Oversize Round	2	Maintained Spring from right	HA1F-20 HA1F-210
	3	Maintained Spring from right Spring from left Spring from both	HA1F-30 HA1F-310 HA1F-320 HA1F-330

**Safety Lever Lock**

Style	Part Number
	HA9Z-LS

**Lamp Holder**

Style	Part Number
	HA9Z-AH

**Lamps**

Style	Voltage	Part Number
LED	5V DC	LFTD-5Ⓢ
	6V AC/DC	LFTD-6Ⓢ
	12V AC/DC	LFTD-1Ⓢ
	24V AC/DC	LFTD-2Ⓢ
	120V AC	LFTD-H2Ⓢ
Incandescent	6V AC/DC	LH-06
	12V AC/DC	LH-14
	24V AC/DC	LH-28

In place of Ⓢ specify LED color code from table below.

**Contacts**

Style	Contacts	Terminal Style	
		Solder Tab	PCB
	SPDT	HA-C10	HA-C10V
	DPDT	HA-C20	HA-C20V
	SPDT	HA-C50	HA-C50V
	DPDT	HA-C60	HA-C60V

All assembled selectors on previous pages use DPDT contacts. SPDT contacts are for use only on two position selectors.

**Lenses/Handles**

Style	Part Number
Standard 	LA1A-F-Ⓢ
Oversize 	HA1A-F-Ⓢ

In place of Ⓢ specify lens color code from table.

**Ⓢ Lens/LED Color Codes**

Color	Code
Amber	A
Green	G
Red	R
Blue	S
Yellow	Y
White	W

### Pushbutton Selectors (Assembled)

#### Pushbutton Selectors

Style	Terminal Style	
	Solder Tab	PCB
	2 Position	HA1R-2C6-Ⓞ HA1R-2C2V-Ⓞ
	3 Position	HA1R-3C6-Ⓞ HA1R-3C2V-Ⓞ

- 1. In place of Ⓞ specify Button Color Code.
- 2. PCB terminal models also available with silver contacts (change "1" or "2" to "5" or "6" respectively, ie HA1R-2C2V-Ⓞ becomes HA1R-2C6V-Ⓞ).
- 3. Pushed position, momentary only.

#### ① Button Color Codes

Color	Code	Color	Code
Amber	A	Blue	S
Green	G	Yellow	Y
Red	R	White	W

#### Contact Operation









Style	Operator Position					
	Left		Center		Right	
	Normal	Pushed	Normal	Pushed	Normal	Pushed
2 Position			—	—		
3 Position				Blocked		

#### Contact Operation

Contacts	Operator Position and Contact Information	Operator Position and Contact Information		
		Down	Center	Up
2-pos. (DPDT)	Maintained Spring from Top			
2-pos. (DPDT)	Spring Return from Bottom			
3-pos. (DPDT)	All models			

 As viewed from front of switch.

#### Lever Switches

Style	Operation	Contacts	Terminal Type	
			Solder Tab	PCB
	Maintained 	DPDT	LA1T-2C6	LA1T-2C2V
	Spring return from top 	DPDT	LA1T-21C6	LA1T-21C2V
	Spring return from bottom 	DPDT	LA1T-22C6	LA1T-22C2V
3-Position	Maintained 	DPDT	LA1T-3C6	LA1T-3C2V
	Spring return from top 	DPDT	LA1T-31C6	LA1T-31C2V
	Spring return from bottom 	DPDT	LA1T-32C6	LA1T-32C2V
	Spring return from both 	DPDT	LA1T-33C6	LA1T-33C2V

- 1. PCB terminal models also available with silver contacts (change "1" or "2" to "5" or "6" respectively, ie LA1T-2C2V becomes LA1T-2C6V).
- 2. Terminology: U = up, D = down, C = center.

### Switch Engraving Order Form – L6 Series

Copy this order form and use it to specify Letter Height, Maximum Number of Lines and Text to be engraved.

To insure engraving accuracy, fax it to your IDEC representative or Distributor.

Your Company: \_\_\_\_\_  
 Name: \_\_\_\_\_  
 Address: \_\_\_\_\_  
 PO: \_\_\_\_\_

Telephone: \_\_\_\_\_  
 Fax: \_\_\_\_\_  
 Email: \_\_\_\_\_  
 Part Number to be Engraved: \_\_\_\_\_

Please check one of the boxes below to indicate your choice of engraving options:

**Rectangular  
Switch**

	# of Lines	Letter Height	Max. Characters Per Line
<input type="checkbox"/>	1	5/32	6
<input type="checkbox"/>	2	5/32	6
<input type="checkbox"/>		1/8	6
<input type="checkbox"/>	3	1/8	6
<input type="checkbox"/>	4	N/A	

**Square  
Switch**

	# of Lines	Letter Height	Max. Characters Per Line
<input type="checkbox"/>	1	5/32	5
<input type="checkbox"/>	2	5/32	5
<input type="checkbox"/>		1/8	6
<input type="checkbox"/>	3	1/8	6
<input type="checkbox"/>	4	N/A	

**Round  
Switch**

	# of Lines	Letter Height	Max. Characters Per Line
<input type="checkbox"/>	1	5/32	3
<input type="checkbox"/>		1/8	3
<input type="checkbox"/>	2	Custom*	
<input type="checkbox"/>	3	Custom*	
<input type="checkbox"/>	4	N/A	

\*Engraving is possible, but character size will be smaller than standard sizes.



- Above mentioned specifications hold true for standard size pushbuttons (round, square and rectangular).
- Oversize pushbuttons and pilot lights allow you to engrave 1 additional character.
- Engraving is done on the button itself for non-illuminated push buttons and on marking plate for illuminated pushbuttons and pilot lights.
- Please enter text exactly how you want it engraved, take care to emphasize capital or small letters.

Enter text to be engraved:

Line 1: \_\_\_\_\_  
 Line 2: \_\_\_\_\_  
 Line 3: \_\_\_\_\_  
 Line 4: \_\_\_\_\_

#### Sample Letter Sizes

1/8 Letters: **OPEN**

5/32 Letters: **OPEN**

For IDEC Internal Use Only:

Work Order #: \_\_\_\_\_



Switches & Pilot Devices

Signaling Lights

Relays & Sockets

Timers

Contactors

Terminal Blocks

Circuit Breakers

Accessories

Item	Appearance	Specifications	Part Number	Notes	
Ring Wrench		Made of metal	MT-001	Used for tightening the plastic locking ring when installing the L6 series unit on a panel. Tightening torque should not exceed 9kgf cm when tightening the locking ring.	
Lamp Holder Tool (Made of Rubber)		Made of rubber. Used for removing and replacing LED and incandescent lamps in illuminated units.	OR-44	Rubber tool used for replacing LED and incandescent lamps.	
Lens Removal Tool		For illuminated pushbuttons and pilot lights.	MT-101	Used for removing the lens or button from the housing.	
LED Lamp		5V DC 6V AC/DC 12V AC/DC 24V AC/DC 120V AC	LFTD-5Ⓢ LFTD-6Ⓢ LFTD-1Ⓢ LFTD-2Ⓢ LFTD-H2Ⓢ	T 1-3/4 miniature flange base. In place of Ⓢ specify LED Color Code (A, G, R, S, W, Y).	
Incandescent Lamp		6V AC/DC 12V AC/DC 24V AC/DC	LH-06 LH-14 LH-28	0.5W, T 1-3/4 miniature flange base	
Switch Guard		180 degrees opening, spring return	HA9Z-K1	Prevents inadvertent switch operation. IP65 oiltight rated.	
Terminal Cover		Made of white nylon	All removable contacts	H6-VL2	Covers terminals to prevent possible electric shock.
			Unibody Pilot Lights	H6-PVL	
Mounting Hole Plug		Rubber	AL-B6	Fills unused panel cutouts. Made of nitrile rubber. Push-in installation from front of panel. IP65 (oiltight) rated.	
		Aluminum	AL-BM6	Fills unused panel cutouts. Made of aluminum. Screw-on locking ring from inside of panel. IP65 (oiltight) rated.	
Replacement Keys		for HA1K (#231) – oversize	KG9Z-SK	Pair of keys.	
Replacement Engraving Inserts			Oversize Round Oversize Square Mushroom	HA9Z-P1-W HA9Z-P2-W HA9Z-P13-W	
Replacement Locking Ring		All models		HA9Z-LN	
Replacement Anti-Rotation Ring			L6 oversize	HA9Z-LP	Prevents rotation of switches in panel. (included with all assembled switches)
Replacement Selector Inserts				HA9Z-HC1-Ⓢ	Applicable to round oversize selectors only Ⓢ = (G, R, S, W, Y)
Replacement Safety Lever Lock				HA9Z-LS	



Item	Appearance	Description	Used With	Part Number
Flush Bezel		ø24mm round, metal (aluminum color), panel cut-out ø20.2mm	Illuminated selector switches.	LA9Z-SM61
		ø24mm round, plastic (black), panel cut-out ø20.2mm	L6 Switch	LA9Z-S61B
		□24mm square, plastic (black), panel cut-out □20.2mm	+	LA9Z-S71B
		24 x 30mm rectangular, plastic (black), panel cut-out ø20.2 x 26.2mm	=	LA9Z-S81B
Switch Guard w/ Flush Bezel (spring return)		Rectangular, plastic (black)	Flush Switch	LA9Z-KS8

Flush bezels not applicable for oversize units.

### Dimensions (mm)

#### Lever Switches (LA1T)

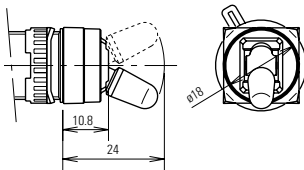

#### Buzzer (LA3Z)

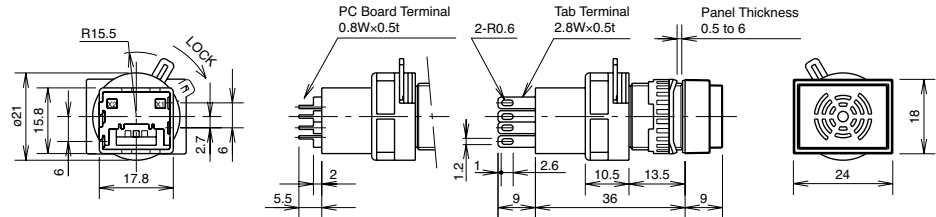

#### Emergency Stop Switch (HA1B)

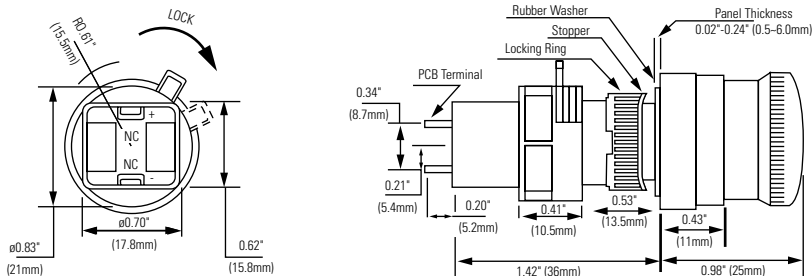

#### Emergency Stop Switch (HA1E) - Short Body Style

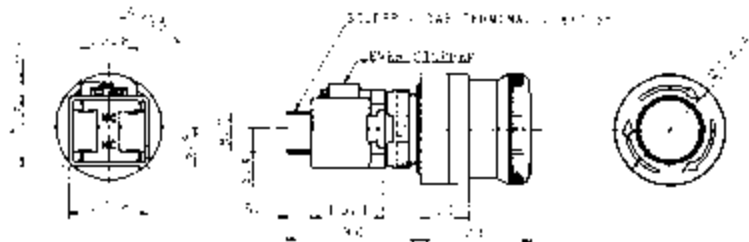

Switches & Pilot Devices

Signaling Lights

Relays & Sockets

Timers

Contactors

Terminal Blocks

Circuit Breakers

Illuminated Selector Switches (LA\*F)

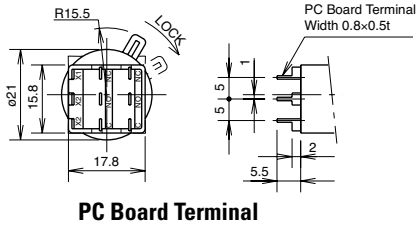
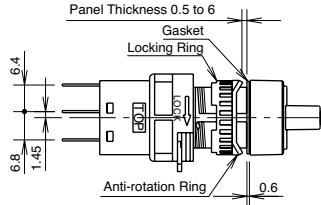

PC Board Terminal

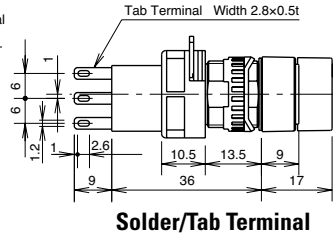

Solder/Tab Terminal

Round

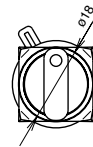

Square



Rectangular

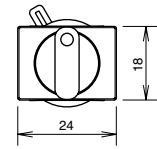

PC Board Drilling Layout (Bottom View)

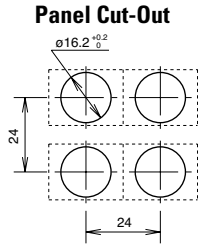

Illuminated Pushbuttons, Illuminated Selector Switches

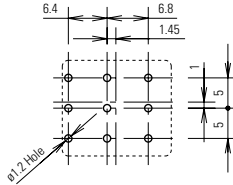

Pilot Lights, Selector Switches, Key Selector Switches

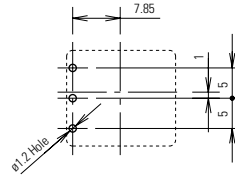

Pushbutton Lever Switches

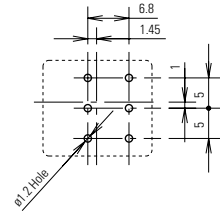

HA1B E-Stop

PCB Mounting Pattern

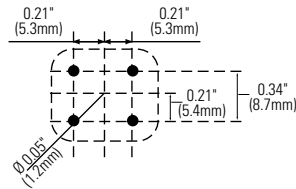

OverSize Flush Pushbutton and Pilot Lights

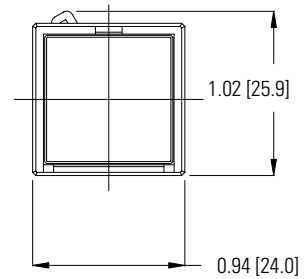
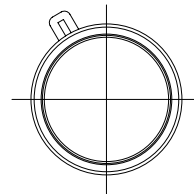
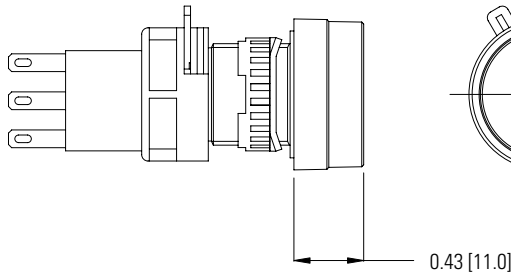
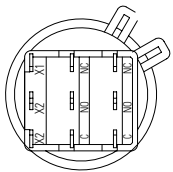

**Oversize Extended Non-Illuminated Pushbutton**

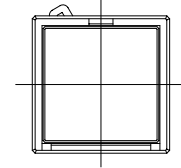
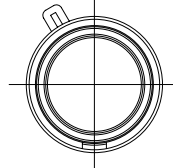
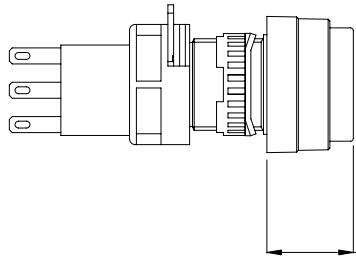
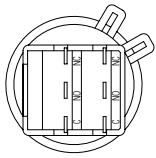

0.59 [15.1]

**Oversize Unibody Pilot Lights**

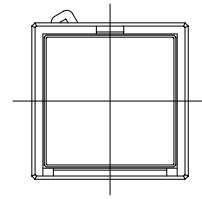
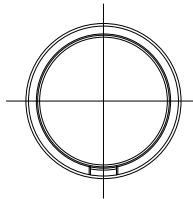
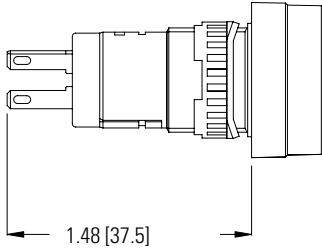
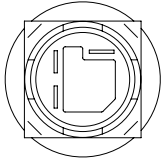

1.48 [37.5]

**Mushroom Pushbuttons**

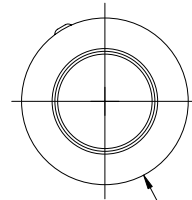
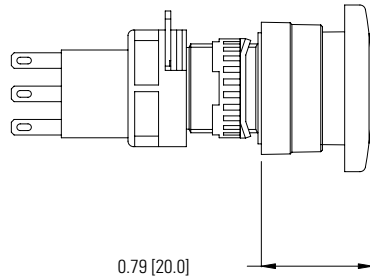
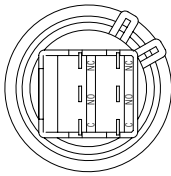

1.18 [30.0]

0.79 [20.0]

**Oversize Selector Switch**

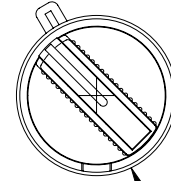
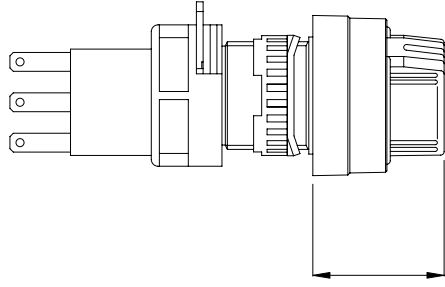
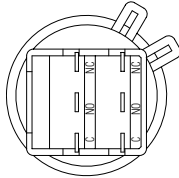

0.94 [23.8]

0.77 [19.5]

Switches & Pilot Devices

**Oversize Key Switch**

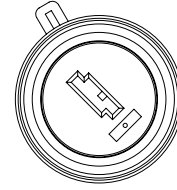
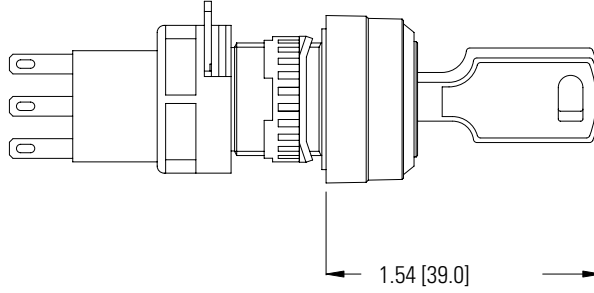
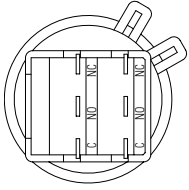

Signaling Lights

**Lever Switch**

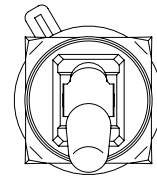
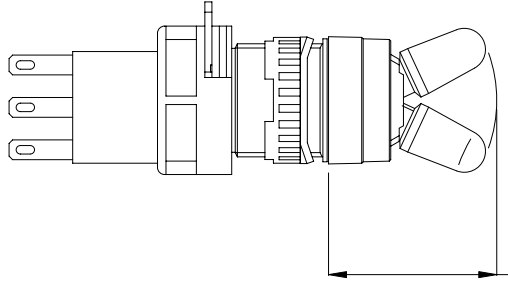
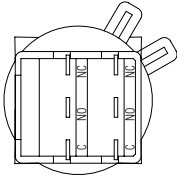

Relays & Sockets

**Flush Bezel**

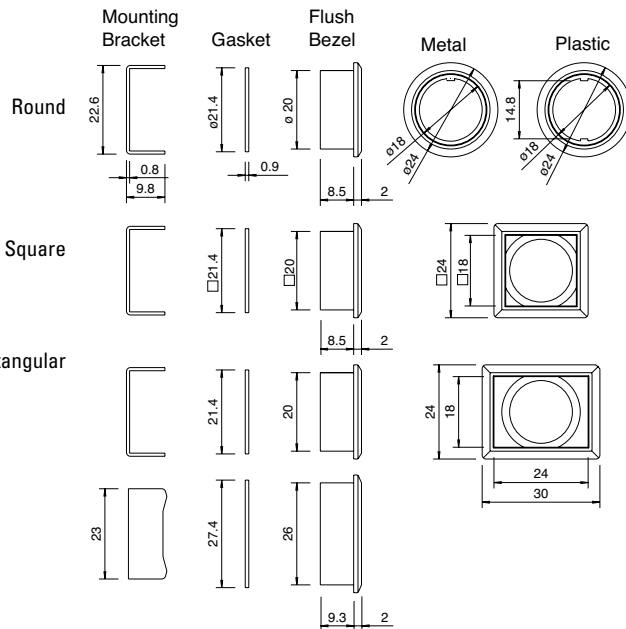

**Selector Switches**

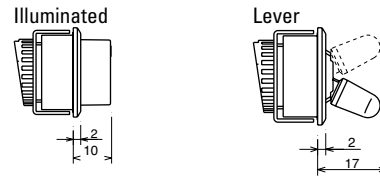

Timers

Contactors

Terminal Blocks

Circuit Breakers

**Flush Bezel Mounting Hole Layout**

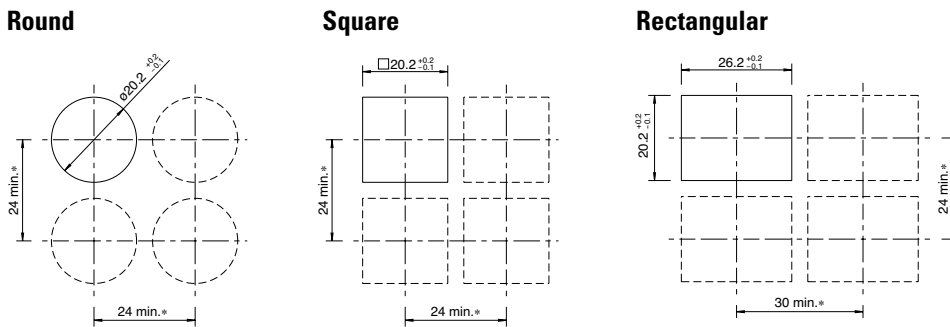

Terminal Configurations

Non Illuminated Pushbutton

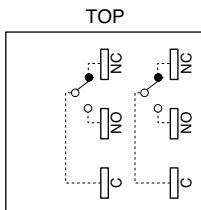

Pilot Lights

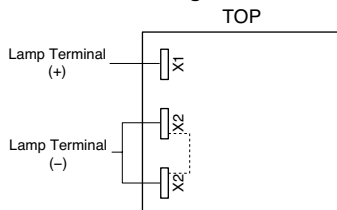

AL-K6SP

Illuminated Pushbuttons

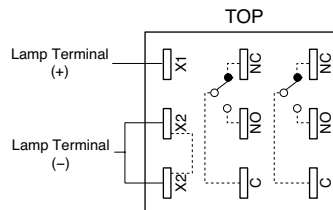

Buzzer

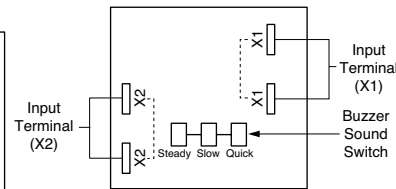

H6-VL2

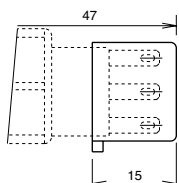

AL-B6

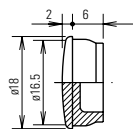

AL-BM6

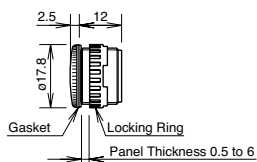

LFTD

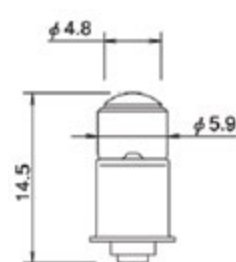

LED Lamp Internal Circuit

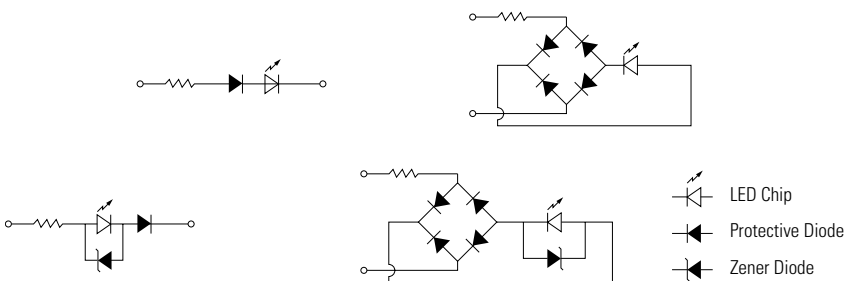

AL-B6

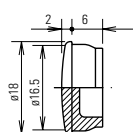

Switches & Pilot Devices

Signaling Lights

Relays & Sockets

Timers

Contactors

Terminal Blocks

Circuit Breakers

**General Instructions**

**Pushbutton Assembly  
Lamp Installation**

Lamps can be replaced in two ways:

1. If contacts are accessible (or pushbutton not installed in a panel) then it is easiest to first remove the contacts from the operator. This will allow easy access to the lamp/lamp-holder assembly. Grab lamp, depress slightly, and turn counter clockwise. Lamp can then be removed by pushing it back through the lamp holder.
2. If contacts are not accessible, then the lamp can be replaced by first removing the lens from the operator. Just pull lens straight out either with a fingernail or optional lens removal tool (MT-101). Lamp/lamp-holder assembly can then be removed with lamp removal tool (OR-44). Insert lamp removal tool through operator, depress slightly, turn counter clockwise, then pull lamp/lamp-holder assembly out. Lamp can then be removed by pushing it back through the lamp holder.

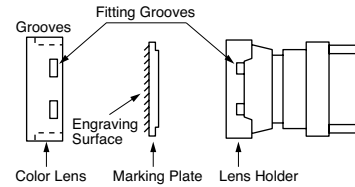
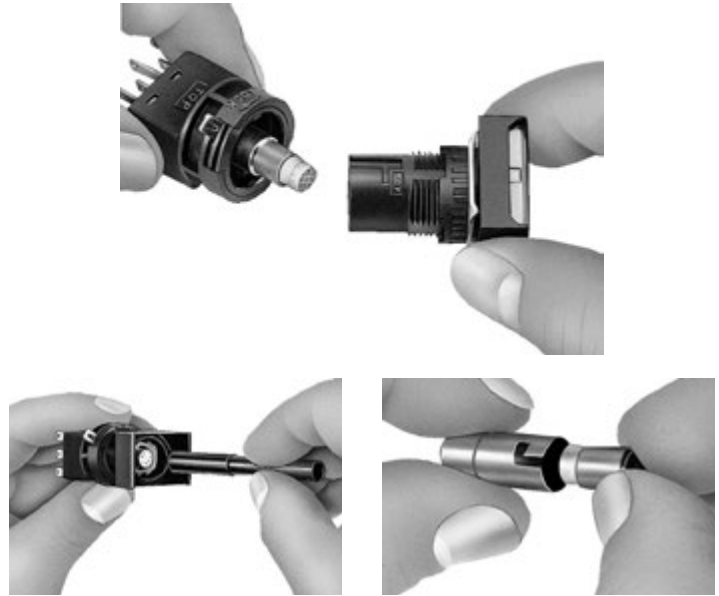

**Engraving Lenses**

All buttons and lenses can be engraved directly on the outside surface. Illuminated lenses also allow for engraving on a plate that is underneath the colored section of the lens. Remove the colored section of the lens by pulling on the edge while simultaneously unhooking it from the latches on the lens holder. The marking plate will then be accessible. It can then be engraved or a thin marked insert (such as mylar or paper) can be sandwiched between the marking plate and colored section of the lens.

**Panel Mounting**

Before any unit can be mounted into a panel, the contact block must be removed. Slide metal locking lever and pull contact off. Loosen and remove the locking ring and square anti-rotation ring from the operator and insert operator through panel cutout from the front of the panel. Slide on anti-rotation ring and tighten locking ring, using locking ring wrench (MT-001). Slide contact block onto operator, observing TOP marking on both parts. Slide metal locking lever in direction indicated by LOCK. The yellow plastic safety lever lock can then be snapped onto the locking lever; this will prevent vibration or maintenance actions from releasing the contact from the operator.

**PCB Mounting**

Being able to separate the contacts from the operator allows for assembly of the front panel components (operator and lens) to be performed in tandem with the PC board assembly and soldering. For applications where multiple rows of push-buttons are mounted closely together, or where other components may obstruct access to the contact locking lever, be sure to include access holes in the PC board (refer to PC board layout dimensions for location). Also be sure to allow for space above and to the side of contact to ensure that no components block the contact block locking lever. PC board pins are designed to rest on the PCB, take this into consideration to ensure that pins do not short closely spaced traces.

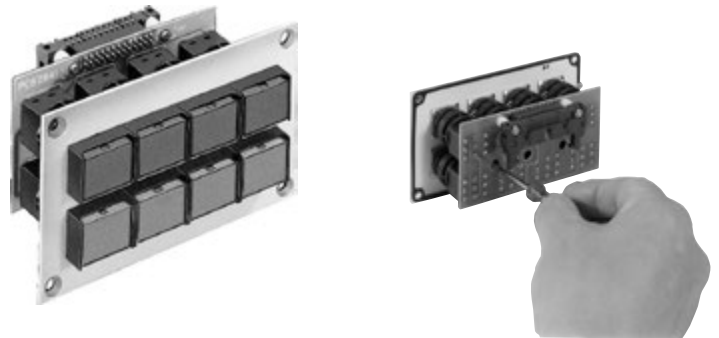

## 22mm XW E-Stops

## Key features:

- The depth behind the panel can be as little as 46.4 mm for 1 to 4 contacts (with terminal cover) for illuminated and non-illuminated units.
- IDEC's original "Safe break action" ensures that the NC contacts open when the contact block is detached from the operator.
- 1 to 4NC main contacts and 1 or 2NO monitor contacts
- Push-to-lock, Pull or Turn-to-reset operator
- Models with mechanical indicator on the operator body show the normal/latched status (green: normal).
- Safety lock mechanism (IEC60947-5-5, 6.2)
- Degree of protection IP65 (IEC60529)
- Fingersafe (IP20) terminals
- Three button sizes: ø38, ø40 and ø60 mm
- Push-ON illumination type available (40mm mushroom head)
- Direct opening action mechanism (IEC60947-5-5, 5.2, IEC60947-5-1, Annex K)
- RoHS compliant (EU directive 2002/95/EC).
- UL c-UL listed. EN compliant
- UL NISD category emergency stop device (File# E305148)



UL File #E68961



CCC No. 2005010305150897





## Specifications



Applicable Standards	IEC60947-5-5, EN60947-5-5, JIS C8201-5-1, UL508, UL991, NFPA79, CSA C22.2 No. 14, GB14048.5
Operating Temperature	Non-illuminated: -25 to +60°C (no freezing), Illuminated: -25 to +55°C (no freezing)
Operating Humidity	45 to 85% RH (no condensation)
Storage Temperature	-45 to +80°C
Operating Force	Push-to-lock: 32N Pull-to-reset: 21N Turn-to-reset: 0.27N·m
Minimum Force Required for Direct Opening Action	80N
Min Operator Stroke Required for Direct Opening Action	4mm
Maximum Operator Stroke	4.5mm
Contact Resistance	50mΩ maximum (initial value)
Contact Material	Gold plated silver
Insulation Resistance	100MΩ minimum (500V DC megger)
Impulse Withstand Voltage	2.5kV
Pollution Degree	3
Operation Frequency	900 operations/hour
Shock Resistance	Operating extremes: 150m/s <sup>2</sup> (15G), Damage limits: 1000m/s <sup>2</sup> (100G)
Vibration Resistance	Operating extremes: 10 to 500Hz, amplitude 0.35mm acceleration 50m/s <sup>2</sup> Damage limits: 10 to 500Hz, amplitude 0.35mm acceleration 50m/s <sup>2</sup>
Mechanical Life	250,000 operations minimum
Electrical Life	100,000 operations minimum, (250,000 operations minimum @ 24V AC/DC, 100mA)
Degree of Protection	Operator: IP65 (IEC60529) Terminal: IP20 (when XW9Z-VL2MF is installed)
Terminal Style	M3.0 screw terminal
Recommended Tightening Torque for Locking Ring	2.0N·m
Wire Size	16 AWG max
Weight	ø40mm: 72g ø60mm: 81g

Part Numbers

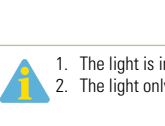
Standard Button Without Mechanical Indicator

Style	Operator Type	Monitor Contact	Main Contact	Part Number
Non-Illuminated 	40mm Mushroom	1NO	1NC	XW1E-BV411M-R
		-	2NC	XW1E-BV402M-R
		2NO	2NC	XW1E-BV422M-R
		1NO	3NC	XW1E-BV413M-R
Non-Illuminated 	60mm Mushroom	-	4NC	XW1E-BV404M-R
		1NO	1NC	XW1E-BV511M-R
		-	2NC	XW1E-BV502M-R
		2NO	2NC	XW1E-BV522M-R
Illuminated <sup>1</sup> 	40mm Mushroom with built-in 24V AC/DC LED	1NO	3NC	XW1E-BV513M-R
		-	4NC	XW1E-BV504M-R
		1NO	1NC	XW1E-LV411Q4M-R
		-	2NC	XW1E-LV402Q4M-R
Illuminated <sup>1</sup> 	40mm Mushroom Push-ON LED <sup>2</sup>	2NO	2NC	XW1E-LV422Q4M-R
		1NO	3NC	XW1E-LV413Q4M-R
		-	4NC	XW1E-LV404Q4M-R
		1NO	2NC	XW1E-TV412Q4M-R

Smooth Button With Mechanical Indicator

Style	Operator Type	Monitor Contact	Main Contact	Part Number
Non-Illuminated 	38mm Mushroom	-	1NC	XW1E-BV4TG01MR
		-	2NC	XW1E-BV4TG02MR
		-	3NC	XW1E-BV4TG03MR
		-	4NC	XW1E-BV4TG04MR
		1NO	1NC	XW1E-BV4TG11MR
		1NO	2NC	XW1E-BV4TG12MR
		1NO	3NC	XW1E-BV4TG13MR
Illuminated 	38mm Mushroom with built-in 24V AC/DC LED <sup>1</sup>	2NO	4NC	XW1E-BV4TG22MR
		-	1NC	XW1E-LV4TG01Q4MR
		-	2NC	XW1E-LV4TG02Q4MR
		-	3NC	XW1E-LV4TG03Q4MR
		-	4NC	XW1E-LV4TG04Q4MR
		1NO	1NC	XW1E-LV4TG11Q4MR
		1NO	2NC	XW1E-LV4TG12Q4MR
1NO	3NC	XW1E-LV4TG13Q4MR		
2NO	2NC	XW1E-LV4TG22Q4MR		



- 1. The light is independent of the position of the switch, except for push-on LED type.
- 2. The light only operates when the switch is pressed as it is internally wired.

- Note: Pushlock pull/turn reset switches are locked when pressed, and reset when pulled or turned clockwise.
- 1. LED lamp is not removable.

XW Series EMO Switches

Style	NC Main Contact	NO Monitor Contact	Part Number
40mm Mushroom 	1NC	-	XW1E-BV401M-RH-EMO
	2NC	-	XW1E-BV402M-RH-EMO
	3NC	-	XW1E-BV403M-RH-EMO
	4NC	-	XW1E-BV404M-RH-EMO
	1NC	1NO	XW1E-BV411M-RH-EMO
	2NC	1NO	XW1E-BV412M-RH-EMO
	3NC	1NO	XW1E-BV413M-RH-EMO
	2NC	2NO	XW1E-BV422M-RH-EMO

FB Enclosures with XW E-Stops

Style	Style	NC Contact	NO Contact	Part Number
	40mm Push-lock Turn/Pull Reset Non-Illuminated	2NC	-	FB1W-XW1E-BV402MR
		1NC	1NO	FB1W-XW1E-BV411MR
		2NC	2NO	FB1W-XW1E-BV422MR
		3NC	1NO	FB1W-XW1E-BV413MR
		4NC	-	FB1W-XW1E-BV404MR
	40mm Push-lock Turn/Pull Reset Illuminated*	2NC	-	FB1W-XW1E-LV402MR
		1NC	1NO	FB1W-XW1E-LV411MR
		2NC	2NO	FB1W-XW1E-LV422MR
		3NC	1NO	FB1W-XW1E-LV413MR
	60mm Push-lock Turn/Pull Reset Non-Illuminated	4NC	-	FB1W-XW1E-LV404MR
		2NC	-	FB1W-XW1E-BV502MR
		1NC	1NO	FB1W-XW1E-BV511MR
		2NC	2NO	FB1W-XW1E-BV522MR
		3NC	1NO	FB1W-XW1E-BV513MR
		4NC	-	FB1W-XW1E-BV504MR



For added safety, Switch Guards and Nameplates can be used with E-Stop Enclosures

- \*LED illumination voltage: 24V AC/DC



Contact Ratings

Rated Insulation Voltage (Ui)		250V				
Rated Current (Ith)		5A				
Rated Operating Voltage (Ue)		30V	125V	250V		
Rated Operating Current	Main Contacts (NC)	AC 50/60Hz	Resistive Load (AC-12)	–	5A	3A
			Inductive Load (AC-15)	–	3A	1.5A
	DC	Resistive Load (DC-12)	2A	0.4A	0.2A	
		Inductive Load (DC-13)	1A	0.22A	0.1A	
Rated Operating Current	Monitor Contacts (NO)	AC 50/60Hz	Resistive Load (AC-12)	–	1.2A	0.6A
			Inductive Load (AC-14)	–	0.6A	0.3A
	DC	Resistive Load (DC-12)	2A	0.4A	0.2A	
		Inductive Load (DC-13)	1A	0.22A	0.1A	

Mounting Hole Layout

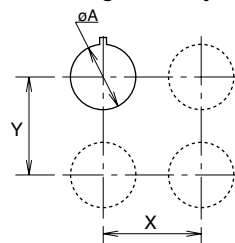

Measurements

Size	øA	X & Y
40mm	22.3 <sup>+0.4</sup>	70mm min

Panel Cutout

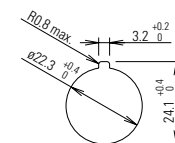

Minimum applicable load: 5V AC/DC, 1mA (reference value).  
The rated operating currents are measured at resistive/inductive load types specified in IEC 60947-5-1.

Illuminated Unit LED Ratings

Operating Voltage	Current
24V AC/DC ±10%	15mA

Depth Behind the Panel

Depth (mm)	Description
46.4	with indicator, 1 - 4 contacts, both illuminated and non-illuminated
48.7	w/o indicator, 1 - 4 contacts, both illuminated and non-illuminated

Part Number Key

**XW1E - L V 4 TG 11 Q4MR**

**Illumination**  
 B: Non-Illuminated  
 L: Illuminated LED  
 T: Illuminated Push-ON LED

**Indicator**  
 TG: w/green mechanical indicator  
 blank: w/o indicator

**Contact Configuration**  
 11: 1NO - 1NC  
 02: 2NC  
 13: 1NO - 3NC  
 04: 4NC  
 22: 2NO-2NC  
 12: 1NO-2NC (Push-ON LED only)  
 01: 1NC (EMO switch only)  
 03: 3NC (EMO switch only)

**Color**  
 R: red with indicator  
 -R: red w/o indicator  
 -RH-EMO: red w/o indicator with EMO engraving

**Mushroom Size**  
 4: ø40mm  
 5: ø60mm (non-illuminated only)

**Voltage Code**  
 Blank: Non-illuminated  
 Q4: Illuminated 24V AC/DC

Terminal Arrangements (Bottom View)

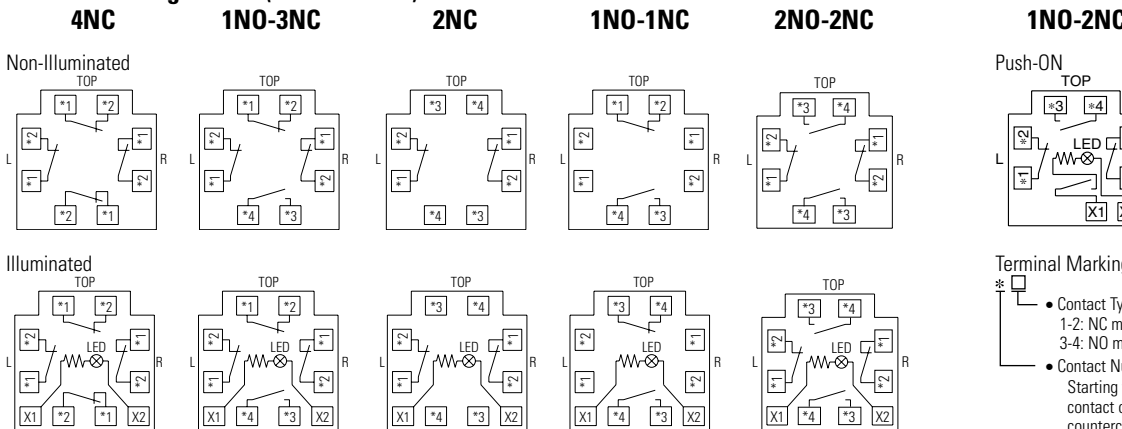

Terminal Marking Description

- Contact Type  
 1-2: NC main contact  
 3-4: NO monitor contact
- Contact Number (1-4)  
 Starting with the contact on TOP in a counterclockwise direction.  
 Note:  
 1: contact on the TOP  
 2: contact on the Left  
 3: contact on the Bottom  
 4: contact on the Right

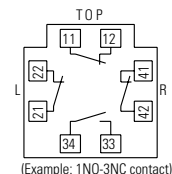

Dimensions (mm)

**XW Standard Button Non-Illuminated Without Indicator (with terminal cover)**

**XW Standard Button LED Illuminated/ Push-ON Without Indicator (with terminal cover)**

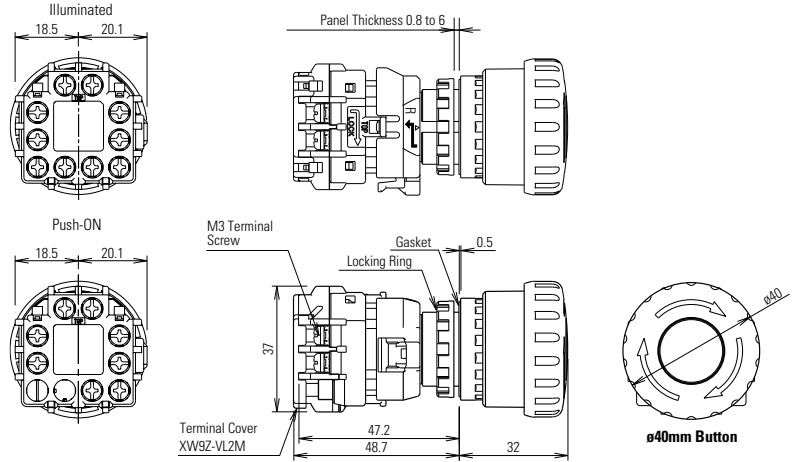
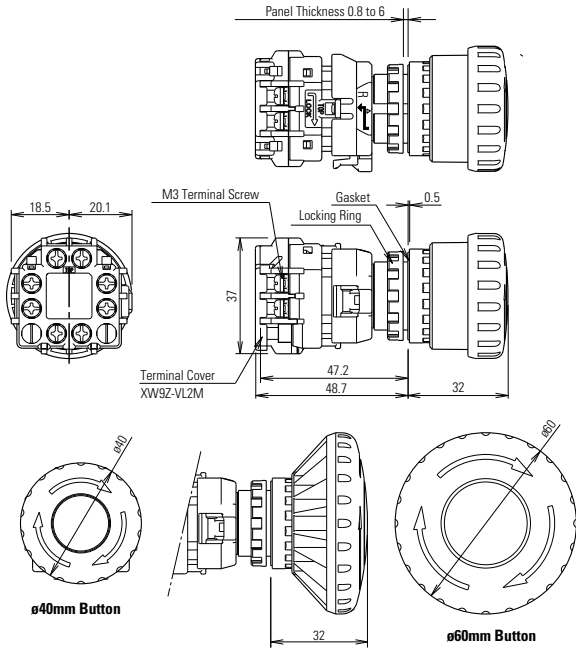

**XW Smooth Button Non-Illuminated With Indicator (with terminal cover)**

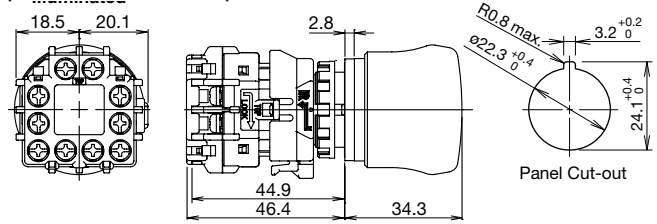
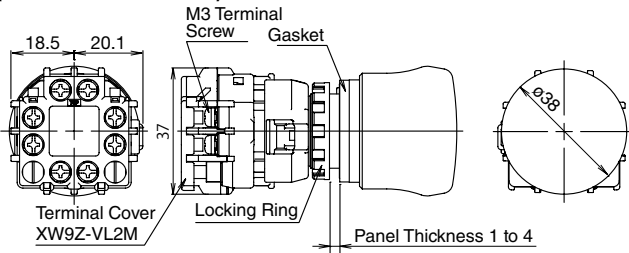

**XW Smooth Button LED Illuminated/ Push-ON With Indicator (with terminal cover)**

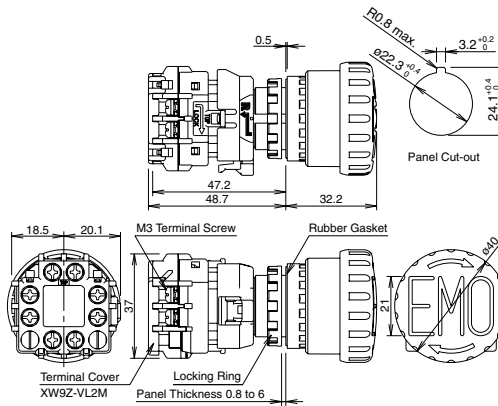
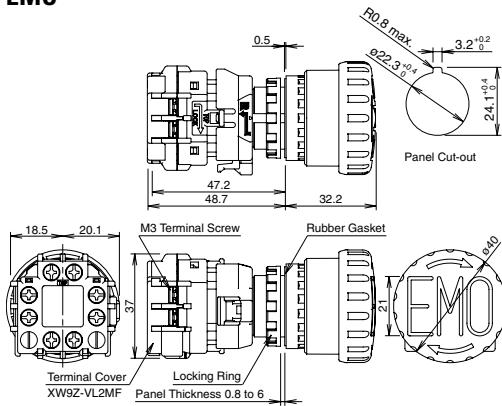

**EMO**



**Accessories: Terminal Covers**





Appearance	Description	Part Numbers
	Terminal Cover for contact block	XW9Z-VL2M
	IP20 Fingersafe Cover	XW9Z-VL2MF

**Accessories: Nameplates**

Appearance	Legend	Part Number	Inner Ø	Outer Ø
	(blank)	HWAV-0	22mm	60mm
	"Emergency Stop"	HWAV-27	22mm	60mm
	(blank)	HWAV5-0	22mm	80mm
	"Emergency Stop"	HWAV5-27	22mm	80mm

 Use 60mm nameplates for 38mm and 40mm mushroom buttons and 80mm nameplates for 60mm mushroom buttons.

**Accessories: Shrouds**

Appearance	Part Numbers	E-Stop Types	Applicable Standards
	HW9Z-KG1	38mm, 40mm Mushroom Head	SEMI S2-0703, 12.5.1 Compliant
	HW9Z-KG2	38mm, 40mm, and 60mm Mushroom Head	SEMI S2-0703, 12.5.1 & SEMATECH Compliant
	HW9Z-KG3	38mm, 40mm Mushroom Head	SEMI S2 Compliant (Approved by TUV)
	HW9Z-KG4	38mm, 40mm Mushroom Head	SEMI S2 Compliant (Approved by TUV) & SEMATECH

**Operating Instructions**

**Removing the Contact Block**

First unlock the operator button. Grab the bayonet ring ① and pull back the bayonet ring until the latch pin clicks ②, then turn the contact block counterclockwise and pull out ③.

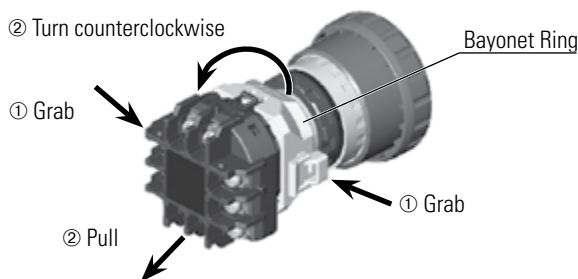

**Notes for removing the contact block**

1. When the contact block is removed, the monitor contact (NO contact) is closed.
2. While removing the contact block, do not exert excessive force, otherwise the switch may be damaged.
3. An LED lamp is built into the contact block for illuminated pushbuttons. When removing the contact block, pull the contact block straight to prevent damage to the LED lamp. If excessive force is exerted, the LED lamp may be damaged and fail to light.

**Panel Mounting**

Remove the locking ring from the operator and check that the rubber gasket is in place. Insert the operator from panel front into the panel hole. Face the side without thread on the operator with TOP marking upward, and tighten the locking ring using ring wrench MW9Z-T1 to a torque of 2.0 N·m maximum.

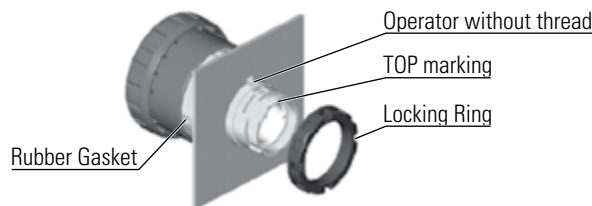

**Notes for Panel Mounting**

To prevent the XW emergency stop switch from rotating when resetting from the latched position, use of an anti-rotation ring (HW9Z-RL) or a nameplate is recommended.

**Installing the Contact Block**

First unlock the operator button. Align the small ▲ marking on the edge of the operator with the small ▼ marking on the yellow bayonet ring. Hold the contact block, not the bayonet ring. Press the contact block onto the operator and turn the contact block clockwise until the bayonet ring clicks.

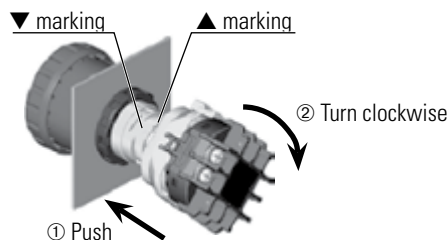

**Notes for installing the contact block**

Make sure that the bayonet ring is in the locked position. Check that the two projections on the bayonet ring are securely in place.

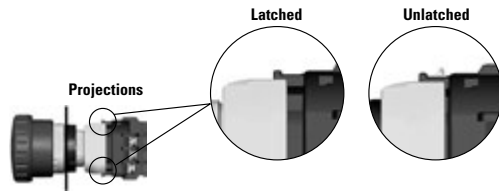

**Wiring**

The applicable wire size is 16 AWG maximum.

**Screw Terminal**

1. Wire thickness: AWG18 to 16
2. Tighten the M3 terminal screw to a tightening torque of 0.6 to 1.0 N·m.

**Installing and Removing Terminal Covers**

**XW9Z-VL2M**

To install the terminal cover, align the TOP marking on the terminal cover with the TOP marking on the contact block. Place the two projections on the bottom side of the contact block into the slots in the terminal cover. Press the terminal cover toward the contact block.

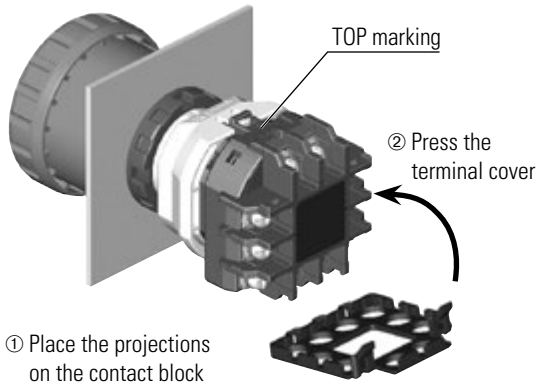

To remove the terminal cover, pull out the two latches on the top side of the terminal cover. Do not exert excessive force to the latches, otherwise the latches may break.

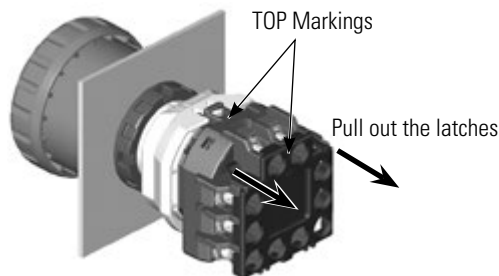

**IP20 Protection Terminal Cover XW9Z-VL2MF**

To install the IP20 protection cover, align the TOP marking on the cover with the TOP marking on the contact block, and press the cover toward the contact block.

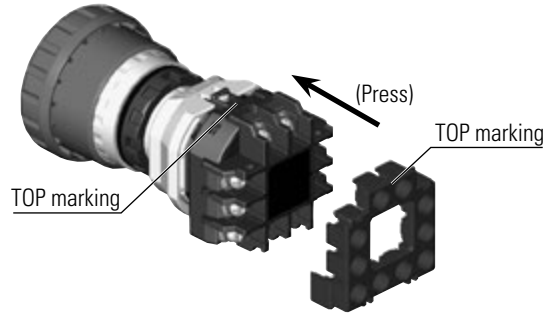

1. Once installed, the XW9Z-VL2MF cannot be removed.
2. The XW9Z-VL2MF cannot be installed after wiring.
3. With the XW9Z-VL2MF installed, crimping terminals cannot be used.
4. Make sure that the XW9Z-VL2MF is securely installed. IP20 protection cannot be achieved when installed loosely, and electric shocks may occur.

**Contact Bounce**

When the button is reset by pulling or turning, the NC main contacts will bounce. When pressing the button, the NO monitor contacts will bounce.

When designing a control circuit, take the contact bounce time into consideration (reference value: 20 ms).

**LED Illuminated Switches**

LED lamp is built into the contact block and cannot be replaced.

**Installing the Anti-rotation Ring HW9Z-RL**

Align the side without thread on the operator with TOP marking, the small marking on the anti-rotation ring, and the recess on the mounting panel.

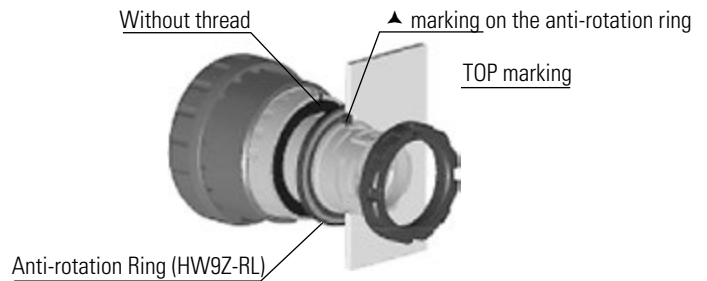

### AP22M Series



#### Key Features

- Viewable in direct sunlight.
- Visible from all directions.
- The use of an ultra-bright LED that is not susceptible to external scattered light ensures high visibility and provides for more accurate recognition.
- Integrated terminal cover is IP20 protected (finger protection), preventing electrical shocks.
- UL and c-UL listed, EN standard compliant.
- Colored and clear lenses are offered. Clear lens (except for PW) provides for higher contrast.
- UL Type 4X





#### Part Numbers

##### Pilot Lights

Appearance	Lens	Rated Voltage	Part Number	Lamp Color
	Color	12V DC 24V AC/DC 120V AC	AP22M-2Q4①	R G Y A S PW
	Clear		AP22M-2Q4C①	R G Y A S

1. In place of ① insert LED color. Red (R), Green (G), Yellow (Y), Amber (A), Blue (S), and White (PW).
2. Clear lenses are standard (except for white). White (PW) only available as colored lens.
3. In place of ② insert voltage code. For 12V DC use (3), for 24V AC/DC use (4), for 120V AC use (H).
4. LED cannot be removed or replaced.

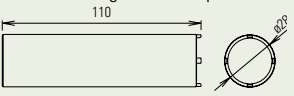
#### Accessories

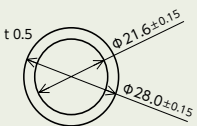
Appearance	Material	Part Number	Notes
	Metal (brass)	MW9Z-T1	Used for mounting unit into a panel. 
	Resin	YW9Z-PL12①	Dimension: ø29.8 H14.5 In place of ① insert color: R (Red), G (green), Y (Yellow), A (Amber), S (Blue), C (Clear*)
	Nitrile rubber	HW9Z-WM	

1. Nameplates: HWAM, HWAS-0, and CWAM. Go to [www.IDEC.com](http://www.IDEC.com) and review HW Series and CW Series catalogs for detailed information.
2. \*Use a clear lens (C) for a PW (White) lamp.

Specifications

Environment	Operating Temperature: -25 to +55°C (no freezing) Storage Temperature: -45 to +80°C (no freezing) Operating Humidity: 45-85%RH (no condensation)	
Insulation Resistance	100MΩ (DC500V megger)	
Over Voltage Category	II (IEC60664-1)	
Impulse Dielectric Strength	2.5kV (IEC60664-1, IEC60947-5-1)	
Degree of pollution	3 (IEC60947-5-1)	
Dielectric Strength	between terminals of different poles: 2,000V AC, 1 min between live and non-live parts: 2,000V AC, 1 min	
Vibration Resistance	Operation limit	5-55Hz half amp: 0.5mm
	Damage limit	30Hz half amp: 1.5mm
Shock Resistance	Operation limit	100m/s <sup>2</sup> (10G)
	Damage limit	1000m/s <sup>2</sup> (100G)
Degree of Protection	Panel front: IP66 (IEC 60529), UL Type 4X Terminals: IP20	
Terminal Size	M3.5 screw	
Tightening torque for terminal screw	1.0N•m	
Tighten'g torque for Locking Ring	2.0N•m	
Wire Size	AWG16 ~ AWG14, 2 wires max.	
Weight (approx.)	18g	

Lamp Ratings

Rated Voltage	12V DC, 24V AC/DC, 120V AC
Voltage Range	12V DC ±5%, 24V AC/DC ±10%, 120V AC ±10%
LED Illumination Color	Red (R), Green (G), Yellow (Y), Amber (A), Blue (S), and White (PW)
Rated Current	12V DC: R, A, Y - 21mA; G, S, PW - 22mA 24V AC/DC, 120V AC: 24mA (all colors)
LED Life (Ref.)	Approx. 30,000 Hrs. at rated DC voltage at 25°C in specified environmental conditions (The brightness reduces to 50% of initial value.)

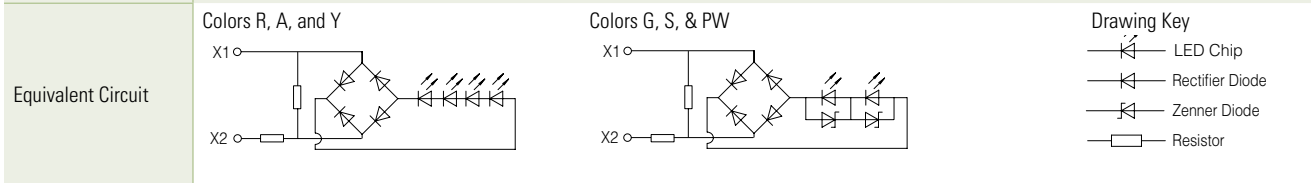

Dimensions (mm)

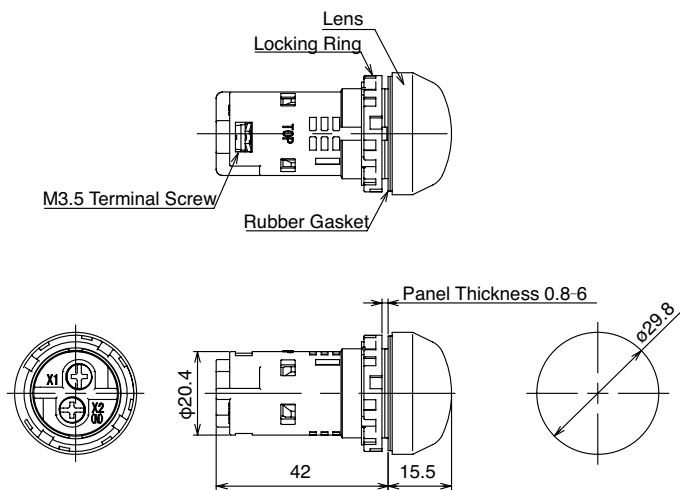

Panel cut-out (mm)

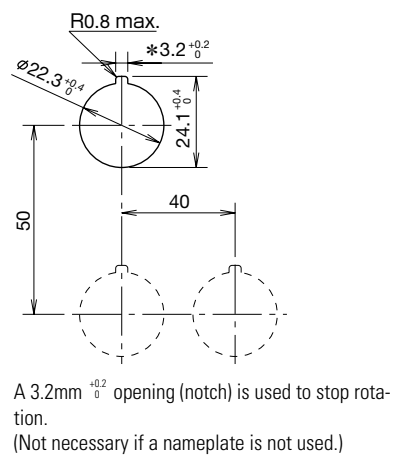



### Safety Instructions

Turn off the power before installation, removal, wiring, maintenance and inspection. Failure to turn off power may cause electrical shocks or fire hazard.

When wiring, use proper size (AWG16 - AWG14) wires to meet voltage and current requirements. Tighten the terminal screws to a recommended tightening torque (1.0N•m). Operating with loose terminal screws may cause overheating and fire.

### Installation Instructions

#### Panel Mounting

Remove the locking ring and check if the rubber gasket is properly aligned. Then insert the AP22M unit, aligning the "TOP" marking with the recess into the panel cut-out, and tighten the locking ring.

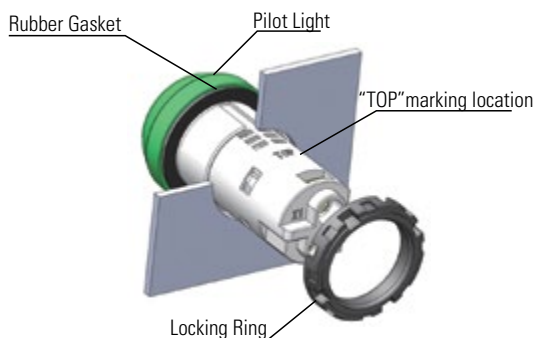

When installing the pilot light into a panel cut-out, use locking ring wrench (part number MW9Z-T1) to tighten the locking ring to a recommended torque of 2.0N•m. Do not use pliers and do not tighten excessively, otherwise the unit may become damaged.

#### Mounting Notes

##### Applicable Wires

The applicable wire sizes are from AWG14 to AWG16 with 2 wires max. A ring-tongue crimp style terminal cannot be used.

##### Applicable Terminal

###### Fork Crimp Terminal

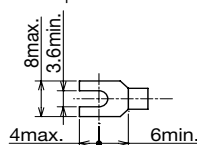

###### Bar Type Crimp Terminal

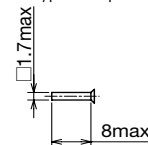

##### Single Wire

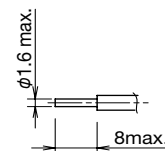

#### Noise

External noise may cause LED chips to deteriorate, leading to a reduction in brightness, a change in color, or malfunction. We recommend the following solution if this problem exists. However, please note that this solution will vary depending on the operating environment and the application.

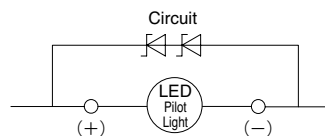

Zener Diode Reference Value  
Zener Voltage: 15V (1W)

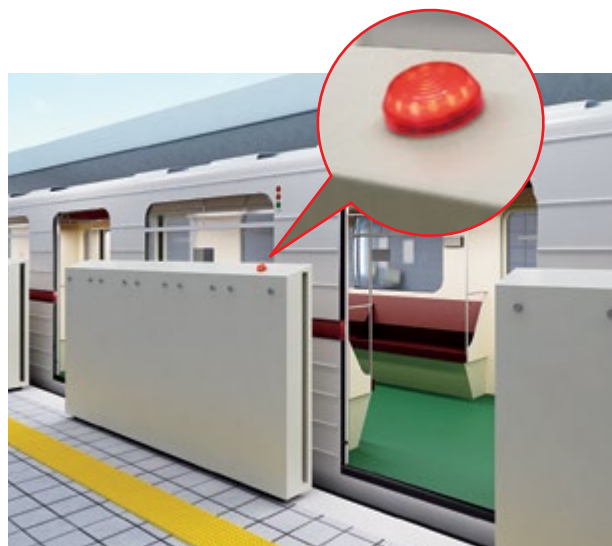

**Great Visibility** - even from inside a train (automatic safety fence on a train station platform)



**Compact Size** - Perfect for mounting on small or narrow surfaces.

ø22 Flush Mount CW Switches & Pilot Devices

Flush bezel projects only 2.5mm from front of panel and as little as 39.9mm behind the panel!

Key features:

- ø22.3mm mounting hole compliant with IEC 60947-5-1
- 3.5-mm operator travel for pushbuttons ensures comfortable and reliable operation
- Up to 6 contacts per switch are possible with use of dual contact blocks
- Black and metallic bezels available
- Illuminated pushbuttons, pushbuttons, pilot lights, selector switches and key selector switches are available
- Direct opening NC contact
- Seven different keys can be chosen for key selector switches
- 10A contact rating; up to three contact blocks for non-illuminated and two contact blocks for illuminated models can be connected
- Contact blocks can be removed by locking lever
- IP20 finger-safe screw terminals
- UL Type 4X rating



Applicable Standards	Mark	File No. or Organization
UL508 CSA C22.2 No.14		UL/c-UL File No. E68961
EN60947-5-1		TÜV SÜD
		EC Low Voltage Directive

Specifications

Operating Temperature	Non-illuminated: -25 to +60°C (no freezing) LED illuminated: -25 to +55°C (no freezing)
Operating Humidity	45 to 85% RH (no condensation)
Storage Temperature	-40 to +80°C
Contact Resistance	50 mΩ maximum (initial value)
Insulation Resistance	100 MΩ minimum (500V DC megger)
Overvoltage Category	II (IEC 60664-1)
Impulse Withstand Voltage	2.5 kV (IEC60664-1/60947-5-1)
Pollution Degree	3 (IEC60947-5-1)
Vibration Resistance	Operating extremes: 5 to 55Hz, amplitude 0.5mm
Shock Resistance	Operating extremes: 100m/s <sup>2</sup> Damage limits: 1000m/s <sup>2</sup>
Mechanical Life (minimum operations)	Pushbutton, illuminated pushbutton: 2,000,000 Selector switch: 250,000 Key selector switch: 250,000
Electrical Life (minimum operations)	50,000 (see Contact Ratings) 100,000 (see Contact Ratings) (switching frequency 1800 operations/h)
Degree of Protection (IEC60529)	Panel front: IP65 Terminals: IP20 Type 4X
Short-circuit Protection	250V/10A fuse, (Type aM IEC60269-1, IEC602069-2)
Electrical Shock Protection	Class II (IEC61140)
Terminal Style	Screw terminal (M3.5 slotted Phillips screw)
Bezel Material	Polyamide
Applicable Wire Size	Up to 2 wires of 2mm <sup>2</sup> (solid wire ø1.6) maximum (AWG14 to 16) (Ring terminal cannot be used)
Recommended Tightening Torque	Terminal: 1.0 to 1.3N-m Locking ring: 1.2N-m

Contact Ratings

Rated Insulation Voltage (Ui)		300V				
Rated Thermal Current (Ith)		10A				
Rated Operating Voltage (Ue)		24V	120V	240V		
Rated Operating Current (Ie)	Electrical Life 50,000 operations	AC 50/60Hz	Resistive Load (AC-12)	10A	10A	6A
			Inductive Load (AC-15)	10A	6A	3A
		DC	Resistive Load (DC-12)	8A	2.2A	1.1A
		Inductive Load (DC-13)	4A	1.1A	0.55A	
	Electrical Life 100,000 operations	AC 50/60Hz	Resistive Load (AC-12)	5A	5A	3A
			Inductive Load (AC-15)	5A	3A	1.5A
DC		Resistive Load (DC-12)	4A	1.1A	0.55A	
	Inductive Load (DC-13)	2A	0.55A	0.27A		
Contact Material		Silver				



1. Minimum applicable load (reference value): 3V AC/DC, 5mA (Applicable range is subject to the operating conditions and load.)
2. The operational current represents the classification by making and breaking currents (IEC 60947-5-1).
3. UL, c-UL rating: A300

Direct Opening of Key Selector Switch

	2-position (3NC)	3-position (2NC)
Operator Angle for Direct Opening Action	90°	45°
Minimum Operator Torque for Direct Opening Action	0.2N-m	0.3N-m
Maximum Operator Angle	90°	45°



**Weights**

Illuminated Pushbutton	46g (CW1L-M1E02QH, 2 contacts) 62g (CW1L-M1E22QH, 4 contacts)
Pushbutton	45g (CW1B-M1E03, 3 contacts) 52g (CW1B-M1E22, 4 contacts)
Pilot Light	27g (CW1P-1EQH)
Selector Switch	48g (CW1S-2E03, 3 contacts) 55g (CW1S-2E22, 4 contacts)
Key Selector Switch	61g (CW1K-2AE03, 3 contacts) 68g (CW1K-2AE22, 4 contacts)

**LED Module**

Rated Insulation Voltage (Ui)	250V				
Rated Operating Voltage (Ue)	6V AC/DC	12V AC/DC	24V AC/DC	100/120V AC	230/240V AC
Operating Voltage Range	6V AC/DC±10%	12V AC/DC±10%	24V AC/DC±10%	100/120V AC±10%	230/240V AC±10%
Illumination Color Code ②	A (amber), G (green), PW (white), R (red), S (blue)				
LED Module Part Number	CW-EAQ2②	CW-EAQ3②	CW-EAQ4②	CW-EAQH②	CW-EAQM4②
Current Draw	15mA	15mA	16.5mA	18mA	18mA
Life (reference value)	Approx. 30,000 hours				
Internal Circuit	<ul style="list-style-type: none"> <li>LED Chip</li> <li>Rectifying Diode</li> <li>Zener Diode</li> <li>Resistor</li> </ul>		<ul style="list-style-type: none"> <li>LED Chip</li> <li>Rectifying Diode</li> <li>Zener Diode</li> <li>Resistor</li> <li>Capacitor</li> </ul>		

1. Specify an illumination color code in place of ② in the part number.
2. Use the white (PW) LED module for yellow illumination.

**Contact Blocks**

Contact Block	Single Contact Block		Double Contact Block		
Contact	1NO	1NC	2NO	2NC	1NO-1NC
Part No.	YW-E10R	YW-E01	YW-EW2R0	YW-EW02	YW-EW1R1
Shape					
Housing Color	Blue/Black	Reddish Purple	Blue/Black	Reddish Purple	Reddish Purple/Blue
Push Rod Color	Black	Red	Black	Red	Gray
Terminal No.	3-4	1-2	1st tier: 13-14 2nd tier: 23-24	1st tier: 11-12 2nd tier: 21-22	1st tier: (NO) 13-14 2nd tier: (NC) 21-22
Weight (approx.)	11g		19g		

**Degree of Protection**

Rating	IP65	IP66	IP67	UL Type 4X
Illuminated Pushbutton	Yes	Yes *	Yes *	Yes *
Pilot Light	Yes	Yes	No	Yes
Pushbutton	Yes	Yes *	Yes *	Yes *
Selector Switch	Yes	Yes	Yes	Yes
Key Selector Switch	Yes	Yes	No	Yes

\*When used with rubber boot (CW9Z-D11, -D12)

**Mounting Hole Layout**  
IEC 60947-5-1 compliant

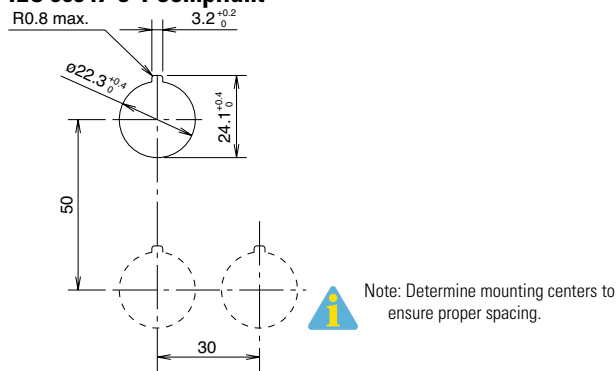

**Illuminated Pushbuttons (Assembled)**

Style	Operating Voltage	Contact Configuration	Black Bezel	Metallic Bezel	Illumination Color Code ②
Round Flush CW□L-□1   (black bezel)   (metallic bezel)	6V AC/DC	1NO 1NC 1NO-1NC 2NO 2NC 2NO-2NC	CW1L-③1E10Q2② CW1L-③1E01Q2② CW1L-③1E11Q2② CW1L-③1E20Q2② CW1L-③1E02Q2② CW1L-③1E22Q2②	CW4L-③1E10Q2② CW4L-③1E01Q2② CW4L-③1E11Q2② CW4L-③1E20Q2② CW4L-③1E02Q3② CW4L-③1E22Q2②	A: amber G: green PW: white R: red S: blue Y: yellow
	12V AC/DC	1NO 1NC 1NO-1NC 2NO 2NC 2NO-2NC	CW1L-③1E10Q3② CW1L-③1E01Q3② CW1L-③1E11Q3② CW1L-③1E20Q3② CW1L-③1E02Q3② CW4L-③1E02Q3②	CW4L-③1E10Q3② CW4L-③1E01Q3② CW4L-③1E11Q3② CW4L-③1E20Q3② CW4L-③1E02Q3② CW4L-③1E02Q3②	
	24V AC/DC	1NO 1NC 1NO-1NC 2NO 2NC 2NO-2NC	CW1L-③1E10Q4② CW1L-③1E01Q4② CW1L-③1E11Q4② CW1L-③1E20Q4② CW1L-③1E02Q4② CW1L-③1E22Q4②	CW4L-③1E10Q4② CW4L-③1E01Q4② CW4L-③1E11Q4② CW4L-③1E20Q4② CW4L-③1E02Q4② CW4L-③1E22Q4②	
	100/120V AC	1NO 1NC 1NO-1NC 2NO 2NC 2NO-2NC	CW1L-③1E10QH② CW1L-③1E01QH② CW1L-③1E11QH② CW1L-③1E20QH② CW1L-③1E02QH② CW1L-③1E22QH②	CW4L-③1E10QH② CW4L-③1E01QH② CW4L-③1E11QH② CW4L-③1E20QH② CW4L-③1E02QH② CW4L-③1E22QH②	
	230/240V AC	1NO 1NC 1NO-1NC 2NO 2NC 2NO-2NC	CW1L-③1E10QM4② CW1L-③1E01QM4② CW1L-③1E11QM4② CW1L-③1E20QM4② CW1L-③1E02QM4② CW4L-③1E22QM4②	CW4L-③1E10QM4② CW4L-③1E01QM4② CW4L-③1E11QM4② CW4L-③1E20QM4② CW4L-③1E02QM4② CW4L-③1E22QM4②	
Round Extended CW□L-□2   (black bezel)   (metallic bezel)	6V AC/DC	1NO 1NC 1NO-1NC 2NO 2NC 2NO-2NC	CW1L-③2E10Q2② CW1L-③2E01Q2② CW1L-③2E11Q2② CW1L-③2E20Q2② CW1L-③2E02Q2② CW1L-③2E22Q2②	CW4L-③2E10Q2② CW4L-③2E01Q2② CW4L-③2E11Q2② CW4L-③2E20Q2② CW4L-③2E02Q2② CW4L-③2E22Q2②	
	12V AC/DC	1NO 1NC 1NO-1NC 2NO 2NC 2NO-2NC	CW1L-③2E10Q3② CW1L-③2E01Q3② CW1L-③2E11Q3② CW1L-③2E20Q3② CW1L-③2E02Q3② CW1L-③2E22Q3②	CW4L-③2E10Q3② CW4L-③2E01Q3② CW4L-③2E11Q3② CW4L-③2E20Q3② CW4L-③2E02Q3② CW4L-③2E22Q3②	
	24V AC/DC	1NO 1NC 1NO-1NC 2NO 2NC 2NO-2NC	CW1L-③2E10Q4② CW1L-③2E01Q4② CW1L-③2E11Q4② CW1L-③2E20Q4② CW1L-③2E02Q4② CW1L-③2E22Q4②	CW4L-③2E10Q4② CW4L-③2E01Q4② CW4L-③2E11Q4② CW4L-③2E20Q4② CW4L-③2E02Q4② CW4L-③2E22Q4②	
	100/120V AC	1NO 1NC 1NO-1NC 2NO 2NC 2NO-2NC	CW1L-③2E10QH② CW1L-③2E01QH② CW1L-③2E11QH② CW1L-③2E20QH② CW1L-③2E02QH② CW1L-③2E22QH②	CW4L-③2E10QH② CW4L-③2E01QH② CW4L-③2E11QH② CW4L-③2E20QH② CW4L-③2E02QH② CW4L-③2E22QH②	
	230/240V AC	1NO 1NC 1NO-1NC 2NO 2NC 2NO-2NC	CW1L-③2E10QM4② CW1L-③2E01QM4② CW1L-③2E11QM4② CW1L-③2E20QM4② CW1L-③2E02QM4② CW4L-③2E22QM4②	CW4L-③2E10QM4② CW4L-③2E01QM4② CW4L-③2E11QM4② CW4L-③2E20QM4② CW4L-③2E02QM4② CW4L-③2E22QM4②	



1. Specify an illumination color code in place of ② in the Part Number.
2. Specify function code in place of ③ in the Part Number. M: momentary, A: maintained
3. See page 594 for dimensions.
4. See next page for replacement LED modules.
5. A dummy block is installed when one contact block is used.
6. Additional contact configurations available, contact IDEC for more details

Illuminated Pushbuttons (Sub-assembled)

Contact Blocks + LED Module + Mounting Adapter + Operator + Lens = Completed Unit



Contact Blocks

Style	Contacts	Contact Block	Contact Configuration	Part Number
	Finger-safe screw terminal	Single	1NO	YW-E10R
			1NC	YW-E01
	Finger-safe screw terminal	Double	2NO	YW-EW2R0
			2NC	YW-EW02
			1NO-1NC	YW-EW1R1
	Dummy block			CW-DB

LED Module

Style	Part Number
	CW-EAQ ②①

- 1. In place of ①, specify the Lens/LED Color Code from table.
- 2. In place of ②, specify the Voltage Code from table.
- 3. Use PW LED for yellow lens.

Operators

Style			Black Bezel	Metallic Bezel
	Momentary	Round Flush	CW1L-M10	CW4L-M10
		Round Extended	CW1L-M20	CW4L-M20
	Maintained	Round Flush	CW1L-A10	CW4L-A10
		Round Extended	CW1L-A20	CW4L-A20

Lens

Style		Part Number
	Round Flush	CW9Z-L11①
	Round Extended	CW9Z-L12①

- 1. In place of ①, specify the Lens/LED Color Code from table.

Contact Block Mounting Adaptor

Style	Part Number
	CW-CN

① Lens/LED Color Code

Color	Code
Amber	A
Green	G
Red	R
Blue	S
White*	PW or C
Yellow	Y

\*Use PW for LED module, use C for lens.

② Voltage Code

Voltage	Code
6V AC/DC	2
12V AC/DC	3
24V AC/DC	4
100/120V AC	H
230/240V AC	M4

Non-Illuminated Pushbuttons (Assembled)

Style	Contact Configuration	Black Bezel	Metallic Bezel	Button Color Code ①
Round Flush CW□B-□1  (black bezel)	1NO	CW1B-③1E10①	CW4B-③1E10①	B: black G: green R: red S: blue W: white Y: yellow
	1NC	CW1B-③1E01①	CW4B-③1E01①	
	1NO-1NC	CW1B-③1E11①	CW4B-③1E11①	
	2NO	CW1B-③1E20①	CW4B-③1E20①	
	2NC	CW1B-③1E02①	CW4B-③1E02①	
	2NO-1NC*	CW1B-M1E21①	CW4B-M1E21①	
	1NO-2NC*	CW1B-M1E12①	CW4B-M1E12①	
	3NO*	CW1B-M1E30①	CW4B-M1E30①	
	3NC*	CW1B-M1E03①	CW4B-M1E03①	
	2NO-2NC	CW1B-③1E22j	CW4B-③1E22j	
Round Extended CW□B-□2  (metallic bezel)	1NO	CW1B-③2E10①	CW4B-③2E10①	
	1NC	CW1B-③2E01①	CW4B-③2E01①	
	1NO-1NC	CW1B-③2E11①	CW4B-③2E11①	
	2NO	CW1B-③2E20①	CW4B-③2E20①	
	2NC	CW1B-③2E02①	CW4B-③2E02①	
	2NO-1NC*	CW1B-M2E21①	CW4B-M2E21①	
	1NO-2NC*	CW1B-M2E12①	CW4B-M2E12①	
	3NO*	CW1B-M2E30①	CW4B-M2E30①	
	3NC*	CW1B-M2E03①	CW4B-M2E03①	
	2NO-2NC	CW1B-M2E22①	CW4B-③2E22①	



- 1. Specify a button color code in place of ① in the part number.
- 2. Specify function code in place of ③ in the Part Number. M: momentary, A: maintained
- 3. See page 595 for dimensions.
- 4. Two dummy blocks are installed when one contact is used and one dummy block in installed when two contact blocks are used.
- 5. \*These contact configurations are not available in maintained action
- 6. Additional contact configurations available; contact IDEC for more details.

Non-Illuminated Pushbuttons (Sub-assembled)



Contact Blocks + Mounting Adaptor + Operator = Completed Unit



Contact Blocks

Style	Contacts	Contact Block	Contact Configuration	Part Number
	Single	Finger-safe screw terminal	1NO	YW-E10R
			1NC	YW-E01
	Double	Finger-safe screw terminal	2NO	YW-EW2R0
			2NC	YW-EW02
	Dummy block		1NO-1NC	YW-EW1R1
				CW-DB

Operators\*

Style		Black Bezel	Metallic Bezel
	Momentary		
	Round Flush	CW1B-M1①	CW4B-M1①
	Maintained		
	Round Extended	CW1B-M2①	CW4B-M2①
	Round Flush	CW1B-A1①	CW4B-A1①
	Round Extended	CW1B-A2①	CW4B-A2①

① Button Color Code

Color	Code
Black	B
Green	G
Red	R
Blue	S
White	W
Yellow	Y

- 1. Specify a button color code in place of ①.
- 2. \*Operator button is not removable from operator.

Contact Block Mounting Adaptor

Style	Part Number
	CW-CN

Pilot Lights (Assembled)

Style	Operating Voltage	Black Bezel	Metallic Bezel	Illumination Color Code ②
Round Flush Lens CW□P-1   (black bezel)	6V AC/DC	CW1P-1EQ2②	CW4P-1EQ2②	A: amber G: green R: red S: blue PW: white Y: yellow
	12V AC/DC	CW1P-1EQ3②	CW4P-1EQ3②	
	24V AC/DC	CW1P-1EQ4②	CW4P-1EQ4②	
	100/120V AC	CW1P-1EQH②	CW4P-1EQH②	
	230/240V AC	CW1P-1EQM4②	CW4P-1EQM4②	
Round Dome Lens CW□P-2   (metallic bezel)	6V AC/DC	CW1P-2EQ2②	CW4P-2EQ2②	
	12V AC/DC	CW1P-2EQ3②	CW4P-2EQ3②	
	24V AC/DC	CW1P-2EQ4②	CW4P-2EQ4②	
	100/120V AC	CW1P-2EQH②	CW4P-2EQH②	
	230/240V AC	CW1P-2EQM4②	CW4P-2EQM4②	



- Specify an illumination color code in place of ② in the Part Number
- See page 595 for dimensions.
- See page 593 for replacement LED modules.
- Two dummy blocks are installed.

Pilot Lights (Sub-assembled)



\* 2 dummy blocks are required for each completed pilot light.

Contact Block

Style	Contacts	Part Number
	Dummy Block	CW-DB

LED Module

Style	Part Number
	CW-EAQ ②①

- In place of ①, specify the Lens/LED Color Code from table.
- In place of ②, specify the Voltage Code from table.
- Use PW LED for yellow lens.



Contact Block Mounting Adaptor

Style	Part Number
	CW-CN

Operators

Style	Black Bezel	Metallic Bezel
	CW1P-00	CW4P-00

Lens

Style	Part Number
	Round Flush CW9Z-L11①
	Round Dome CW9Z-L15①



- In place of ①, specify the Lens/LED Color Code from table.

① Lens/LED Color Code





Color	Code
Amber	A
Green	G
Red	R
Blue	S
White*	PW or C
Yellow	Y

② Voltage Code





Voltage	Code
6V AC/DC	2
12V AC/DC	3
24V AC/DC	4
100/120V AC	H
230/240V AC	M4

\*Use PW for LED module, use C for lens.

Selector Switches (Assembled)

Shape	CW□S (Knob Operator)						
			(black bezel)		(metallic bezel)		
No. of Positions	Contact Configuration	Contact Block		Operator Position			
		Mounting Position	Type	L	R	Maintained	Spring return from right
90° 2-position	1NO (10)	1	NO		●	CW□S-2E10	CW□S-21E10
		2	—	Dummy			
		3	—	Dummy			
	1NC (01)	1	—	Dummy		CW□S-2E01	CW□S-21E01
		2	—	Dummy			
		3	NC	●			
	1NO-1NC (11)	1	NO		●	CW□S-2E11	CW□S-21E11
		2	—	Dummy			
		3	NC	●			
	2NO (20)	1	NO		●	CW□S-2E20	CW□S-21E20
		2	—	Dummy			
		3	NO		●		
	2NC (02)	1	NC	●		CW□S-2E02	CW□S-21E02
		2	—	Dummy			
		3	NC	●			
	2NO-1NC (21)	1	NO		●	CW□S-2E21	CW□S-21E21
		2	NO		●		
		3	NC	●			
	1NO-2NC (12)	1	NO		●	CW□S-2E12	CW□S-21E12
		2	NC	●			
		3	NC	●			
	3NO (30)	1	NO		●	CW□S-2E30	CW□S-21E30
		2	NO		●		
		3	NO		●		
3NC (03)	1	NC	●		CW□S-2E03	CW□S-21E03	
	2	NC	●				
	3	NC	●				
2NO-2NC (22)	1	NO/ NC	NC		●	CW□S-2E22	CW□S-21E22
	2	—	Dummy				
	3	NO/ NC	NO		●		
4NO (40)	1	2NO	NO		●	CW□S-21E40	CW□S-21E40
			NO		●		
	2	—	Dummy				
	3	2NO	NO		●		
			NO		●		

Selector Switches (Assembled) con't

No. of Positions	Contact Configuration	Contact Block		Operator Position						
		Mounting Position	Type	L	C	R	Maintained	Spring return from right	Spring return from left	Spring return two-way
45° 3-position	1NO-1NC (11)	1	NO	●			CW□S-3E11	CW□S-31E11	CW□S-32E11	CW□S-33E11
		2	—		Dummy					
		3	NC	■						
	1NO-1NC (11N1)	1	NC			■	CW□S-3E11N1	CW□S-31E11N1	CW□S-32E11N1	CW□S-33E11N1
		2	—		Dummy					
		3	NO			●				
	1NO-1NC (11N2)	1	NO	●			CW□S-3E11N2	CW□S-31E11N2	CW□S-32E11N2	CW□S-33E11N2
		2	NC		●					
		3	—		Dummy					
	1NO-1NC (11N3)	1	—		Dummy		CW□S-3E11N3	CW□S-31E11N3	CW□S-32E11N3	CW□S-33E11N3
		2	NC		●					
		3	NO			●				
	1NO-1NC (11N4)	1	—		Dummy		CW□S-3E11N4	CW□S-31E11N4	CW□S-32E11N4	CW□S-33E11N4
		2	NO	●		●				
		3	NC	■						
	2NO (20)	1	NO	●			CW□S-3E20	CW□S-31E20	CW□S-32E20	CW□S-33E20
		2	—		Dummy					
		3	NO			●				
	2NO (20N1)	1	—		Dummy		CW□S-3E20N1	CW□S-31E20N1	CW□S-32E20N1	CW□S-33E20N1
		2	NO	●		●				
		3	NO			●				
	2NC (02)	1	NC			■	CW□S-3E02	CW□S-31E02	CW□S-32E02	CW□S-33E02
		2	—		Dummy					
		3	NC	■						
	2NC (02N1)	1	—		Dummy		CW□S-3E02N1	CW□S-31E02N1	CW□S-32E02N1	CW□S-33E02N1
		2	NC		●					
		3	NC	■						
	2NO-1NC (21)	1	NO	●			CW□S-3E21	CW□S-31E21	CW□S-32E21	CW□S-33E21
		2	NO	●		●				
		3	NC	■						
2NO-1NC (21N1)	1	NO	●			CW□S-3E21N1	CW□S-31E21N1	CW□S-32E21N1	CW□S-33E21N1	
	2	NC		●						
	3	NO			●					
1NO-2NC (12)	1	NO	●			CW□S-3E12	CW□S-31E12	CW□S-32E12	CW□S-33E12	
	2	NC		●						
	3	NC	■							
1NO-2NC (12N1)	1	NC			■	CW□S-3E12N1	CW□S-31E12N1	CW□S-32E12N1	CW□S-33E12N1	
	2	NO	●		●					
	3	NC	■							
3NO (30)	1	NO	●			CW□S-3E30	CW□S-31E30	CW□S-32E30	CW□S-33E30	
	2	NO	●		●					
	3	NO			●					
3NC (03)	1	NC			■	CW□S-3E03	CW□S-31E03	CW□S-32E03	CW□S-33E03	
	2	NC		●						
	3	NC	■							

Switches & Pilot Devices

Signaling Lights

Relays & Sockets

Timers





Contactors

Terminal Blocks

Circuit Breakers



Selector Switches (Assembled) con't

No. of Positions	Contact Configuration	Contact Block		Operator Position			 Maintained	 Spring return from right	 Spring return from left	 Spring return two-way		
		Mounting Position	Type	L	C	R						
45° 3-position	2NO-2NC (22)	1	NO/NC NO/NC	●	■		CW□S-3E22	CW□S-31E22	CW□S-32E22	CW□S-33E22		
		2	—		Dummy							
		3	NO/NC NO/NC	■		●						
	4NO (40)	4NO (40)	1	2NO NO/NO	● ●	■		CW□S-3E40	CW□S-31E40	CW□S-32E40	CW□S-33E40	
			2	—		Dummy						
			3	2NO NO/NO	■		● ●					
	2NO-2NC (22N2)	2NO-2NC (22N2)	1	2NC NC/NC	■		■	CW□S-3E22N2	CW□S-31E22N2	CW□S-32E22N2	CW□S-33E22N2	
			2	—		Dummy						
			3	2NO NC/NC	■		● ●					

- 1. Specify a bezel color code in place of □ in the Part Number, 1 (black bezel), 4 (metallic bezel)
- 2. For the contact block mounting position, see below.
- 3. Lever operator is also available. For dimensions, see page 596.
- 4. To order a lever operator selector switch, insert L before E in the knob operator part number.  
Example: Knob Operator part number CW1S-3E11 becomes CW1S-3LE11 for Lever Operator.

Lever Operator

Contact Block Mounting Position



CW1S-□L  
(black bezel)



CW4S-□L  
(metallic bezel)



		Left	Center	Right	Operator Position
		L	C	R	
1	NO	●			
2	NC		●		
3	NC	■			



**Selector Switches (Sub-assembled)**

Contact Block + Mounting Adaptor + Operator = Completed Unit



**Contact Blocks**

Style	Contacts	Contact Block	Contact Configuration	Part Number
	Finger-safe screw terminal	Single	1NO	YW-E10R
			1NC	YW-E01
	Finger-safe screw terminal	Double	2NO	YW-EW2R0
			2NC	YW-EW02
			1NO-1NC	YW-EW1R1
	Dummy block			CW-DB

**Contact Block Mounting Adaptor**

Style	Part Number
	CW-CN

**Operators**





Style	Position	Handle	Description	Black Bezel	Metallic Bezel
	2-position	Knob	Maintained	CW1S-2	CW4S-2
			Spring return from right	CW1S-21	CW4S-21
		Lever	Maintained	CW1S-2L	CW4S-2L
			Spring return from right	CW1S-21L	CW4S-21L
 (knob operator shown)	3-position	Knob	Maintained	CW1S-3	CW4S-3
			Spring return from right	CW1S-31	CW4S-31
			Spring return from left	CW1S-32	CW4S-32
		Lever	Spring return two-way	CW1S-33	CW4S-33
			Maintained	CW1S-3L	CW4S-3L
			Spring return from right	CW1S-31L	CW4S-31L
			Spring return from left	CW1S-32L	CW4S-32L
			Spring return two-way	CW1S-33L	CW4S-33L

Lever or knob is supplied with operator.

Key Selector Switches (Assembled)

Shape	CW□K		Contact Block		Operator Position		 Maintained	 Spring return from right	
	No. of Positions	Contact Configuration	Mounting Position	Type	L	R			
Shape			 (black bezel)		 (metallic bezel)				
90° 2-position	1NO (10)	1	NO			●	CW□K-2AE10	CW□K-21BE10	
		2	—	Dummy					
		3	—	Dummy					
	1NC (01)	1	—	Dummy				CW□K-2AE01	CW□K-21BE01
		2	—	Dummy					
		3	NC	●					
	1NO-1NC (11)	1	NO			●	CW□K-2AE11	CW□K-21BE11	
		2	—	Dummy					
		3	NC	●					
	2NO (20)	1	NO			●	CW□K-2AE20	CW□K-21BE20	
		2	—	Dummy					
		3	NO			●			
	2NC (02)	1	NC	●			CW□K-2AE02	CW□K-21BE02	
		2	—	Dummy					
		3	NC	●					
	2NO-1NC (21)	1	NO			●	CW□K-2AE21	CW□K-21BE21	
		2	NO			●			
		3	NC	●					
	1NO-2NC (12)	1	NO			●	CW□K-2AE12	CW□K-21BE12	
		2	NC	●					
		3	NC	●					
	3NO (30)	1	NO			●	CW□K-2AE30	CW□K-21BE30	
		2	NO			●			
		3	NO			●			
3NC (03)	1	NC	●			CW□K-2AE03	CW□K-21BE03		
	2	NC	●						
	3	NC	●						
2NO-2NC (22)	1	NO/NC	NO		●	CW□K-2AE22	CW□K-21BE22		
	2	—	Dummy						
	3	NO/NC	NO		●				
4NO (40)	1	2NO	NO		●	CW□K-2AE40	CW□K-21BE40		
	2	—	Dummy						
	3	2NO	NO		●				

Key Selector Switches (Assembled) con't

No. of Positions	Contact Configuration	Contact Block		Operator Position						
		Mounting Position	Type	L	C	R	Maintained	Spring return from right	Spring return from left	Spring return two-way
45° 3-position	1NO-1NC (11)	1	NO	●						
		2	—		Dummy		CW□K-3AE11	CW□K-31BE11	CW□K-32CE11	CW□K-33DE11
		3	NC	■						
	1NO-1NC (11N1)	1	NC		■					
		2	—		Dummy		CW□K-3AE11N1	CW□K-31BE11N1	CW□K-32CE11N1	CW□K-33DE11N1
		3	NO			●				
	1NO-1NC (11N2)	1	NO	●						
		2	NC		●		CW□K-3AE11N2	CW□K-31BE11N2	CW□K-32CE11N2	CW□K-33DE11N2
		3	—		Dummy					
	1NO-1NC (11N3)	1	—		Dummy					
		2	NC		●		CW□K-3AE11N3	CW□K-31BE11N3	CW□K-32CE11N3	CW□K-33DE11N3
		3	NO			●				
	1NO-1NC (11N4)	1	—		Dummy					
		2	NO	●		●	CW□K-3AE11N4	CW□K-31BE11N4	CW□K-32CE11N4	CW□K-33DE11N4
		3	NC	■						
	2NO (20)	1	NO	●						
		2	—		Dummy		CW□K-3AE20	CW□K-31BE20	CW□K-32CE20	CW□K-33DE20
		3	NO			●				
	2NO (20N1)	1	—		Dummy					
		2	NO	●		●	CW□K-3AE20N1	CW□K-31BE20N1	CW□K-32CE20N1	CW□K-33DE20N1
		3	NO			●				
	2NC (02)	1	NC		■					
		2	—		Dummy		CW□K-3AE02	CW□K-31BE02	CW□K-32CE02	CW□K-33DE02
		3	NC	■						
2NC (02N1)	1	—		Dummy						
	2	NC		●		CW□K-3AE02N1	CW□K-31BE02N1	CW□K-32CE02N1	CW□K-33DE02N1	
	3	NC	■							
2NO-1NC (21)	1	NO	●							
	2	NO	●		●	CW□K-3AE21	CW□K-31BE21	CW□K-32CE21	CW□K-33DE21	
	3	NC	■							
2NO-1NC (21N1)	1	NO	●							
	2	NC		●		CW□K-3AE21N1	CW□K-31BE21N1	CW□K-32CE21N1	CW□K-33DE21N1	
	3	NO			●					
1NO-2NC (12)	1	NO	●							
	2	NC		●		CW□K-3AE12	CW□K-31BE12	CW□K-32CE12	CW□K-33DE12	
	3	NC	■							
1NO-2NC (12N1)	1	NC		■						
	2	NO	●		●	CW□K-3AE12N1	CW□K-31BE12N1	CW□K-32CE12N1	CW□K-33DE12N1	
	3	NC	■							
3NO (30)	1	NO	●							
	2	NO	●		●	CW□K-3AE30	CW□K-31BE30	CW□K-32CE30	CW□K-33DE30	
	3	NO			●					
3NC (03)	1	NC		■						
	2	NC		●		CW□K-3AE03	CW□K-31BE03	CW□K-32CE03	CW□K-33DE03	
	3	NC	■							

Switches & Pilot Devices

Signaling Lights

Relays & Sockets

Timers

Contactors

Terminal Blocks

Circuit Breakers

**Key Selector Switches (Assembled) con't**

No. of Positions	Contact Configuration	Contact Block		Operator Position			L C R Maintained	L C R Spring return from right	L C R Spring return from left	L C R Spring return two-way
		Mounting Position	Type	L	C	R				
90° 2-position	2NO-2NC (22)	1	NO/NC NO NC	●	■		CW□K-3AE22	CW□K-31BE22	CW□K-32CE22	CW□K-33DE22
		2	—		■	●				
		3	NO/NC NO NC		■					
	4NO (40)	1	2NO NO NO	●			CW□K-3AE40	CW□K-31BE40	CW□K-32CE40	CW□K-33DE40
		2	—		■	●				
		3	2NO NO NO			●				
	2NO-2NC (22N2)	1	2NC NC NC		■	■	CW□K-3AE22N2	CW□K-31BE22N2	CW□K-32CE22N2	CW□K-33DE22N2
		2	—		■	●				
		3	2NC NC NC			●				



- Specify a bezel color code in place of □ in the Part Number: 1 (black bezel), 4 (metallic bezel).
- On the spring-returned models, the key can be released only from the maintained position. On the maintained models, the key can be released from any position. Key retained positions are also available. See below.
- Two keys are supplied.
- Key cylinder material: Metal
- Besides the standard key (key number 0H), six other keys are also available. See below.
- For the contact block mounting position, see right.
- For dimensions, see page 597.
- When ordering an optional key or optional key-retained positions, specify designation codes as shown below:  
Example: CW1K-2AE10-1H

blank: Standard key (0H, reversible)  
 1H to 2H: Reversible key  
 3H to 6H: Non-reversible key  
 Key removal position code  
 2-position  
 A: Removable in all positions  
 B: Removable in left only  
 C: Removable in right only

3-position  
 A: Removable in all positions  
 B: Removable in left and center  
 C: Removable in right and center  
 D: Removable in center only  
 E: Removable in right and left  
 G: Removable in left only  
 H: Removable in right only

Note: Key is retained in all spring-returned positions.

**Contact Block Mounting Position**



		Left	Center	Right	Operator Position
		L	C	R	
1	NO	●			
2	NC		●		
3	NC		■		

Note:  
Key number is indicated on the key cylinder.  
Standard keys do not have a key number indication.

**Key Selector Switches (Sub-assembled)**

Contact Block + Mounting Adaptor + Operator = Completed Unit



**Contact Blocks**

Style	Contacts	Contact Block	Contact Configuration	Part Number
	Finger-safe screw terminal	Single	1NO	YW-E10R
			1NC	YW-E01
	Finger-safe screw terminal	Double	2NO	YW-EW2R0
			2NC	YW-EW02
			1NO-1NC	YW-EW1R1
	Dummy block			CW-DB

**Contact Block Mounting Adaptor**



Style	Part Number
	CW-CN

**Operator**





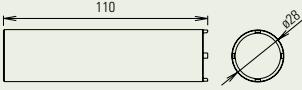

Style	Position	Description	Black Bezel	Metallic Bezel	
 	2-position	Maintained, key removable all positions	CW1K-2A	CW4K-2A	
		Maintained, key removable left position only	CW1K-2B	CW4K-2B	
		Maintained, key removable right position only	CW1K-2C	CW4K-2C	
		Spring return from right	CW1K-21B	CW4K-21B	
	3-position		Maintained, key removable all positions	CW1K-3A	CW1K-3A
			Maintained, key removable left and center positions only	CW1K-3B	CW4K-3B
			Maintained, key removable right and center positions only	CW1K-3C	CW4K-3C
			Maintained, key removable center position only	CW1K-3D	CW4K-3D
			Maintained, key removable left and right positions only	CW1K-3E	CW4K-3E
			Maintained, key removable left position only	CW1K-3G	CW4K-3G
			Maintained, key removable right position only	CW1K-3H	CW4K-3H
			Spring return from right, key removable left and center positions only	CW1K-31B	CW4K-31B
			Spring return from right, key removable center position only	CW1K-31D	CW4K-31D
			Spring return from right, key removable left position only	CW1K-31G	CW4K-31G
			Spring return from left, key removable right and center positions only	CW1K-32C	CW4K-32C
			Spring return from left, key removable center position only	CW1K-32D	CW4K-32D
Spring return from left, key removable right position only	CW1K-32H	CW4K-32H			
Spring return two-way, key removable center position only	CW1K-33D	CW4K-33D			

Two keys supplied with operator.

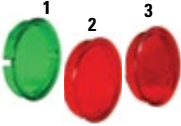
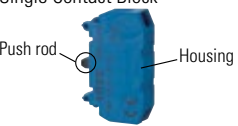
Accessories

Item	Appearance	Material	Part Number	Remarks
Locking Ring Wrench		Brass	MW9Z-T1	<ul style="list-style-type: none"> <li>Used to tighten the locking ring when installing the CW series control unit in a panel cut-out</li> <li>Weight: Approx 150g</li> </ul> 
Mounting Hole Plug		Polyamide (black)	LW9Z-BP1	<ul style="list-style-type: none"> <li>Used to plug an unnecessary ø22.3mm hole in the panel</li> <li>Degree of protection: IP65</li> <li>Panel thickness: 0.8 to 6.0mm</li> </ul>

Replacement Parts

Shape	Material	Part Number	Remarks
Lens 	1 Round Flush	Polyalylate	CW9Z-L11Ⓞ
	2 Round Extended	Polyalylate	CW9Z-L12Ⓞ
	3 Round Dome	Polyalylate	CW9Z-L15Ⓞ
Single Contact Block 	1NO		YW-E10R
	1NC		YW-E01
	Double Contact Block 	2NO	
Timers 	2NC		YW-EW02
	1NO, 1NC		YW-EW1R1
	Contactors Rubber Boot (clear) 	Round Flush	
Round Extended			CW9Z-D12
Dummy Block 	Polyamide (black)		CW-DB
Locking Ring 	Polyamide (black)		CW9Z-LN
Terminal Blocks Gasket 	Nitrile rubber		CW9Z-WM
Nameplate 	Plastic		CWAM-OB
Circuit Breakers Spare Key 	Zinc (nickel-plated)		LA9Z-SK-□

LED Modules

Shape	Operating Voltage Range	Current Draw	Part Number	Illumination Color Code ②
	6V AC/DC±10%	15mA	CW-EAQ2②	Specify an illumination color code in place of ② in the Part Number A: amber G: green PW: white R: red S: blue
	12V AC/DC±10%	15mA	CW-EAQ3②	
	24V AC/DC±10%	16.5mA	CW-EAQ4②	
	100/120V AC±10%	18mA	CW-EAQH②	
	230/240V AC±10%	18mA	CW-EAQM4②	

Nameplate

**CWAM-Black Plastic**

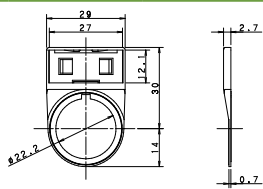

Nameplate (blank engraving plate included)	CWAM-OB	
Nameplate (engraved)	CWAM-①	
Additional Insert (blank)	HWNP-O	HWNP Dimensions
Additional Insert (engraved)	HWNP-①	

Standard Legend Codes

Pushbuttons				Pushbuttons/Selector Switches				Selector Switches	
Legend	Code	Legend	Code	Legend	Code	Legend	Code	Legend	Code
AUTO	101	OPEN	116	AUTO-MAN	201	REV-FOR	216	AUTO-MAN-OFF	301
CLOSE	102	OUT	117	CLOSE-OPEN	202	RUN-JOG	217	AUTO-OFF-MAN	302
DOWN	103	RAISE	118	DOWN-UP	203	RUN-SAFE	218	CLOSE-OFF-OPEN	303
EMERG.	104	RESET	119	FAST-SLOW	204	SAFE-RUN	219	DOWN-OFF-SLOW	304
STOP	105	REVERSE	120	FOR-REV	205	SLOW-FAST	220	FAST-OFF-SLOW	305
FAST	106	RUN	121	HAND-AUTO	206	START-STOP	221	FOR-OFF-REV	306
FORWARD	107	SLOW	122	HIGH-LOW	207	STOP-START	222	LEFT-OFF-RIGHT	307
HAND	108	START	123	JOG-RUN	208	UP-DOWN	223	LOWER-OFF-RAISE	308
HIGH	109	STOP	125	LEFT-RIGHT	209	OI (Int'l OFF ON)	250	OFF-MAN-AUTO	309
IN	110	TEST	126	LOWER-	210			OFF-SLOW-FAST	310
INCH	111	UP	127	RAISE	211			OFF-1-2	311
JOG	112	I (Int'l On)	150	MAN-AUTO	212			OPEN-OFF-CLOSE	312
LOW	113	O (Int'l Off)	151	OFF-ON	213			SLOW-OFF-FAST	313
LOWER	114	Off	152	ON-OFF	214			SUMMER-OFF-WINTER	314
OFF	115	EMO		OPEN-CLOSE	215			UP-OFF-DOWN	315
ON				RAISE-LOWER				1-OFF-2	316
								HAND-OFF-AUTO	317

- To order engraved nameplates, add legend code to nameplate part number.
- Character height based on the number of characters and size of nameplate. Standard character size is 3/16".
- Nameplates with standard legends are the same list price as blank nameplates.

- In place of ①, insert either the standard legend code from table below or custom engraving delimited by " ".
- Standard engravings are available at no charge.

Nameplates Order Form – CW Series

Copy this order form and use it to specify Letter Height, Custom Engravings, Location of Engraving on Nameplate, and Quantity Desired.

To ensure engraving accuracy, fax it to your IDEC representative or Distributor.

Your Company: \_\_\_\_\_

Name: \_\_\_\_\_

Telephone: \_\_\_\_\_

Fax & Email: \_\_\_\_\_

IDEC Rep/Distributor Contact: \_\_\_\_\_

PO number (if known): \_\_\_\_\_

IDEC Rep/Distributor Phone: \_\_\_\_\_

IDEC Rep/Distributor Fax & Email: \_\_\_\_\_

CWAM Nameplate

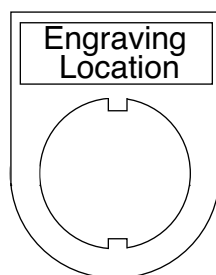

**Step 1.**  
Choose Letter Size - 7/64" or 1/8".  
Check the box for the letter size you want. Then write your lettering in box below the check boxes. Note: 1/8" size letters cannot exceed 9 characters.

7/64" Letter Size  11 characters maximum (for 7/64" size letters)

1/8" Letter Size  9 characters maximum (for 7/8" size letters)

Qty

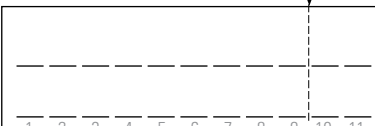

**Step 2.**  
Specify Quantity.  
Enter the number of nameplates desired in the box on the right.

Sample Letter Sizes  
7/64" Letters: A B C D  
1/8" Letters: A B C D

## Dimensions (mm)

### Illuminated Pushbuttons

#### 1 to 3 Contacts

##### Round Flush

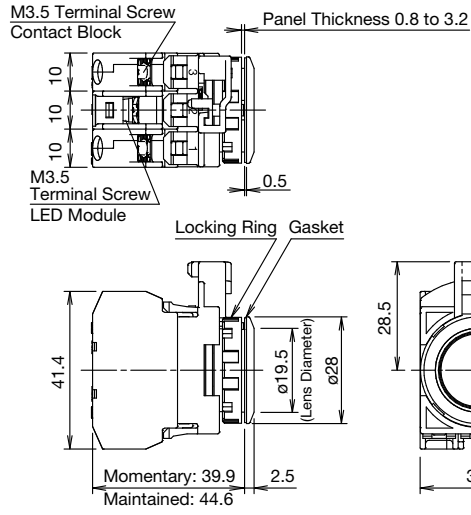

##### Round Extended

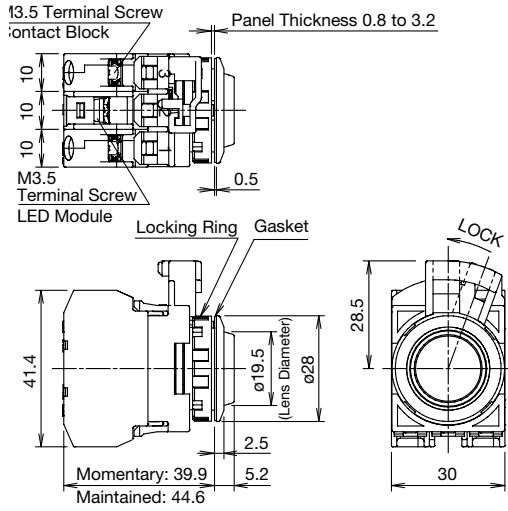

#### 4 to 6 Contacts

##### Round Flush

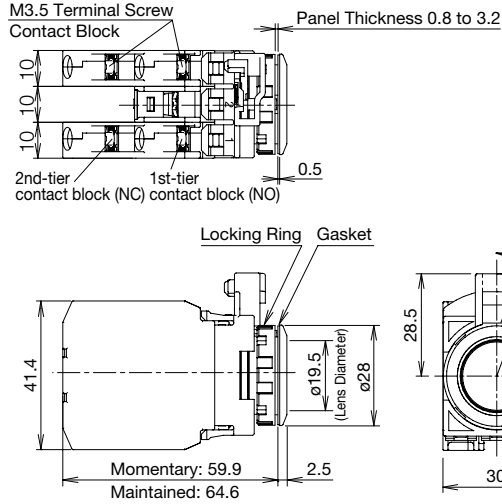

##### Round Extended

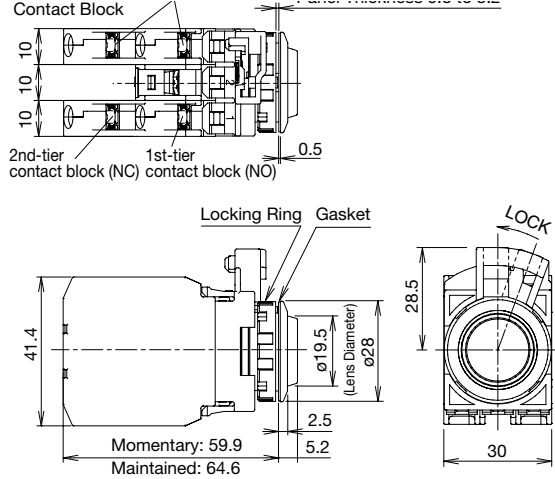



Pushbuttons

1 to 3 Contacts

Round Flush

M3.5 Terminal Screw  
Contact Block

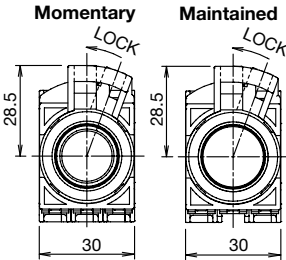
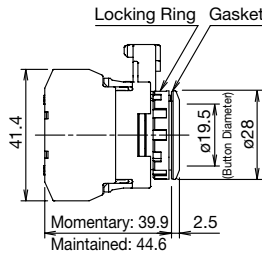
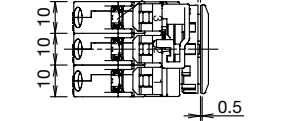

Round Extended

M3.5 Terminal Screw  
Contact Block

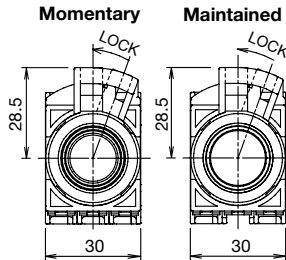
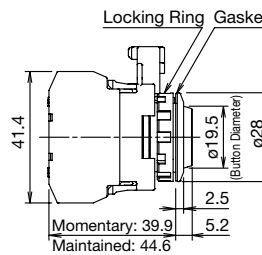
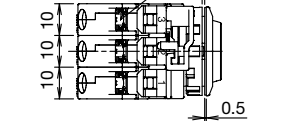

Round Flush

M3.5 Terminal Screw  
Contact Block

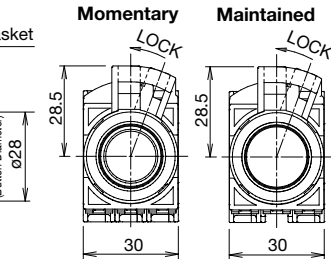
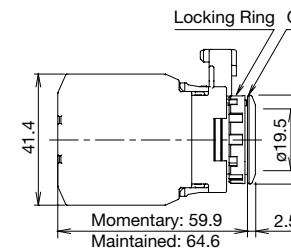
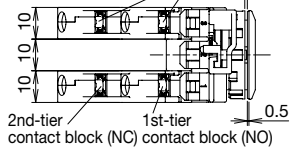

Round Extended

M3.5 Terminal Screw  
Contact Block

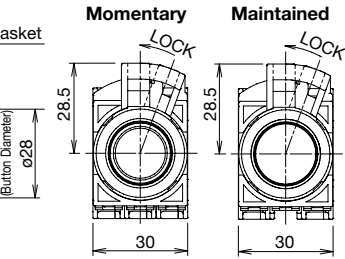
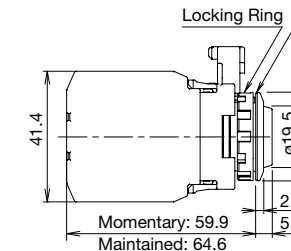
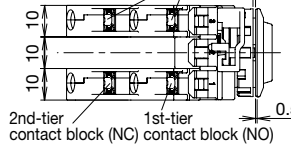

Round Flush

M3.5 Terminal Screw  
LED Module

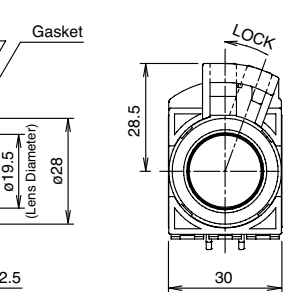
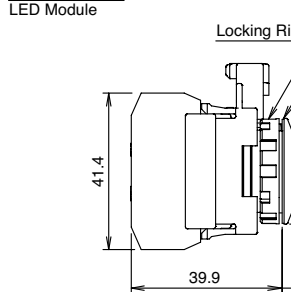
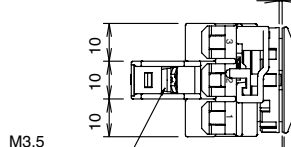

Round Dome

M3.5 Terminal Screw  
LED Module

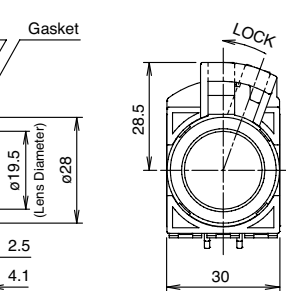
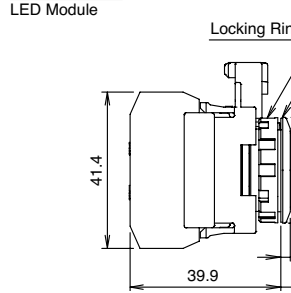
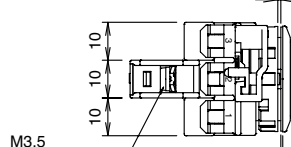

### Selector Switches

#### 1 to 3 Contacts

##### Knob Operator

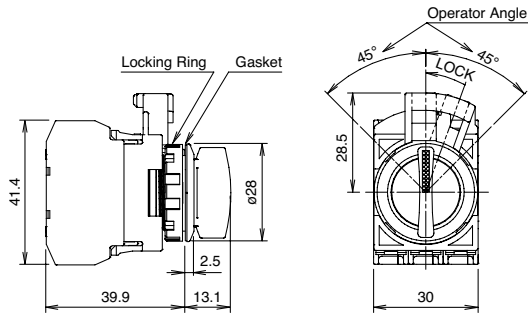
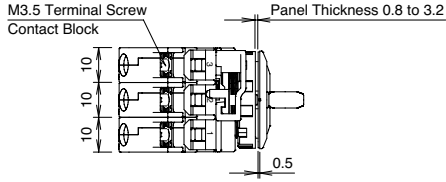

##### Lever Operator

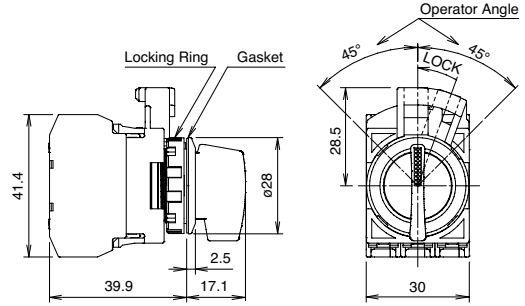
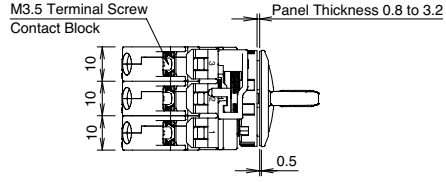

#### 4 to 6 Contacts

##### Knob Operator

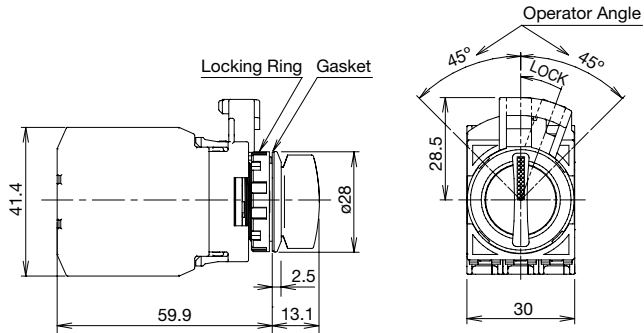
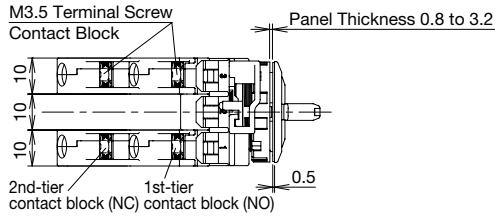

##### Lever Operator

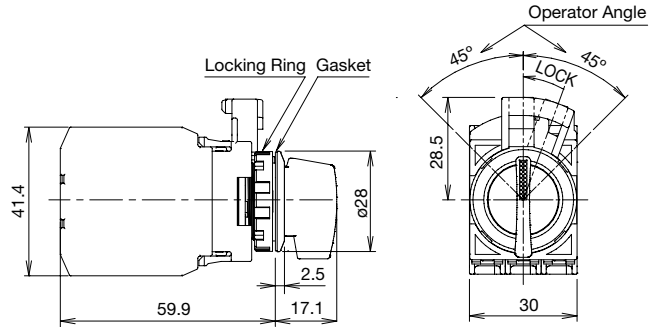
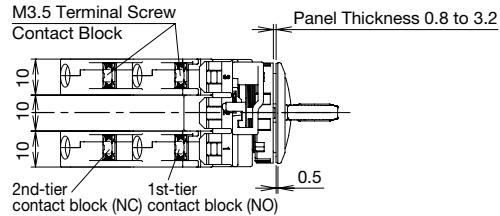

### Key Selector Switches

#### 1 to 3 Contacts

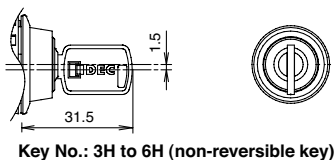
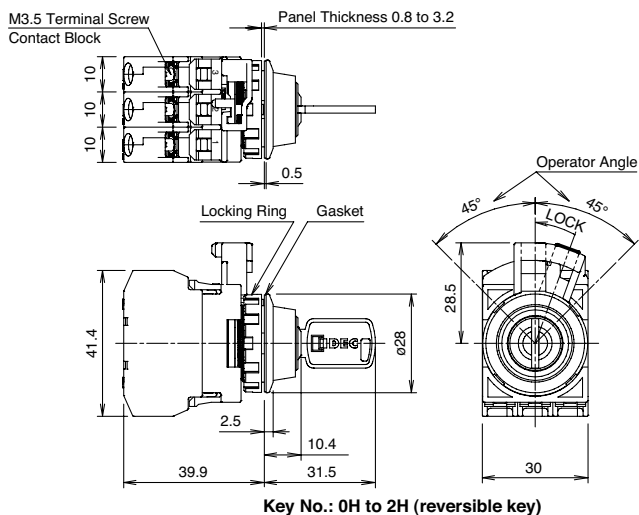

#### Keys

##### Reversible Key

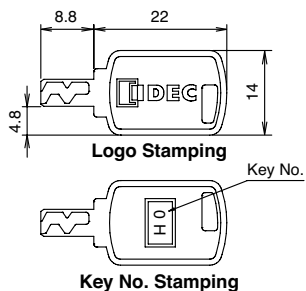

##### Non-reversible Key

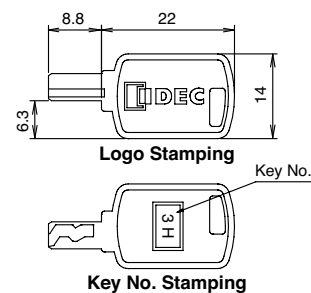

#### 4 to 6 Contacts

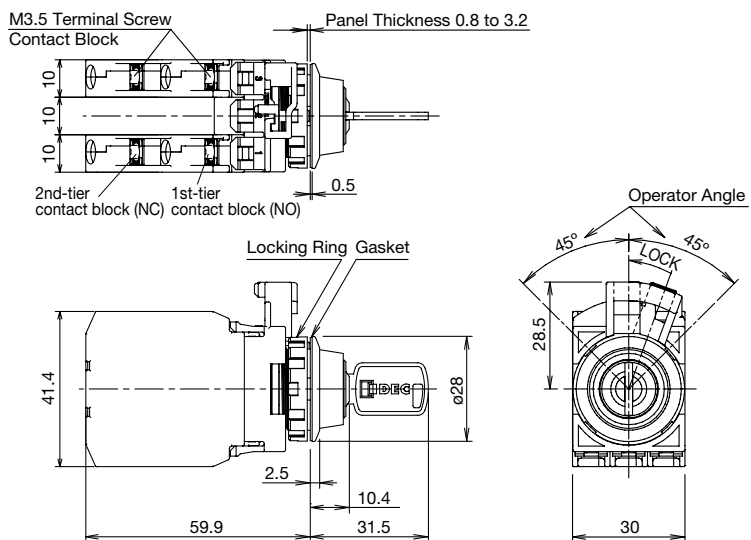

### Safety Precautions

Turn off the power to CW series switches before installation, removal, wiring and maintenance. Failure to turn power off may cause electrical shocks or fire hazard.

When wiring, use wires of a proper size to meet the voltage and current requirements. Tighten the M3.5 terminal screws to a tightening torque of 1.0 to 1.3 N·m. Failure to tighten the terminal screws may cause overheating and fire.

### Operating Instructions

#### Notes for Operation

When using the CW series switches in a safety-related circuit of a control system, observe safety rules and regulations of each country concerning particular applications of the actual machines and facilities. Perform risk assessment before operation to ensure safety.

#### Operating Conditions

In corrosive gas or high-temperature, high-humidity environments, contact failure due to corrosion or color change or breakage of the housing may occur.

Main parts of the CW series switches are made of plastic. Do not scratch the surface with a sharp object or apply excessive electric shock or load, otherwise the switches may be damaged. In particular, keep the button, lens and bezel from such damage, otherwise appearance and function may be impaired.

Do not apply detergents, cutting oils, or chemicals which may impair the function and appearance of the CW series switches.

#### Panel Mounting

First remove the contact block and then the locking ring from the operator. Insert the operator into the panel cut-out from the front, tighten the locking ring from the back, then install the contact block to the operator.

#### Mounting Hole

1. Mounting hole dimensions are in compliance with IEC60947-5-1.
2. If the anti-rotation projection is removed from the bezel, CW series switches can be mounted in ø22.3mm mounting holes. To remove the anti-rotation projection, remove the gasket and use cutting pliers to break the projection.

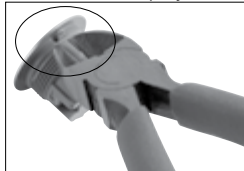

#### Removing and Installing the Contact Unit

1. To remove the contact block from the operator, push the yellow locking lever and turn it to the left.

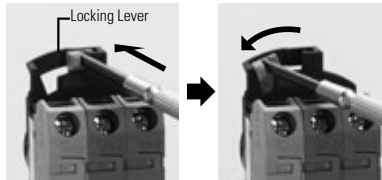

2. To install, align the TOP marking on the operator with the TOP marking on the contact block mounting adaptor, and turn the locking lever to the right.

#### Installation in Panel Cut-out

Remove the locking ring from the operator. With the anti-rotation projection on the operator aligned with the recess in the mounting hole, insert the operator into the mounting hole. Tighten the locking ring from the rear of the panel.

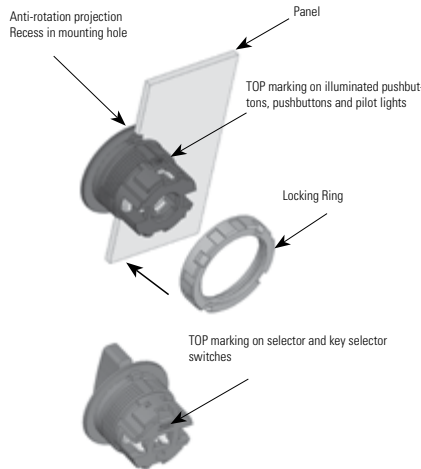

#### Note for Panel Mounting

When installing the operator in a panel cut-out, use the optional locking ring wrench (MW9Z-T1) to tighten the locking ring to a recommended tightening torque of 1.2 N·m. Do not use pliers and do not tighten excessively, otherwise the operator may be damaged.

#### Illuminated Pushbuttons and Pilot Lights

##### Removing the Lens

To remove the lens from an illuminated pushbutton or pilot light, insert a flat screwdriver under the flange of the lens at 90° from the TOP marking and twist the screwdriver.

Do not insert the screwdriver too far and do not apply excessive force to the lens, otherwise the bezel surface may be damaged.

##### Screwdriver Insertion Direction

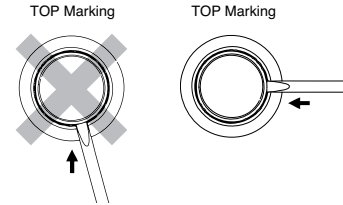

##### Screwdriver Insertion Angle

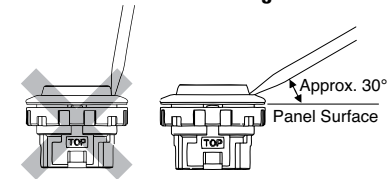

##### Installing the Lens

Turn the groove in the lens to the TOP marking on the operator housing. With the groove aligned with the ridge, press the lens in.

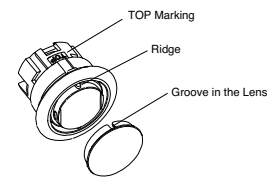

##### Marking

Marking film can be applied for inscriptions or identification.

##### Applicable Marking Film Size

Illuminated Pushbutton (Round Flush) Pilot Light (Round Flush, Round Extended)	Illuminated Pushbutton (Round Extended)

Thickness: 0.2mm maximum  
 Film material: Polyester (recommended)  
 Note: Film is not supplied and must be provided by the user.

**Operating Instructions, con't**

**Pushbuttons**

Pushbutton caps cannot be removed. Do not tamper with the cap using a screwdriver or pliers, otherwise it may be damaged.

**Selector Switches**

Turn the selector operator or key to the detent positions.

**Key Selector Switches**

To prevent malfunction and damage, take the following precautions.

- Completely insert the key before turning.
- Do not remove the key while turning.
- Besides the standard key (0H), six other keys are available. Use only a key with a number that matches the number on the switches' key cylinder. (The standard key does not have a key number.)
- Keys are available in two shapes.  
-0H (standard), 1H, 2H: reversible keys  
-3H, 4H, 5H, 6H: non-reversible keys  
Make sure of correct insertion direction.

**Contact Blocks and LED Modules**

To remove the contact block from the operator, insert a flat screwdriver under the latch and push the screwdriver down as shown below. Before removing the LED module, first remove all contact blocks, and then remove the LED module in the same manner.

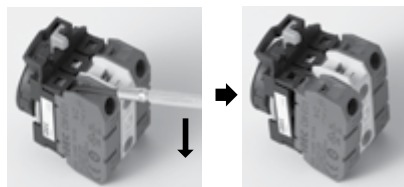

**Wiring**

**Applicable Wires**

Stranded wire: 2.0 mm<sup>2</sup> maximum (14AWG)  
Solid wire: ø1.6 mm maximum

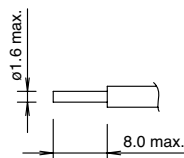

One or two wires can be connected to the terminal.

**Applicable Crimping Terminals**

Spade terminal  
When using crimping terminals, be sure to use insulating tubes or insulated crimping terminals.

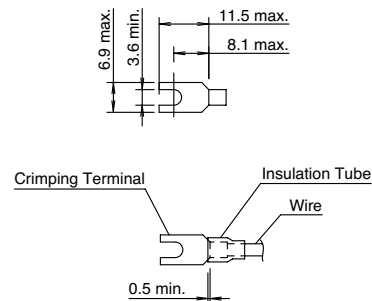

**Ferrule**

When connecting two ferrules to one terminal, use ferrules without insulation.

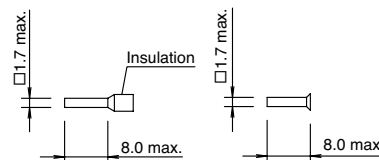

When using spade terminals or ferrules, ensure that they are inserted completely. Ring terminals cannot be used.

**Screw Tightening Torque**

Tighten the M3.5 terminal screws to a recommended torque of 1.0 to 1.3N·m.

**HW Series – 22mm IEC Style Global Pushbuttons**

**Key features:**

- Locking lever removable contact blocks
- Finger-safe IP20 contacts as standard, other terminal styles available
- Tamperproof construction
- All E-stops meet EN418 and are compliant with SEMI S2 standards
- Worldwide approvals
- Easy to assemble
- Choice of black plastic or metallic front bezels
- Incandescent or LED illumination
- Transformer or full voltage
- Slow make double break self cleaning contacts



**HW: The Best Engineered Switch in the World**

IDEC's HW switches are "The best engineered switch in the world" for a reason. Carrying the CE mark, UL, CSA, CCC (Chinese), and TUV approvals, these switches are designed for use in almost any part of the world.

(22mm) switches include illuminated and non-illuminated pushbuttons, pilot lights, selector switches, and emergency stop switches.

Complete with finger-safe contact blocks offering IP20 protection, these 7/8"

All switches also incorporate mechanically keyed safety locking levers, ensuring correct installation and maintaining safety in high-vibration applications.



File No. E68961



File No. LR92374



Registration No. R9551089 (E-stops)  
 Registration No. R50054316 (Dual Pushbuttons)  
 Registration No. J9650511 (Pilot Lights)  
 Registration No. J9551458 (all other switches)



TÜV Rheinland  
 Certificate No.  
 2005010305145656



**Specifications**

Electrical	Rated Operational Characteristics	AC-15: A600 or Ue = 250V, Ie = 3A (NO, NC, NO-EM, NC-LB) DC-13: P600 or Ue = 125V, Ie = 1.1A (NO, NC) DC-13: Q600 or Ue = 125V, Ie = 0.9A (NO-EM, NC-LB)
	Maximum Inrush Current	40 A (40 ms)
	Rated Insulation Voltage	600V
	Rated Switching Over-Voltage	Less than 4kV, conforming to IEC60947-1
	Rated Impulse Withstanding Voltage	4kV for contact circuit, 2.5kV for lamp circuit
	Rated Thermal Current	10 Amp
	Minimum Switching Capacity	5 mA at 3V AC/DC
	Electrical Reliability	MTBF < 1 fault for 10 million operation cycles (3V DC, 5mA)
Mechanical	Lamp Ratings	Incandescent: 1 W LEDs: 6V/17mA max, 12V & 24V/11mA max, 120 & 240V/10mA max
	Contact Operation	Slow break NC or NO, self-cleaning
	Positive Action Operation (Emergency Stops with NC contacts)	5.5mm to 10mm travel to latch, 45N minimum force to latch 10mm maximum travel, 1,800 operations per hour maximum for a Pushlock Turn Reset 900 operations per hour maximum for a Push-Pull
	Operating Force	Flush and extended pushbuttons—with 1NO or 1NC contact: 6.2±2N (momentary), 7.0±2N (maintained) Additional contacts—1NO or 1NC: +3.2N (momentary), + 3.3N (maintained)
	Recommended Terminal Torque	0.8 N m (7.1 in lb.)
	Applicable Wire Size	Minimum 1 x 22 AWG, max. 2 x 14 AWG or 1 x 12 AWG
	Contact Resistance	Initial contact resistance of 50mΩ or less
	Contact Gap	4mm (NO and NC), 2mm (NO-EM and NC-LB)
	Horsepower Rating	Reference Value: 1/4 HP @ 120V (1Ø non-reversing), 1HP @ 240V (3Ø non-reversing)
	Contact Material	Silver (gold plated contacts available - contact IDEC)
	Operating Temperature	Operation: -25 to +50°C (without freezing), Storage: -40 to +70°C (without freezing)
Vibration Resistance	10 to 55Hz, 98m/sec <sup>2</sup> (10G) conforming to IEC6068-2-6	
Shock Resistance	980m/sec <sup>2</sup> (100G) conforming to IEC6068-2-7	
Mechanical Life	Momentary pushbuttons: 5,000,000 (900 operations per hour), All other switches: 500,000	

Switches & Pilot Devices

Signaling Lights





Relays & Sockets

Timers

Contactors





Terminal Blocks

Circuit Breakers

Conforming to Standards		EN60947-1, EN60947-5-1, VDE0660-200, UL508, CSA C22-2 No.14							
Standards & Approvals	Approvals		CSA: pushbuttons and selector switches: A600 pilot lights and illuminated pushbuttons, direct supply pilot lights and illuminated pushbuttons with integral transformer (100/110, 115, 120, 200/220, 230, 240, 380, 400/440, 480V) UL: pushbuttons and selector switches: A600 pilot lights and illuminated pushbuttons, direct supply pilot lights and illuminated pushbuttons with integral transformer (100/110, 115, 120, 200/220, 230, 240, 380, 400/440, 480V) TÜV: pushbuttons and selector switches: A600=P600 (NO, NC)/Q600 (NO-EM, NC-LB) pilot lights and illuminated pushbuttons, direct supply pilot lights and illuminated pushbuttons with integral transformer (100/110, 115, 120, 200/220, 230, 240, 380, 400/440, 480V)						
	 File No. E68961  File No. LR92374   Registration No. R9551089 (E-stops) Registration No. R50054316 (Dual Pushbuttons) Registration No. J9650511 (Pilot Lights) Registration No. J9551458 (all other switches)		 TÜV Rheinland Certificate No. 2005010305145656						
	Electric Shock Protection		Class 0 conforming to IEC60536						
	Degree of Protection (conforming to IEC60529)		IP65 (from front of the panel) IP20 (Type HW-F contact block)						
	Pollution Degree (conforming to IEC60947-1)		3 for switches not using a transformer, 2 for switches using a transformer						
	External Short-Circuit Protection		10A 250V fuse conforming to IEC60269-1						
Terminal Referencing		Conforming to CENELEC EN50005							
Contact Ratings	Pushbuttons		Contact Block		Type HW-C/HW-F /HW-G				
	Illuminated Pushbuttons		Rated Insulation Voltage		600V				
	Selector Switches		Rated Continuous Current		10A				
	Illuminated Selector Switches		Contact Ratings by Utilization Category		AC-15 (A600) DC-13 (P600)				
	Pushbutton Selectors		IEC 60947-5-1						
Characteristics	Operational Voltage		24V	48V	50V	110V	220V	440V	
	Operational Current	AC 50/60 Hz	AC-12 Control of resistive loads & solid state loads	10A	—	10A	10A	6A	2A
			AC-15 Control of electromagnetic loads (> 72VA)	10A	—	7A	5A	3A	1A
		DC	DC-12 Control of resistive loads & solid state loads	8A	5A	—	2.2A	1.1A	—
			DC-13 Control of electromagnets	5A	2A	—	1.1A	0.6A	—

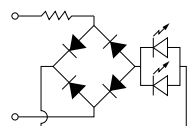
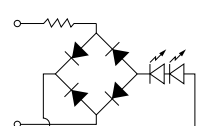
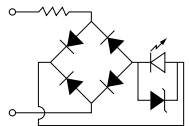
 For dimensions, see page 651.

### LED Lamp Ratings (LSTD Type)

Model	LSTD-6Ⓜ	LSTD-1Ⓜ	LSTD-2Ⓜ	LSTD-H2Ⓜ	LSTD-M4Ⓜ
Lamp Base	BA9S/13				
Rated Voltage	6V AC/DC	12V AC/DC	24V AC/DC	120V AC	240V AC
Voltage Range	6V AC/DC ±10%	12V AC/DC ±10%	24V AC/DC ±10%	120V AC ±5%	240V AC ±5%
Current Draw	AC A, R, W: G, S:	17mA 8mA	11mA	11mA	10mA
	DC A, R, W: G, S:	14mA 5.5mA	10mA	10mA	—
Color Code	A (amber), G (green), R (red), S (blue), W (white)				
Lamp Base Color	Same as illumination color				
Voltage Marking	Die stamped on the base				
Life (reference value)	Approx. 50,000 hours (The luminance reduces to 50% the initial intensity when used on complete DC.)				
Internal Circuit	A, R, W		A, R, W		
					
	G, S				
		<ul style="list-style-type: none"> <li> LED Chip</li> <li> Protection Diode</li> <li> Zener Diode</li> </ul>			

 In place of Ⓜ, specify the Lens/LSD Color Code.



**Non-Illuminated Round Pushbuttons (Assembled)**



Function	Contacts	Round Flush		Round Extended	
		Plastic Bezel	Metal Bezel	Plastic Bezel	Metal Bezel
Momentary	Operator Only	<i>HW1B-M1-①</i>	<i>HW4B-M1-①</i>	<i>HW1B-M2-①</i>	<i>HW4B-M2-①</i>
	1NO	HW1B-M1F10-①	HW4B-M1F10-①	HW1B-M2F10-①	HW4B-M2F10-①
	1NC	HW1B-M1F01-①	HW4B-M1F01-①	HW1B-M2F01-①	HW4B-M2F01-①
	1NO-1NC	HW1B-M1F11-①	HW4B-M1F11-①	HW1B-M2F11-①	HW4B-M2F11-①
	2NO	HW1B-M1F20-①	HW4B-M1F20-①	HW1B-M2F20-①	HW4B-M2F20-①
	2NC	HW1B-M1F02-①	HW4B-M1F02-①	HW1B-M2F02-①	HW4B-M2F02-①
	2NO-2NC	HW1B-M1F22-①	HW4B-M1F22-①	HW1B-M2F22-①	HW4B-M2F22-①
Maintained	Operator Only	<i>HW1B-A1-①</i>	<i>HW4B-A1-①</i>	<i>HW1B-A2-①</i>	<i>HW4B-A2-①</i>
	1NO	HW1B-A1F10-①	HW4B-A1F10-①	HW1B-A2F10-①	HW4B-A2F10-①
	1NC	HW1B-A1F01-①	HW4B-A1F01-①	HW1B-A2F01-①	HW4B-A2F01-①
	1NO-1NC	HW1B-A1F11-①	HW4B-A1F11-①	HW1B-A2F11-①	HW4B-A2F11-①
	2NO	HW1B-A1F20-①	HW4B-A1F20-①	HW1B-A2F20-①	HW4B-A2F20-①
	2NC	HW1B-A1F02-①	HW4B-A1F02-①	HW1B-A2F02-①	HW4B-A2F02-①
	2NO-2NC	HW1B-A1F22-①	HW4B-A1F22-①	HW1B-A2F22-①	HW4B-A2F22-①

**① Button Color Code**

Color	Code
Black	B
Green	G
Red	R
Blue	S
White	W
Yellow	Y



1. In place of ①, specify the Button Color Code from table below.
2. For nameplates and accessories, see page 646 and 649.
3. For dimensions, see page 651.
4. For contact assembly part numbers, see page 650.
5. All assembled part numbers in catalog include standard, fingersafe (HW-F...) contacts.
6. Assembled units with spring-up terminals (HW-G...) can be ordered by removing an "F" from the part number (Ex. HW1B-M1F11-R becomes HW1B-M111-R).
7. Operator only models include operator plus button.
8. Additional contact configurations available (up to 6 total contacts).



Part Number Structure

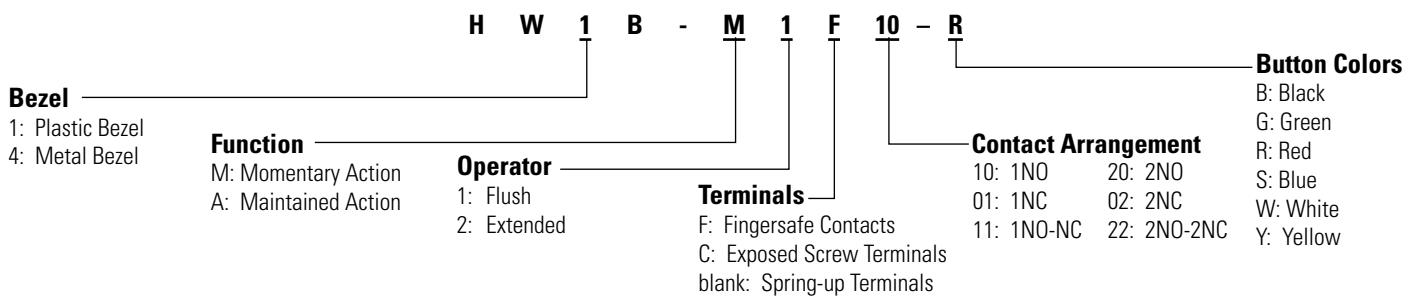

Non-Illuminated Round Pushbuttons (Replacement Parts)

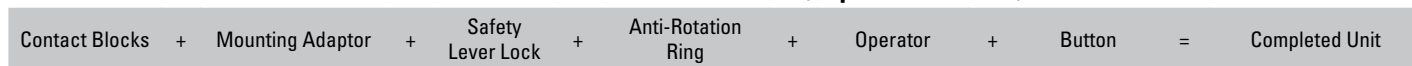

Contact Blocks

Style	Contacts	1NO	1NC
	Standard Fingersafe (IP20)	HW-F10	HW-F01
		HW-F10R (early make)	HW-F01R (late break)
	Spring-Up Terminal	HW-G10	HW-G01
		HW-G10R (early make)	HW-G01R (late break)
	Exposed Screw Terminal	HW-C10	HW-C01
		HW-C10R (early make)	HW-C01R (late break)
	Dummy Block	TW-DB	

Contact Block Mounting Adaptor

Style	Part Number
	HW-CB2C

- 1. Used to mount contact blocks to operator.
- 2. IDEC strongly recommends using the safety lever lock to prevent heavy vibration or maintenance personnel from inadvertently unlocking contacts.

Anti-Rotation Ring

Style	Part Number
	HW9Z-RL

Use with notched panel cutout to prevent unit rotation.

Operators

Style	Plastic Bezel	Metal Bezel
	Momentary	HW1B-M0 HW4B-M0
	Maintained	HW1B-A0 HW4B-A0

Safety Lever Lock

Style	Part Number
	HW9Z-LS

Buttons

Style	Part Number
Round Flush 	HW1A-B1-Ⓢ
Round Extended 	HW1A-B2-Ⓢ

1. In place of Ⓢ, specify the Button Color Code from table.

Ⓢ Button Color Code

Color	Code
Black	B
Green	G
Red	R
Blue	S
White	W
Yellow	Y

Non-Illuminated Mushroom Head Pushbuttons (Assembled)



Function	Contacts	ø29mm Mushroom Head		ø40mm Mushroom Head	
		Plastic Bezel	Metal Bezel	Plastic Bezel	Metal Bezel
Momentary	<i>Operator Only</i>	<b>HW1B-M3-①</b>	<b>HW4B-M3-①</b>	<b>HW1B-M4-①</b>	<b>HW4B-M4-①</b>
	1NO	HW1B-M3F10-①	HW4B-M3F10-①	HW1B-M4F10-①	HW4B-M4F10-①
	1NC	HW1B-M3F01-①	HW4B-M3F01-①	HW1B-M4F01-①	HW4B-M4F01-①
	1NO-1NC	HW1B-M3F11-①	HW4B-M3F11-①	HW1B-M4F11-①	HW4B-M4F11-①
	2NO	HW1B-M3F20-①	HW4B-M3F20-①	HW1B-M4F20-①	HW4B-M4F20-①
	2NC	HW1B-M3F02-①	HW4B-M3F02-①	HW1B-M4F02-①	HW4B-M4F02-①
	2NO-2NC	HW1B-M3F22-①	HW4B-M3F22-①	HW1B-M4F22-①	HW4B-M4F22-①
Maintained	<i>Operator Only</i>	<b>HW1B-A3-①</b>	<b>HW4B-A3-①</b>	<b>HW1B-A4-①</b>	<b>HW4B-A4-①</b>
	1NO	HW1B-A3F10-①	HW4B-A3F10-①	HW1B-A4F10-①	HW4B-A4F10-①
	1NC	HW1B-A3F01-①	HW4B-A3F01-①	HW1B-A4F01-①	HW4B-A4F01-①
	1NO-1NC	HW1B-A3F11-①	HW4B-A3F11-①	HW1B-A4F11-①	HW4B-A4F11-①
	2NO	HW1B-A3F20-①	HW4B-A3F20-①	HW1B-A4F20-①	HW4B-A4F20-①
	2NC	HW1B-A3F02-①	HW4B-A3F02-①	HW1B-A4F02-①	HW4B-A4F02-①
	2NO-2NC	HW1B-A3F22-①	HW4B-A3F22-①	HW1B-A4F22-①	HW4B-A4F22-①



① Button Color Code

Color	Code
Black	B
Green	G
Red	R
Blue	S
White	W
Yellow	Y



1. In place of ①, specify the Button Color Code from table.
2. \*60mm mushroom available only in red, green, black, and yellow.
3. For nameplates and accessories, see page 646 and 649.
4. For dimensions, see page 651.
5. For contact assembly part numbers, see page 650.
6. All assembled part numbers in catalog include standard fingersafe (HW-F...) contacts.
7. Assembled units with spring-up terminals (HW-G...) can be ordered by removing an "F" from the part number (Ex. HW1B-M1F11-R becomes HW1B-M111-R).
8. Units with exposed screw terminals (HW-C...) must be ordered as sub-components.
9. Operator only models include operator plus button.
10. Additional contact configurations available (up to 6 total contacts).

Function	Contacts	ø60mm Mushroom Head
		Plastic Bezel
Momentary	<i>Operator Only</i>	<b>HW1B-M5-①*</b>
	1NO	HW1B-M5F10-①*
	1NC	HW1B-M5F01-①*
	1NO-1NC	HW1B-M5F11-①*
	2NO	HW1B-M5F20-①*
	2NC	HW1B-M5F02-①*
	2NO-2NC	HW1B-M5F22-①*

Part Number Structure

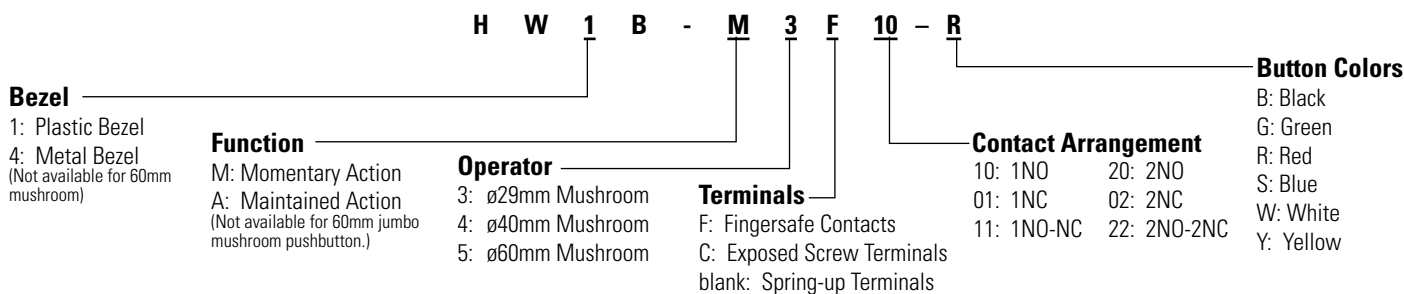

Non-Illuminated Mushroom Head Pushbuttons (Replacement Parts)

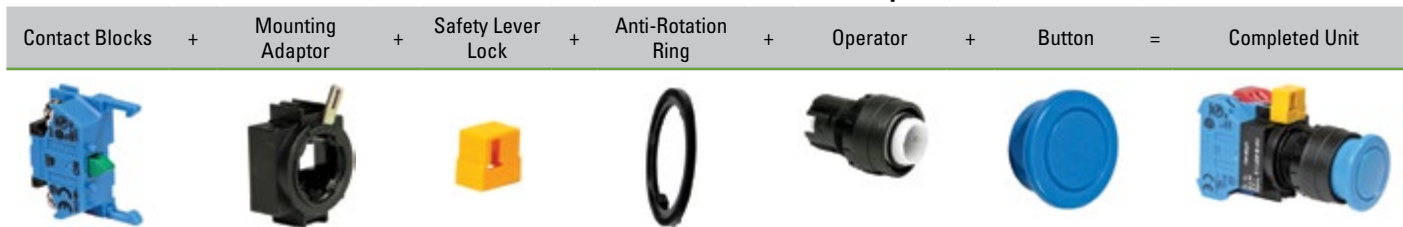

Contact Blocks

Style	Contacts	1NO	1NC
	Standard Fingersafe (IP20)	HW-F10	HW-F01
		HW-F10R (early make)	HW-F01R (late break)
	Spring-Up Terminal	HW-G10	HW-G01
		HW-G10R (early make)	HW-G01R (late break)
	Exposed Screw Terminal	HW-C10	HW-C01
		HW-C10R (early make)	HW-C01R (late break)
	Dummy Block	TW-DB	

Contact Block Mounting Adaptor

Style	Part Number
	HW-CB2C

- 1. Used to mount contact blocks to operator.
- 2. IDEC strongly recommends using the safety lever lock to prevent heavy vibration or maintenance personnel from inadvertently unlocking contacts.

Safety Lever Lock

Style	Part Number
	HW9Z-LS

Anti-Rotation Ring

Appearance	Part Number
	HW9Z-RL

Operators

Style		Plastic Bezel	Metal Bezel
ø29mm Mushroom ø40mm Mushroom	Momentary	HW1B-MOL	HW4B-MOL
	Maintained	HW1B-AOL	HW4B-AOL
Ø60mm Jumbo Mushroom	Momentary	HW1B-M5-⊙*	-

- 1. \*60mm mushroom operator includes non-removable button (available in red, black, green and yellow).
- 2. For nameplates and accessories, see page 646 and 649.
- 3. For dimensions, see page 651.

Buttons

Style	Part Number
ø29mm Mushroom Cap	HW1A-B3-⊙
ø40mm Mushroom Cap	HW1A-B4-⊙

- 1. In place of ⊙, specify the Button Color Code from table.

⊙ Button Color Code

Color	Code	Color	Code
Black	B	Blue	S
Green	G	White	W
Red	R	Yellow	Y

- HW1B-M5 available only in black, red, green and yellow.

**Non-Illuminated Square Pushbuttons (Assembled)**



Function	Contacts	Square Flush	Square Extended
		Plastic Bezel	Plastic Bezel
Momentary	<i>Operator Only</i>	<b>HW2B-M1-①</b>	<b>HW2B-M2-①</b>
	1NO	HW2B-M1F10-①	HW2B-M2F10-①
	1NC	HW2B-M1F01-①	HW2B-M2F01-①
	1NO-1NC	HW2B-M1F11-①	HW2B-M2F11-①
	2NO	HW2B-M1F20-①	HW2B-M2F20-①
	2NC	HW2B-M1F02-①	HW2B-M2F02-①
	2NO-2NC	HW2B-M1F22-①	HW2B-M2F22-①
Maintained	<i>Operator Only</i>	<b>HW2B-A1-①</b>	<b>HW2B-A2-①</b>
	1NO	HW2B-A1F10-①	HW2B-A2F10-①
	1NC	HW2B-A1F01-①	HW2B-A2F01-①
	1NO-1NC	HW2B-A1F11-①	HW2B-A2F11-①
	2NO	HW2B-A1F20-①	HW2B-A2F20-①
	2NC	HW2B-A1F02-①	HW2B-A2F02-①
	2NO-2NC	HW2B-A1F22-①	HW2B-A2F22-①

**① Button Color Code**

Color	Code
Black	B
Green	G
Red	R
Blue	S
White	W
Yellow	Y



1. In place of ①, specify the Button Color Code from table.
2. For nameplates and accessories, see page 646 and 649.
3. For dimensions, see page 651.
4. For contact assembly part numbers, see page 650.
5. Square pushbuttons available in plastic bezel only.
6. All assembled part numbers in catalog include standard fingersafe (HW-F...) contacts.
7. Assembled units with spring-up terminals (HW-G...) can be ordered by removing an "F" from the part number (Ex. HW2B-M1F11-R becomes HW1B-M111-R).
8. Units with exposed screw terminals (HW-C...) must be ordered as sub-components.
9. Operator only model includes operator and button.
10. Additional contact configurations available (up to 6 total contacts).

Part Number Structure

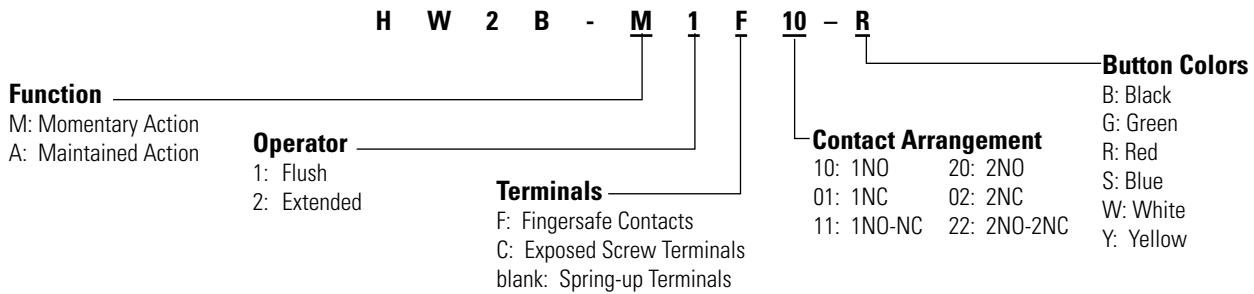

Non-Illuminated Square Pushbuttons (Replacement Parts)

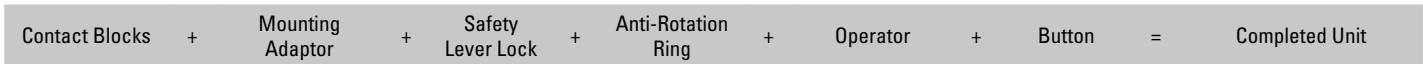

Contact Blocks

Style	Contacts	1NO	1NC
	Standard Fingersafe (IP20)	HW-F10	HW-F01
		HW-F10R (early make)	HW-F01R (late break)
	Spring-Up Terminal	HW-G10	HW-G01
		HW-G10R (early make)	HW-G01R (late break)
	Exposed Screw Terminal	HW-C10	HW-C01
		HW-C10R (early make)	HW-C01R (late break)
	Dummy Block	TW-DB	

Contact Block Mounting Adaptor

Style	Part Number
	HW-CB2C

- 1. Used to mount contact blocks to operator.
- 2. IDEC strongly recommends using the safety lever lock to prevent heavy vibration or maintenance personnel from inadvertently unlocking contacts.

Safety Lever Lock

Style	Part Number
	HW9Z-LS

Anti-Rotation Ring

Appearance	Part Number
	HW9Z-RL

- Use with notched panel cutout to prevent unit rotation.

Operators

Style	Plastic Bezel
Square Flush Extended 	Momentary HW2B-M0
	Maintained HW2B-A0

- 2. For nameplates and accessories, see pages 646 and 649.
- 3. For dimensions, see page 651.

Buttons

Style	Part Number
Square Flush 	HW2A-B1-Ⓢ
Square Extended 	
	HW2A-B2-Ⓢ

- 1. In place of Ⓢ, specify the Button Color Code from table.

Ⓢ Button Color Code

Color	Code	Color	Code
Black	B	Blue	S
Green	G	White	W
Red	R	Yellow	Y

**Non-Illuminated E-Stop Pushbuttons (Assembled)**



Contacts	Ø29mm Head Pushlock Turn Reset		Ø40mm Head Pushlock Turn Reset	
	Plastic Bezel	Metal Bezel	Plastic Bezel	Metal Bezel
<i>Operator Only</i>	<i>HW1B-V3</i> Ⓞ†	<i>HW4B-V3</i> Ⓞ†	<i>HW1B-V4</i> Ⓞ†	<i>HW4B-V4</i> Ⓞ†
1NO	HW1B-V3F10-Ⓞ†	HW4B-V3F10-Ⓞ†	HW1B-V4F10-Ⓞ†	HW4B-V4F10-Ⓞ†
1NC	HW1B-V3F01-Ⓞ†	HW4B-V3F01-Ⓞ†	HW1B-V4F01-Ⓞ†	HW4B-V4F01-Ⓞ†
1NO-1NC	HW1B-V3F11-Ⓞ†	HW4B-V3F11-Ⓞ†	HW1B-V4F11-Ⓞ†	HW4B-V4F11-Ⓞ†
2NO	HW1B-V3F20-Ⓞ†	HW4B-V3F20-Ⓞ†	HW1B-V4F20-Ⓞ†	HW4B-V4F20-Ⓞ†
2NC	HW1B-V3F02-Ⓞ†	HW4B-V3F02-Ⓞ†	HW1B-V4F02-Ⓞ†	HW4B-V4F02-Ⓞ†



Contacts	Ø40mm Head EMO Pushlock Turn Reset		Ø40mm Head Pushlock Key Reset	
	Plastic Bezel	Metal Bezel	Plastic Bezel	Metal Bezel
<i>Operator Only</i>	<i>HW1B-V4R-EMO-2</i> *	<i>HW4B-V4R-EMO-2</i> *	<i>HW1B-X4R</i> *	<i>HW4B-X4R</i> *
1NO	HW1B-V4F10-R-EMO-2*	HW4B-V4F10-R-EMO-2*	HW1B-X4F10-R*	HW4B-X4F10-R*
1NC	HW1B-V4F01-R-EMO-2*	HW4B-V4F01-R-EMO-2*	HW1B-X4F01-R*	HW4B-X4F01-R*
1NO-1NC	HW1B-V4F11-R-EMO-2*	HW4B-V4F11-R-EMO-2*	HW1B-X4F11-R*	HW4B-X4F11-R*
2NO	HW1B-V4F20-R-EMO-2*	HW4B-V4F20-R-EMO-2*	HW1B-X4F20-R*	HW4B-X4F20-R*
2NC	HW1B-V4F02-R-EMO-2*	HW4B-V4F02-R-EMO-2*	HW1B-X4F02-R*	HW4B-X4F02-R*



- \* Available in Red only.
- † Available in red or yellow. Insert color code in place of Ⓞ (R: Red, Y: Yellow).
- For accessories, see page 649.
- For dimensions, see page 651.
- For nameplates and shrouds, see page 650.
- For contact assembly part numbers, see page 650.
- All HW series E-stops comply with EN60947-5-5, the IEC "E-Stop Addendum to the Low Voltage Directive," this includes "tamper proof" operation whereby a change of contact state is not possible by "teasing" or "floating" the operator.
- All assembled part numbers in catalog include standard fingersafe (HW-F...) contacts.
- Assembled units with spring-up terminals (HW-G...) can be ordered by removing an "F" from the part number (Ex. HW1B-M1F11-R becomes HW1B-M111-R).
- Units with exposed screw terminals (HW-C...) must be ordered as sub-components.
- Operator only models include operator and button.
- Additional contact configurations available (up to 6 total contacts).

ø60mm Head Pushlock Turn Reset	
Contacts	Plastic Bezel
<i>Operator Only</i>	<i>HW1B-V5R</i> *
1NO	HW1B-V5F10-R*
1NC	HW1B-V5F01-R*
1NO-1NC	HW1B-V5F11-R*
2NO	HW1B-V5F20-R*
2NC	HW1B-V5F02-R*



Part Number Structure

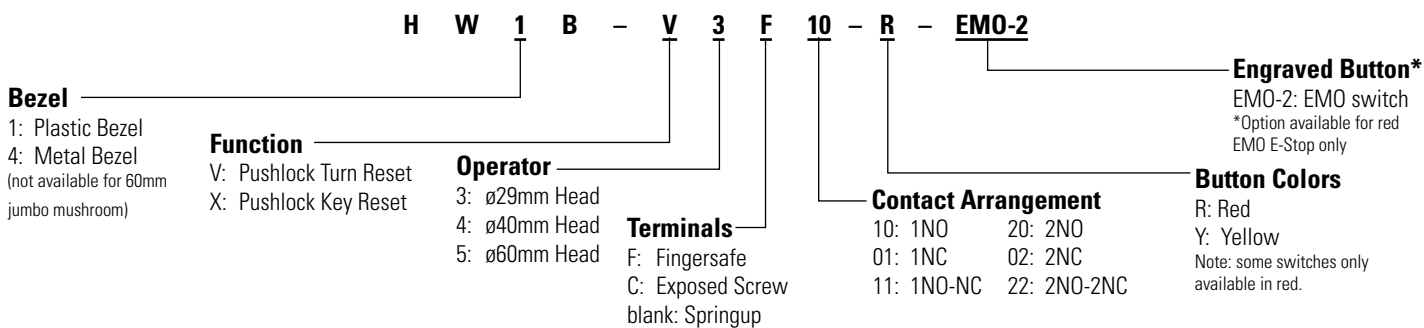

Non-Illuminated E-Stop Pushbuttons (Replacement Parts)

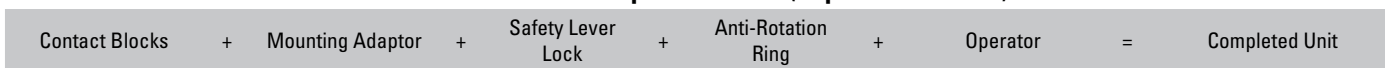

Contact Blocks

Style	Contacts	1NO	1NC
	Standard Fingersafe (IP20)	HW-F10	HW-F01
		HW-F10R (early make)	HW-F01R (late break)

Safety Lever Lock

Style	Part Number
	HW9Z-LS

Anti-Rotation Ring

Appearance	Part Number
	HW9Z-RL

Use with notched panel cutout to prevent unit rotation.

Contact Blocks

	Spring-Up Terminal	HW-G10	HW-G01
		HW-G10R (early make)	HW-G01R (late break)
	Exposed Screw Terminal	HW-C10	HW-C01
		HW-C10R (early make)	HW-C01R (late break)

Operators

Style	Plastic		Metal
ø29mm Head Pushlock Turn Reset 	red	HW1B-V3R	HW4B-V3R
	yellow	HW1B-V3Y	HW4B-V3Y
ø40mm Head Pushlock Turn Reset 	red	HW1B-V4R	HW4B-V4R
	yellow	HW1B-V4Y	HW4B-V4Y
ø40mm Head EMO Pushlock Turn Reset* 		HW1B-V4R-EMO-2	HW4B-V4R-EMO-2
ø40mm Head Pushlock Key Reset* 		HW1B-X4R	HW4B-X4R
ø60mm Head Pushlock Turn Reset* 		HW1B-V5R	-



Dummy Block	TW-DB
-------------	-------

Contact Block Mounting Adaptor

Style	Part Number
	HW-CB2C

- 1. Used to mount contact blocks to operator.
- 2. IDEC strongly recommends using the safety lever lock to prevent heavy vibration or maintenance personnel from inadvertently unlocking contacts.

- 1. \* Available in red only.
- 2. All E-Stop buttons are not removable from the operator.

Note: Determine mounting centers to ensure proper spacing.



Push Pull & Unibody E-Stop Pushbuttons (Assembled)



Contacts	ø40mm Head Push-Pull	
	Plastic Bezel	Metal Bezel
<i>Operator Only (Red)</i>	<i>HW1B-Y2R</i>	<i>HW4B-Y2R</i>
<i>Operator Only (Yellow)</i>	<i>HW1B-Y2Y</i>	<i>HW4B-Y2Y</i>
1NO	HW1B-Y2F10-ⓐ†	HW4B-Y2F10-ⓐ†
1NC	HW1B-Y2F01-ⓐ†	HW4B-Y2F01-ⓐ†
1NO-1NC	HW1B-Y2F11-ⓐ†	HW4B-Y2F11-ⓐ†
2NC	HW1B-Y2F02-ⓐ†	HW4B-Y2F02-ⓐ†
2NO	HW1B-Y2F20-ⓐ†	HW4B-Y2F20-ⓐ†

Contacts	ø40mm Unibody Pushlock Turn Reset*
	Plastic Bezel
1NO-1NC	HW1E-BV4F11-R
2NC	HW1E-BV4F02-R
1NO-2NC	HW1E-BV412R-TK2093-1



Contacts	Unibody Illuminated E-Stops*	
	LED	Incandescent
1NO-1NC	HW1E-LV4F11QD-R-ⓐ	HW1E-LV4F11Q-R-ⓐ
2NC	HW1E-LV4F02QD-R-ⓐ	HW1E-LV4F02Q-R-ⓐ
2NC (with push-on illumination)	HW1E-TV4F02QD-R-ⓐ	HW1E-TV4F11Q-R-ⓐ
1NO-1NC (with push-on illumination)	HW1E-TV4F11QD-R-ⓐ	HW1E-TV4F02Q-R-ⓐ

ⓐ Full Voltage Code

Voltage	Code
6VAC/DC	6V
12VAC/DC	12V
24VAC/DC	24V
120V AC*	120V
240V AC*	240V

Terminal Numbering

(Unibody only)

Models	Terminal Number
1NO-1NC	NO = 13/14, NC = 11/12
2NC	NC = 11/12, NC = 21/22
HW1E-L HW1E-T	Lamp + = X2, Lamp - = X1



\*LED only.



- \* Available in Red only.
- † Available in red or yellow. Insert color code in place of ⓐ (R: Red, Y: Yellow).
- In place of ⓐ, specify Full Voltage Code.
- With single unit construction, the positive action contacts are integrated in the body of the switch. This provides an extra degree of safety and reliability for critical emergency stop functions.
- In the illuminated version, the light is independent of the switch action (except push-on LED model).
- For accessories, see page 649.
- For dimensions, see page 651.
- For nameplates and shrouds, see page 649.
- For contact assembly part numbers, see page 649.
- All HW Series E-Stop operators include non-removable color caps.
- All HW series E-Stops comply with EN60947-5-5, the IEC "E-Stop Addendum to the Low Voltage Directive," this includes "tamper proof" operation whereby a change of contact state is not possible by "teasing" or "floating" the operator.
- All HW series E-Stop switches comply with SEMI S2 standards.
- All assembled part numbers in catalog include standard fingersafe (HW-F...) contacts.
- Assembled units with spring-up terminals (HW-G...) can be ordered by removing an "F" from the part number (Ex. HW1B-M1F11-R becomes HW1B-M111-R).
- Units with exposed screw terminals (HW-C...) must be ordered as sub-components.
- Additional contact configurations available (up to 6 total contacts).

Switches & Pilot Devices

Signaling Lights

Relays & Sockets

Timers

Contactors

Terminal Blocks

Circuit Breakers

Part Number Structure

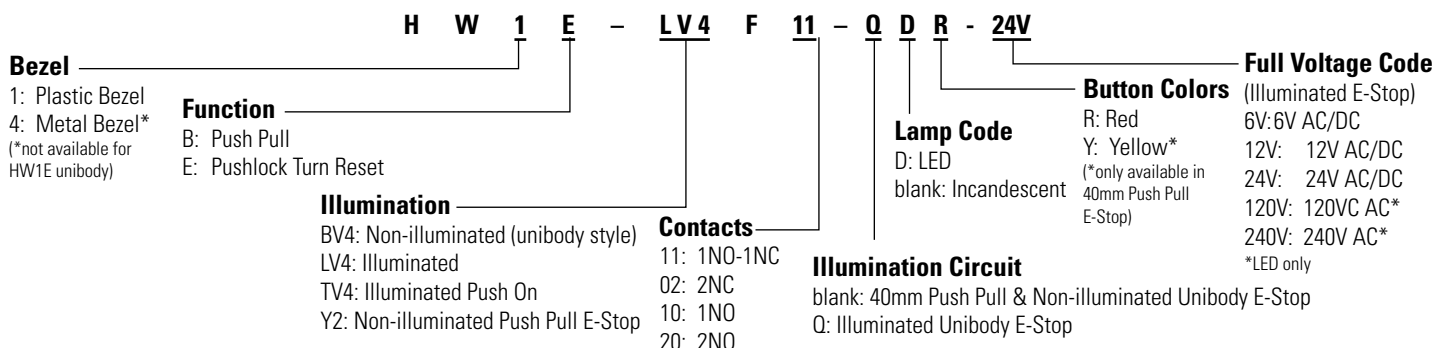

Illuminated & Non-Illuminated E-Stop Pushbuttons (Replacement Parts)

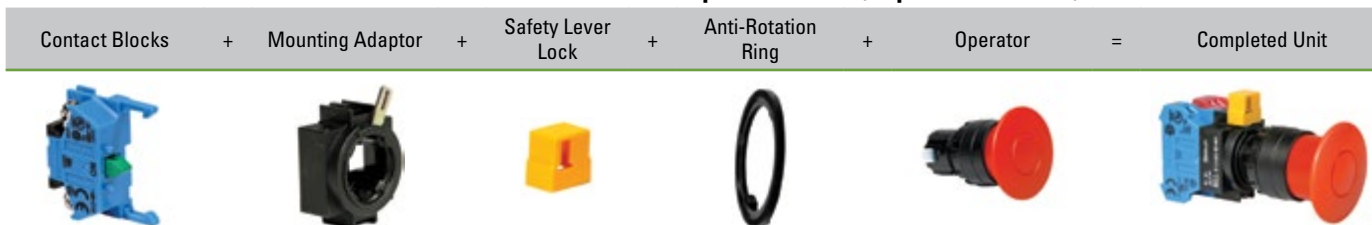

Contact Blocks

Style	Contacts	1NO	1NC
	Standard Fingersafe (IP20)	HW-F10	HW-F01
		HW-F10R (early make)	HW-F01R (late break)
	Spring-Up Terminal	HW-G10	HW-G01
		HW-G10R (early make)	HW-G01R (late break)
	Exposed Screw Terminal	HW-C10	HW-C01
		HW-C10R (early make)	HW-C01R (late break)
	Dummy Block	TW-DB	

- 1. There are no replacement parts for the HW1E unibody E-Stop.
- 2. For illuminated unibody E-Stop, see page 650 for replacement lens.

Contact Block Mounting Adaptor

Style	Part Number
	HW-CB2C

- 1. Used to mount contact blocks to operator.
- 2. IDEC strongly recommends using the safety lever lock to prevent heavy vibration or maintenance personnel from inadvertently unlocking contacts.

Safety Lever Lock

Style	Part Number
	HW9Z-LS

Anti-Rotation Ring

Appearance	Part Number
	HW9Z-RL

- Use with notched panel cutout to prevent unit rotation.

Operators

Style	Part Number	
ø40mm Head Push-Pull	Plastic	HW1B-Y2R
	Metal	HW4B-Y2R
	Plastic	HW1B-Y2Y
	Metal	HW4B-Y2Y

- All E-Stop Buttons are not removable from the operator.

**E-Stop Stations**



	29mm Pushlock Turn Reset		40mm Pushlock Turn Reset	
Contacts	Plastic Bezel	Metal Bezel	Plastic Bezel	Metal Bezel
1NO-1NC	FB1W-HW1B-V311R	FB1W-HW4B-V311R	FB1W-HW1B-V411R	FB1W-HW4B-V411R
2NC	FB1W-HW1B-V302R	FB1W-HW4B-V302R	FB1W-HW1B-V402R	FB1W-HW4B-V402R



	40mm Push-Pull Reset		40mm Pushlock Key Reset	
Contacts	Plastic Bezel	Metal Bezel	Plastic Bezel	Metal Bezel
1NO-1NC	FB1W-HW1B-Y211R	FB1W-HW4B-Y211R	FB1W-HW1B-X411R	FB1W-HW4B-X411R
2NC	FB1W-HW1B-Y202R	FB1W-HW4B-Y202R	FB1W-HW1B-X402R	FB1W-HW4B-X402R



	40mm EMO Pushlock Turn Reset	
Contacts	Plastic Bezel	Metal Bezel
1NO-1NC	FB1W-HW1B-V411R-EMO-2	FB1W-HW4B-V411R-EMO-2
2NC	FB1W-HW1B-V402R-EMO-2	FB1W-HW4B-V402R-EMO-2

- 1. Maximum of two contact blocks.
- 2. Box is supplied with yellow top and black bottom only.

### Jumbo Dome Pilot Lights (Assembled)



Plastic Bezel

Jumbo Dome	LED	Operator Only	HW1P-5Q0
		Full Voltage 24V AC/DC	HW1P-5Q4-Ⓢ
	Incandescent	Operator Only	HW1P-5Q7*
		Full Voltage 24V AC/DC	HW1P-5Q7-Ⓢ

Actual Size



1. In place of Ⓢ, specify the Lens/LED Color Code.
2. \*Incandescent operator comes with bulb.
3. Available with spring-up terminals in 24V only.
4. For nameplates and accessories, see page 646 and 649.
5. For dimensions, see page 651.

#### Ⓢ Lens/LED Color Code

Color	Code
Amber	A
Green	G
Red	R
Blue	S
White	PW
Yellow	Y



#### Jumbo Dome Replacement Parts

Item	Appearance	Description	Part Number
Lens		Polycarbonate Lens	HW1A-P5Ⓢ
LED Diffusing Lens*			HW9Z-PP5C
LED Lamps		LED Lamp	LSTDB-2Ⓢ



1. In place of Ⓢ, specify the Lens/LED Color Code.
2. \*Diffusing lens for LED models only.
3. Use white LED for yellow lens.

#### Lamp Ratings

	Part Number	Operating Voltage	Rated Current	Power Consumption
LED	LSTDB-2	24V AC/DC ±10%	15mA	0.36W
Incandescent	LSB-2		150mA	3.6W



\*Use PW for LED module, use C for lens.

Pilot Lights (Assembled)



		Round Flush		Dome	
		Plastic Bezel	Metal Bezel	Plastic Bezel	Metal Bezel
<i>Operator Only</i>		HW1P-1FQ0-②	HW4P-1FQ0-②	HW1P-2FQ0-②	HW4P-2FQ0-②
Full Voltage		HW1P-1FQ④-②-③	HW4P-1FQ④-②-③	HW1P-2FQ④-②-③	HW4P-2FQ④-②-③
Transformer	120V AC	HW1P-1FH2④-②	HW4P-1FH2④-②	HW1P-2FH2④-②	HW4P-2FH2④-②
	240V AC	HW1P-1FM4④-②	HW4P-1FM4④-②	HW1P-2FM4④-②	HW4P-2FM4④-②
	480V AC	HW1P-1FT8④-②	HW4P-1FT8④-②	HW1P-2FT8④-②	HW4P-2FT8④-②
DC-DC Converter*	110V DC	HW1P-1D2D-②	—	HW1P-2D2D-②	—



		Square Flush	
		Plastic Bezel	Metal Bezel
<i>Operator Only</i>		HW2P-1FQ0-②	
Full Voltage		HW2P-1FQ④-②-③	
Transformer	120V AC	HW2P-1FH2④-②	
	240V AC	HW2P-1FM4④-②	
	480V AC	HW2P-1FT8④-②	
DC-DC Converter*	110V DC	HW2P-1D2D-②	

② Lens/LED Color Code

Color	Code
Amber	A
Green	G
Red	R
Blue	S
White	W
Yellow	Y

③ Full Voltage Code

Voltage	Code
6VAC/DC	6V
12VAC/DC	12V
24VAC/DC	24V
120V AC (LED only)	120V
240V AC (LED only)	240V

④ Lamp Type Code

Lamp	Code
Incandescent	Blank
LED	D



1. In place of ②, specify the Lens/LED Color Code from table below.
2. In place of ③ specify the Full Voltage Code from table below.
3. In place of ④ specify Lamp Type Code from table below.
4. \*DC-DC convertor voltage input from 90-140V DC, comes with spring-up terminals only.
5. DC-DC converter models with LED lamps only.
6. For nameplates and accessories, see page 646 and 649.
7. For dimensions, see page 651.
8. **Pilot lights do not come with anti-rotation ring.**
9. Operator models come with operator and lens.
10. **Yellow pilot light comes with white LED.**



### Part Number Structure

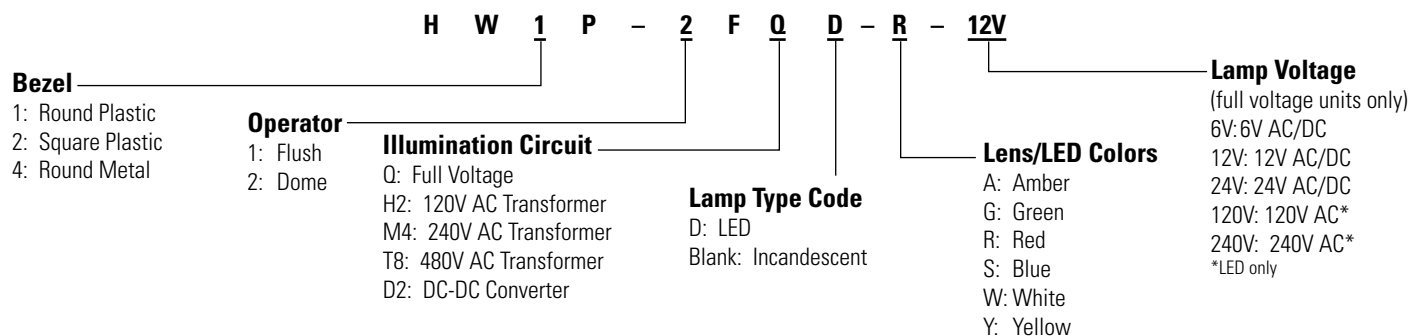

### Pilot Lights (Replacement Parts)

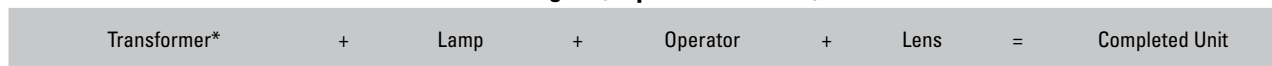

(not applicable for full voltage units)

### Transformer Units

Style	Voltage	Part Number
 (6V secondary voltage)	120V AC	HW-FH20 HW-MH20*
	240V AC	HW-FM40 HW-MM40*
	480V AC	HW-FT80 HW-RT80*
	110V DC**	HW-RD0*

- \*With spring-up terminals - to use spring-up terminal type, must use transformer type operator designed for spring-up transformer.
- \*\* DC-DC converter voltage input from 90-140V DC.

### Lamps

Style	Voltage	Part Number
	6V AC/DC	LSTD-6Ⓞ
	12V AC/DC	LSTD-1Ⓞ
	24V AC/DC	LSTD-2Ⓞ
	120V AC	LSTD-H2Ⓞ
	240V AC	LSTD-M4Ⓞ
	6V AC/DC	IS-6
	12V AC/DC	IS-12
	24V AC/DC	IS-24

- In place of Ⓞ, specify the LED Color Code.
- The LED contains a current-limiting resistor and reverse polarity protection diodes.

### ② LED Color Code

Color	Code	Color	Code
Amber	A	Blue	S
Green	G	White	W
Red	R		

 For yellow lens use white LED.

### Operators

Style	Type	Plastic Bezel	Metal Bezel
	Full Voltage	Standard	HW1P-1FQ0
		Spring-up Terminals	HW1P-1Q0
	Transformer	Standard	HW1P-10
		Spring-up Terminals	HW1P-100
	Full Voltage	Standard	HW1P-2FQ0
		Spring-up Terminals	HW1P-2Q0
	Transformer	Standard	HW1P-20
		Spring-up Terminals	HW1P-200
	Full Voltage	Standard	HW2P-1FQ0
		Spring-up Terminals	HW2P-1Q0
	Transformer	Standard	HW2P-10
		Spring-up Terminals	HW2P-100

- Transformer type requires separate transformer & lamp. Must select correct transformer bases on standard or spring up terminal type. Use 6V lamps or LEDs.
- Full voltage type only requires lamp.

### Lenses

Style	Part Number
	HW1A-P1-③
	HW1A-P2-③
	HW2A-P1-③

 In place of ③, specify the Lens Color Code.

### ③ Lens Color Code

Color	Code
Amber	A
Green	G
Red	R
Blue	S
White	W
Yellow	Y

 For yellow lens use white LED.

Illuminated Round Pushbuttons (Assembled)



Illuminated Full Voltage Pushbuttons



Contacts	Flush		Extended		Extended w/ Full Shroud	
	Plastic Bezel	Metal Bezel	Plastic Bezel	Metal Bezel	Plastic Bezel	Metal Bezel
<b>Momentary</b>						
<i>Operator Only</i>	<i>HW1L-M1-②</i>	<i>HW4L-M1-②</i>	<i>HW1L-M2-②</i>	<i>HW4L-M2-②</i>	<i>HW1L-MF2-②</i>	<i>HW4L-MF2-②</i>
1NO	HW1L-M1F10Q④-②-③	HW4L-M1F10Q④-②-③	HW1L-M2F10Q④-②-③	HW4L-M2F10Q④-②-③	HW1L-MF2F10Q④-②-③	HW4L-MF2F10Q④-②-③
1NC	HW1L-M1F01Q④-②-③	HW4L-M1F01Q④-②-③	HW1L-M2F01Q④-②-③	HW4L-M2F01Q④-②-③	HW1L-MF2F01Q④-②-③	HW4L-MF2F01Q④-②-③
1NO-1NC	HW1L-M1F11Q④-②-③	HW4L-M1F11Q④-②-③	HW1L-M2F11Q④-②-③	HW4L-M2F11Q④-②-③	HW1L-MF2F11Q④-②-③	HW4L-MF2F11Q④-②-③
2NO	HW1L-M1F20Q④-②-③	HW4L-M1F20Q④-②-③	HW1L-M2F20Q④-②-③	HW4L-M2F20Q④-②-③	HW1L-MF2F20Q④-②-③	HW4L-MF2F20Q④-②-③
<b>Maintained</b>						
<i>Operator Only</i>	<i>HW1L-A1-②</i>	<i>HW4L-A1-②</i>	<i>HW1L-A2-②</i>	<i>HW4L-A2-②</i>	<i>HW1L-AF2-②</i>	<i>HW4L-AF2-②</i>
1NO	HW1L-A1F10Q④-②-③	HW4L-A1F10Q④-②-③	HW1L-A2F10Q④-②-③	HW4L-A2F10Q④-②-③	HW1L-AF2F10Q④-②-③	HW4L-AF2F10Q④-②-③
1NC	HW1L-A1F01Q④-②-③	HW4L-A1F01Q④-②-③	HW1L-A2F01Q④-②-③	HW4L-A2F01Q④-②-③	HW1L-AF2F01Q④-②-③	HW4L-AF2F01Q④-②-③
1NO-1NC	HW1L-A1F11Q④-②-③	HW4L-A1F11Q④-②-③	HW1L-A2F11Q④-②-③	HW4L-A2F11Q④-②-③	HW1L-AF2F11Q④-②-③	HW4L-AF2F11Q④-②-③
2NO	HW1L-A1F20Q④-②-③	HW4L-A1F20Q④-②-③	HW1L-A2F20Q④-②-③	HW4L-A2F20Q④-②-③	HW1L-AF2F20Q④-②-③	HW4L-AF2F20Q④-②-③

Illuminated Transformer Pushbuttons



Contacts	Flush		Extended		Extended w/ Full Shroud	
	Plastic Bezel	Metal Bezel	Plastic Bezel	Metal Bezel	Plastic Bezel	Metal Bezel
<b>Momentary</b>						
<i>Operator Only</i>	<i>HW1L-M1-②</i>	<i>HW4L-M1-②</i>	<i>HW1L-M2-②</i>	<i>HW4L-M2-②</i>	<i>HW1L-MF2-②</i>	<i>HW4L-MF2-②</i>
1NO-1NC	HW1L-M1F11③④-②	HW4L-M1F11③④-②	HW1L-M2F11③④-②	HW4L-M2F11③④-②	HW1L-MF2F11③④-②	HW4L-MF2F11③④-②
2NO	HW1L-M1F20③④-②	HW4L-M1F20③④-②	HW1L-M2F20③④-②	HW4L-M2F20③④-②	HW1L-MF2F20③④-②	HW4L-MF2F20③④-②
<b>Maintained</b>						
<i>Operator Only</i>	<i>HW1L-A1-②</i>	<i>HW4L-A1-②</i>	<i>HW1L-A2-②</i>	<i>HW4L-A2-②</i>	<i>HW1L-AF2-②</i>	<i>HW4L-AF2-②</i>
1NO-1NC	HW1L-A1F11③④-②	HW4L-A1F11③④-②	HW1L-A2F11③④-②	HW4L-A2F11③④-②	HW1L-AF2F11③④-②	HW4L-AF2F11③④-②
2NO	HW1L-A1F20③④-②	HW4L-A1F20③④-②	HW1L-A2F20③④-②	HW4L-A2F20③④-②	HW1L-AF2F20③④-②	HW4L-AF2F20③④-②

- 1. In place of ②, specify Lens/LED Color Code from table.
- 2. In place of ③ specify Voltage Code from table.
- 3. In place of ④ specify Lamp Code from table.
- 4. Light independent of switch position.
- 5. For replacement part numbers, see page 617.
- 6. For nameplates and accessories, see page 646 and 649.
- 7. For dimensions, see page 651.
- 8. For contact assembly part numbers, see page 650.
- 9. Full voltage and transformer models use the same operator.
- 10. Additional contact configurations available (up to 6 total contacts).
- 11. Yellow pushbutton comes with white LED.**

② Lens/LED Color Code

Color	Code
Amber	A
Green	G
Red	R
Blue	S
White	W
Yellow	Y

Yellow LED not available. Use white LED for yellow lens.

③ Voltage Code

Full Voltage Models		Transformer Models	
Voltage	Code	Voltage	Code
6V AC/DC	6V	120V AC	H2
12V AC/DC	12V	240V AC	M4
24V AC/DC	24V	480V AC	T8
120V AC (LED only)	120V		
240V AC (LED only)	240V		

④ Lamp Code

Lamp	Code
Incandescent	Blank
LED	D



### Part Number Structure

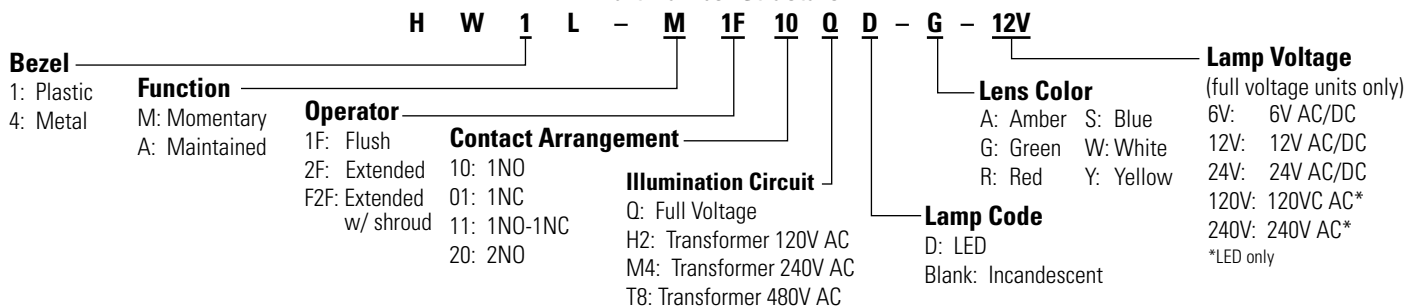

### Illuminated Round Pushbuttons (Replacement Parts)

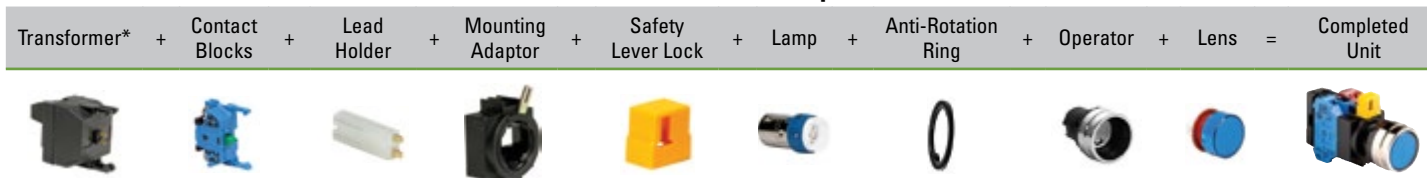

\*Transformer not needed with full voltage models.

### Lamp Circuit Components

Style	Description	Terminals	Part Number	
	For use with HW-CBL on all illuminated pushbutton units. One required for each deck (pair) of contacts.		HW-LH3	
	For use with odd number of contacts.	Fingersafe	HW-DA1FB	
		Exposed	HW-DA1B	
		Spring Up	HW-GA1	
	For use with even number of contacts.	Fingersafe	TW-DA1FB	
		Exposed	TW-DA1B	
	120VAC 240VAC 480VAC	Fingersafe	TW-F126B TW-F246B TW-F486B	
		Spring Up	120V 240V 480V	HW-T126 HW-T246 HW-L486
			Exposed	120V 240V 480V
	110VDC		HW-L16D	

HW-GA1 "Dummy Block with full voltage adaptor" does not require the use of HW-LH3.

### Operators

Style		Plastic Bezel	Metal Bezel
	Momentary	HW1L-M0	HW4L-M0
	Maintained	HW1L-A0	HW4L-A0
	Momentary	HW1L-MF0	HW4L-MF0
	Maintained	HW1L-AF0	HW4L-AF0

### Contact Blocks

Style	Contacts	1NO	1NC
	Standard Fingersafe (IP20)	HW-F10 HW-F10R (early make)	HW-F01 HW-F01R (late break)
	Spring-Up Terminal	HW-G10 HW-G10R (early make)	HW-G01 HW-G01R (late break)
	Exposed Screw Terminal	HW-C10 HW-C10R (early make)	HW-C01 HW-C01R (late break)

1. All assembled part numbers in catalog include standard fingersafe (HW-F..) contacts.  
 2. Assembled units with spring-up terminals (HW-G..) can be ordered by removing an "F" from the part number (Ex. HW1B-M1F11-R becomes HW1B-M111-R).  
 3. Units with exposed screw terminals (HW-C..) must be ordered as sub-components.

### Contact Block Mounting Adaptor

Style	Part Number
	HW-CBL

1. Used to mount contact blocks to operator (first pair only).  
 2. IDEC strongly recommends using the safety lever lock to prevent heavy vibration or maintenance personnel from inadvertently unlocking contacts.

### Safety Lever Lock

Style	Part Number
	HW9Z-LS

### Lenses

Style	Part Number
Round Flush	HW1A-L1-Ⓞ
Round Extended	HW1A-L2-Ⓞ

In place of Ⓞ, specify the Lens Color Code from previous page.

### Anti-Rotation Ring

Appearance	Part Number
	HW9Z-RL

Use with notched panel cutout to prevent unit rotation.

### Lamps

Style	Voltage	Part Number
	6V AC/DC	LSTD-6Ⓞ
	12V AC/DC	LSTD-1Ⓞ
	24V AC/DC	LSTD-2Ⓞ
	120V AC	LSTD-H2Ⓞ
	240V AC	LSTD-M4Ⓞ
	6V AC/DC	IS-6
	12V AC/DC	IS-12
	24V AC/DC	IS-24

1. In place of Ⓞ, specify the LED Color Code.  
 2. The LED contains a current-limiting resistor and reverse polarity protection diodes.  
 3. Yellow LED not available, use white LED when using yellow lens.

Illuminated Mushroom & Square Pushbuttons (Assembled)



		40mm Mushroom Head		Square Flush	
		Contacts	Plastic Bezel	Metal Bezel	
Full Voltage	Momentary	<i>Operator Only</i> <sup>†</sup>	<b>HW1L-M4-②</b>	<b>HW4L-M4-②</b>	<b>HW2L-M1-②</b>
		1NO	HW1L-M4F10Q④-②-③	HW4L-M4F10Q④-②-③	HW2L-M1F10Q④-②-③
		1NC	HW1L-M4F01Q④-②-③	HW4L-M4F01Q④-②-③	HW2L-M1F01Q④-②-③
		1NO-1NC	HW1L-M4F11Q④-②-③	HW4L-M4F11Q④-②-③	HW2L-M1F11Q④-②-③
		2NO	HW1L-M4F20Q④-②-③	HW4L-M4F20Q④-②-③	HW2L-M1F20Q④-②-③
	Maintained	<i>Operator Only</i> <sup>†</sup>	<b>HW1L-A4-②</b>	<b>HW4L-A4-②</b>	<b>HW2L-A1-②</b>
		1NO	HW1L-A4F10Q④-②-③	HW4L-A4F10Q④-②-③	HW2L-A1F10Q④-②-③
		1NC	HW1L-A4F01Q④-②-③	HW4L-A4F01Q④-②-③	HW2L-A1F01Q④-②-③
		1NO-1NC	HW1L-A4F11Q④-②-③	HW4L-A4F11Q④-②-③	HW2L-A1F11Q④-②-③
		2NO	HW1L-A4F20Q④-②-③	HW4L-A4F20Q④-②-③	HW2L-A1F20Q④-②-③
Transformer	Momentary	1NO-1NC	HW1L-M4F11③④-②	HW4L-M4F11③④-②	HW2L-M1F11③④-②
		2NO	HW1L-M4F20③④-②	HW4L-M4F20③④-②	HW2L-M1F20③④-②
	Maintained	1NO-1NC	HW1L-A4F11③④-②	HW4L-A4F11③④-②	HW2L-A1F11③④-②
		2NO	HW1L-A4F20③④-②	HW4L-A4F20③④-②	HW2L-A1F20③④-②



1. <sup>†</sup> Full voltage and transformer units use the same operator.
2. In place of ②, specify the Lens/LED Color Code from table.
3. In place of ③ specify the Voltage Code from table.
4. In place of ④ specify Lamp Type Code from table.
5. Light independent of switch position
6. For nameplates and accessories, see page 646 and 649.
7. For dimensions, see page 651.
8. For contact assembly part numbers, see page 650.
9. Additional contact configurations available (up to 6 total contacts).
10. **Yellow pushbutton comes with white LED.**

② Lens/LED Color Code

Color	Code
Amber	A
Green	G
Red	R
Blue	S
White	W
Yellow	Y*



1. \*40mm mushroom lenses not available in yellow.
2. Yellow LED not available. Use white LED for yellow lens.

③ Voltage Code

Full Voltage Models		Transformer Models	
Voltage	Code	Voltage	Code
6V AC/DC	6V	120V AC	H2
12V AC/DC	12V	240V AC	M4
24V AC/DC	24V	480V AC	T8
120V AC (LED only)	120V		
240V AC (LED only)	240V		

④ Lamp Code

Lamp	Code
Incandescent	Blank
LED	D

Part Number Structure

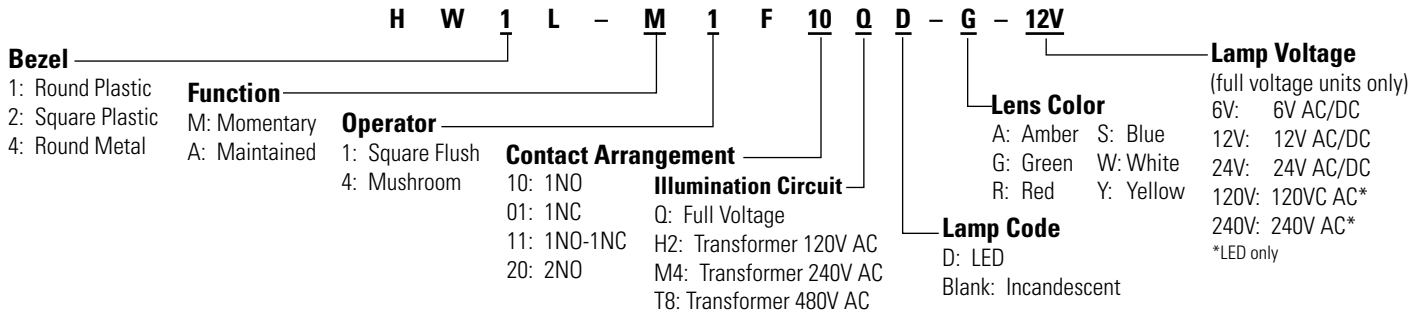

Illuminated Mushroom & Square Pushbuttons (Replacement Parts)

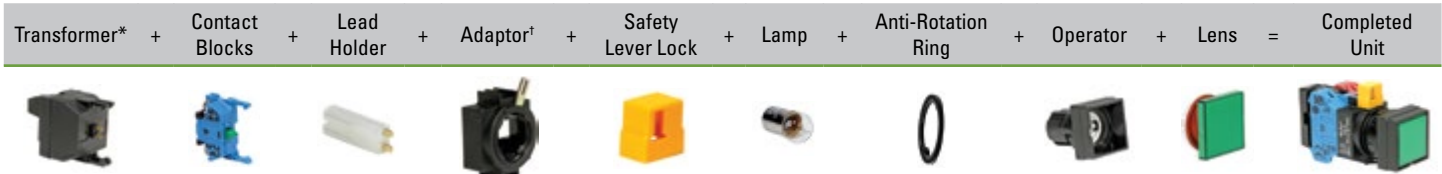

\*Transformer not needed with full voltage models.

Lamp Circuit Components

Style	Description	Terminals	Part Number
	For use with HW-CBL on all illuminated pushbutton units. One required for each deck (pair) of contacts.		HW-LH3
	For use with odd number of contacts.	Fingersafe	HW-DA1FB
		Exposed	HW-DA1B
		Spring Up	HW-GA1
	For use with even number of contacts.	Fingersafe	TW-DA1FB
		Exposed	TW-DA1B
	120VAC 240VAC 480VAC	Fingersafe	TW-F126B TW-F246B TW-F486B
		Spring Up	HW-T126 HW-T246 HW-L486
			Exposed
DC-DC Converter	110VDC		HW-L16D

HW-GA1 "Dummy Block with full voltage adaptor" does not require the use of HW-LH3.

Operators

Style	Plastic Bezel	Metal Bezel
ø40mm Mushroom	Momentary	HW1L-MOL HW4L-MOL
	Maintained	HW1L-AOL HW4L-AOL
Square	Momentary	HW2L-M0 -
	Maintained	HW2L-A0 -

Contact Blocks

Style	Contacts	1NO	1NC
	Standard Fingersafe (IP20)	HW-F10 HW-F10R (early make)	HW-F01 HW-F01R (late break)
	Spring-Up Terminal	HW-G10 HW-G10R (early make)	HW-G01 HW-G01R (late break)
	Exposed Screw Terminal	HW-C10 HW-C10R (early make)	HW-C01 HW-C01R (late break)

- 1. All assembled part numbers in catalog include standard fingersafe (HW-F...) contacts.
- 2. Assembled units with spring-up terminals (HW-G...) can be ordered by removing an "F" from the part number (Ex. HW1B-M1F11-R becomes HW1B-M111-R).
- 3. Units with exposed screw terminals (HW-C...) must be ordered as sub-components.

Contact Block Mounting Adaptor

Style	Part Number
	HW-CBL

- 1. Used to mount contact blocks to operator (first pair only).
- 2. IDEC strongly recommends using the safety lever lock to prevent heavy vibration or maintenance personnel from inadvertently unlocking contacts.

Safety Lever Lock

Style	Part Number
	HW9Z-LS

Lenses

Style	Part Number
ø40mm Mushroom Lens	ALW4BLU-⊙*
Square Flush	HW2A-L1-⊙

- 1. In place of ⊙, specify the Lens Color Code.
- 2. \*Mushroom lens not available in yellow.

Anti-Rotation Ring

Appearance	Part Number
	HW9Z-RL

- Use with notched panel cutout to prevent unit rotation.

Lamps

Style	Voltage	Part Number
	6V AC/DC	LSTD-6⊙
	12V AC/DC	LSTD-1⊙
	24V AC/DC	LSTD-2⊙
	120V AC	LSTD-H2⊙
	240V AC	LSTD-M4⊙
	6V AC/DC	IS-6
	12V AC/DC	IS-12
	24V AC/DC	IS-24

- 1. In place of ⊙, specify the LED Color Code.
- 2. The LED contains a current-limiting resistor and reverse polarity protection diodes.
- 3. Yellow LED not available, use white LED when using yellow lens.

**Selector Switches 2-Position (Assembled)**



**2-Position Selector Switches**

Contact	Mounting	Operator Position		Handle	Maintained	Spring Return from Right
		L	R			
<i>Operator Only</i>				<i>Knob Lever</i>	<i>HWⓈS-2T HWⓈS-2L</i>	<i>HWⓈS-21T HWⓈS-21L</i>
1NO	1	0	X	Knob Lever	HWⓈS-2TF10 HWⓈS-2LF10	HWⓈS-21TF10 HWⓈS-21LF10
1NO- 1NC	1 2	0 X	X 0	Knob Lever	HWⓈS-2TF11 HWⓈS-2LF11	HWⓈS-21TF11 HWⓈS-21LF11
2NO	1 2	0 0	X X	Knob Lever	HWⓈS-2TF20 HWⓈS-2LF20	HWⓈS-21TF20 HWⓈS-21LF20
2NO- 2NC	1 2 3 4	X 0 X 0	0 X 0 X	Knob Lever	HWⓈS-2TF22 HWⓈS-2LF22	HWⓈS-21TF22 HWⓈS-21LF22



1. In place of Ⓢ enter 1 for plastic bezel or 4 for metal bezel.
2. For nameplates, see page 646.
3. All assembled part numbers in catalog include standard fingersafe (HW-F...) contacts.
4. Assembled units with spring-up terminals (HW-G...) can be ordered by removing an "F" from the part number (Ex. HW1B-M1F11-R becomes HW1B-M111-R).
5. Units with exposed screw terminals (HW-C...) must be ordered as sub-components.
6. Standard color for knob and lever is black.
7. Optional colors available for lever type. Must order in components. See next page for part numbers.
8. Additional contact configurations available (up to 6 total contacts).
9. For Truth Tables see page 658.

**Ⓢ Bezel Type**

Type	Code
Plastic	1
Metal	4

Part Number Structure

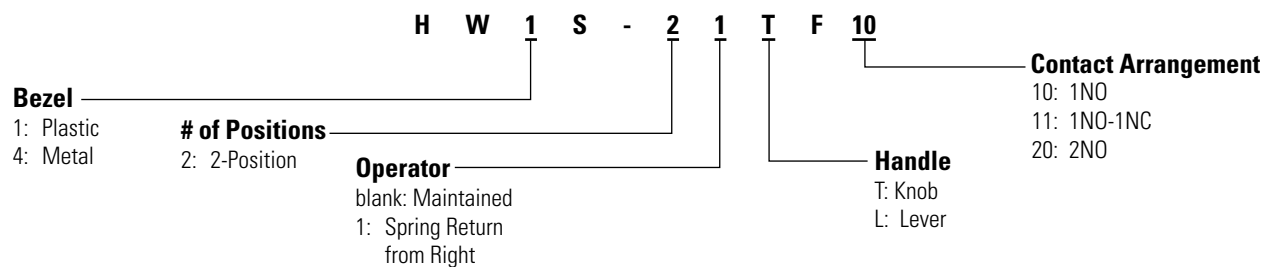

Selector Switches 2-Position (Replacement Parts)



Contact Blocks

Style	Contacts	1NO	1NC
Standard Fingersafe (IP20)		HW-F10	HW-F01
		HW-F10R (early make)	HW-F01R (late break)
Spring-Up Terminal		HW-G10	HW-G01
		HW-G10R (early make)	HW-G01R (late break)
Exposed Screw Terminal		HW-C10	HW-C01
		HW-C10R (early make)	HW-C01R (late break)
Dummy Block		TW-DB	

Anti-Rotation Ring

Style	Part Number
	HW9Z-RL

Use with notched panel cutout to prevent unit rotation.

Operators

Style	Description	Handle	Plastic Bezel	Metal Bezel
	Maintained	Knob	HW1S-2T	HW4S-2T
		Lever	HW1S-2	HW4S-2
	Spring Return from Right	Knob	HW1S-21T	HW4S-21T
		Lever	HW1S-21	HW4S-21

1. Knob operator comes with black handle.  
2. To order lever type, lever and inserts must be ordered separately, along with lever operator. See part numbers below.

Contact Block Mounting Adaptor

Style	Part Number
	HW-CB2C

1. Used to mount contact blocks to operator (first pair only).  
2. IDEC strongly recommends using the safety lever lock to prevent heavy vibration or maintenance personnel from inadvertently unlocking contacts.

Safety Lever Lock

Style	Part Number
	HW9Z-LS

Levers & Inserts

Style	Part Number
	Lever ASWHHL-⓪
	Lever Color Insert TW-HC1-⓪

Standard lever color is black. Standard insert color is white.

① Handle/Insert Color Code

Color	Code
Black*	B
Blue	S
Green	G
Red	R
Yellow	Y
White†	W

1. \* Lever color inserts not available in black.  
2. †Lever not available in white.

**Selector Switches 3-Position (Assembled)**



**3-Position Selector Switches**

Contact	Mounting	Operator Position			Handle	Maintained	Spring Return from Right	Spring Return from Left	Spring Return Two-Way
		L	C	R					
<i>Operator Only</i>					<i>Knob Lever</i>	<i>HW⊙S-3T* HW⊙S-3L</i>	<i>HW⊙S-31T HW⊙S-31L</i>	<i>HW⊙S-32T HW⊙S-32L</i>	<i>HW⊙S-33T HW⊙S-33L</i>
1NO-1NC	1	0	X	X	Knob Lever	HW⊙S-3TF11 HW⊙S-3LF11	HW⊙S-31TF11 HW⊙S-31LF11	HW⊙S-32TF11 HW⊙S-32LF11	HW⊙S-33TF11 HW⊙S-33LF11
	2	0	0	X					
2NO	1	X	0	0	Knob Lever	HW⊙S-3TF20 HW⊙S-3LF20	HW⊙S-31TF20 HW⊙S-31LF20	HW⊙S-32TF20 HW⊙S-32LF20	HW⊙S-33TF20 HW⊙S-33LF20
	2	0	0	X					
2NC	1	0	X	X	Knob Lever	HW⊙S-3TF02 HW⊙S-3LF02	HW⊙S-31TF02 HW⊙S-31LF02	HW⊙S-32TF02 HW⊙S-32LF02	HW⊙S-33TF02 HW⊙S-33LF02
	2	X	X	0					
2NO-1NC	1	X	0	0	Knob	HW⊙S-3JTF21N1	-	-	-
	2	0	0	X					
	3	0	X	0					
2NO-2NC	1	X	0	0	Knob	HW⊙S-3TF22	HW⊙S-31TF22	HW⊙S-32TF22	HW⊙S-33TF22
	2	0	0	X					
	3	0	X	X					
	4	X	X	0					
2NO-2NC	1	0	0	X	Knob	HW⊙S-3STF22N9	-	-	-
	2	X	0	0					
	3	X	X	0					
	4	0	0	X					
4NO	1	X	0	0	Knob	HW⊙S-3TF40	HW⊙S-31TF40	HW⊙S-32TF40	HW⊙S-33TF40
	2	0	0	X					
	3	X	0	0					
	4	0	0	X					
4NO	1	X	0	0	Knob	HW⊙S-3STF40N2	-	-	-
	2	0	X	X					
	3	X	0	0					
	4	0	0	X					
4NC	1	0	X	X	Knob	HW⊙S-3TF04	HW⊙S-31TF04	HW⊙S-32TF04	HW⊙S-33TF04
	2	X	X	0					
	3	0	X	X					
	4	X	X	0					

**Ⓢ Bezel Type**

Type	Code
Plastic	1
Metal	4

- In place of ⊙ enter 1 for plastic bezel or 4 for metal bezel.
- Knob operator includes black knob/lever operator includes black lever.
- \* Three position operator is available with three different cams.  
HW⊙S-3T: Maintained (standard cam)  
HW⊙S-3ST: Maintained (S cam)  
HW⊙S-3JT: Maintained (J cam)
- Operator cams are color coded (white=standard cam, red=S cam, black =J cam).
- For nameplates, see page 646.
- For contact assembly part numbers, see page 650.
- All assembled part numbers in catalog include standard fingersafe (HW-F...) contacts.
- Assembled units with spring-up terminals (HW-G...) can be ordered by removing an "F" from the part number (Ex. HW1B-M1F11-R becomes HW1B-M111-R).
- Units with exposed screw terminals (HW-C...) must be ordered as sub-components.
- Standard color for knob and lever is black.
- Optional colors available for lever type. Must order in components. See next page for part numbers.
- Additional contact configurations available (up to 6 total contacts).
- For Truth Tables see page 658.



Part Number Structure

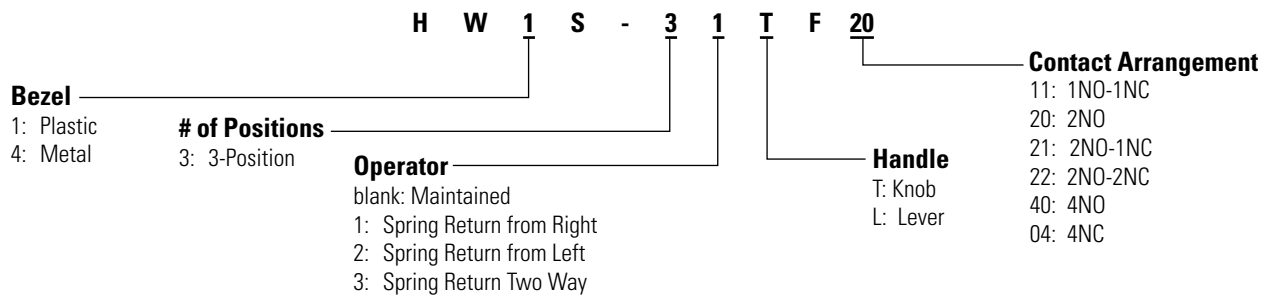

Selector Switches 3-Position (Replacement Parts)



Contact Blocks

Style	Contacts	1NO	1NC
Standard Fingersafe (IP20)		HW-F10	HW-F01
		HW-F10R (early make)	HW-F01R (late break)
Spring-Up Terminal		HW-G10	HW-G01
		HW-G10R (early make)	HW-G01R (late break)
Exposed Screw Terminal		HW-C10	HW-C01
		HW-C10R (early make)	HW-C01R (late break)
Dummy Block		TW-DB	

Anti-Rotation Ring

Style	Part Number
	HW9Z-RL

Use with notched panel cutout to prevent unit rotation.

Operators

Style	Description	Handle	Plastic Bezel	Metal Bezel
	Maintained (standard cam)	Knob	HW1S-3T	HW4S-3T
		Lever	HW1S-3	HW4S-3
	Maintained (S cam)	Knob	HW1S-3ST	HW4S-3ST
		Knob	HW1S-3JT	HW4S-3JT
	Spring Return from Right (standard cam)	Knob	HW1S-31T	HW4S-31T
		Lever	HW1S-31	HW4S-31
	Spring Return from Left (standard cam)	Knob	HW1S-32T	HW4S-32T
		Lever	HW1S-32	HW4S-32
	2-Way Spring Return (standard cam)	Knob	HW1S-33T	HW4S-33T
		Lever	HW1S-33	HW4S-33

- 1. Knob operator comes with black handle.
- 2. Three position knob operator is available with three different cams.
- 3. Operator cams are color coded (white=standard cam, red=S cam, black=J cam).
- 4. To order lever type, lever and inserts must be ordered separately, along with lever operator. See part numbers below.

Contact Block Mounting Adaptor

Style	Part Number
	HW-CB2C

- 1. Used to mount contact blocks to operator (first pair only).
- 2. IDEC strongly recommends using the safety lever lock to prevent heavy vibration or maintenance personnel from inadvertently unlocking contacts.

Safety Lever Lock

Style	Part Number
	HW9Z-LS

Levers & Inserts

Style	Part Number
	ASWHHL-①
	TW-HC1-①

Standard lever color is black. Standard insert color is white.

① Handle/Insert Color Code

Color	Code	Color	Code
Black*	B	Red	R
Blue	S	Yellow	Y
Green	G	White <sup>†</sup>	W

- 1. \* Lever color inserts not available in black.
- 2. <sup>†</sup>Lever not available in white.



Selector Switches 4- & 5-Position (Assembled)



4-Position Selector Switches

Contact	Mounting	Operator Position				Handle	Maintained
		1	2	3	4		
Operator Only						Knob Lever	HWⓈS-4T HWⓈS-4L
1NO- 2NC	1	X	0	0	0	Knob Lever	HWⓈS-4TF12 HWⓈS-4LF12
	2	0	X	0	0		
	3	0	0	X	0		
	4	0	0	0	0		
1NO- 3NC	1	0	X	X	X	Knob Lever	HWⓈS-4TF13N6 HWⓈS-4LF13N6
	2	0	X	0	0		
	3	0	0	X	0		
	4	0	0	0	X		
2NO- 2NC	1	X	0	0	0	Knob Lever	HWⓈS-4TF22N3 HWⓈS-4LF22N3
	2	0	X	0	0		
	3	0	0	X	0		
	4	0	0	0	X		

5-Position Selector Switch

Contact	Mounting	Operator Position					Handle	Maintained
		1	2	3	4	5		
Operator Only						Knob Lever	HWⓈS-5T HWⓈS-5L	
2NO- 2NC	1	X	0	0	0	0	Knob Lever	HWⓈS-5TF22N3 HWⓈS-5LF22N3
	2	0	X	0	0	0		
	3	0	0	0	X	0		
	4	0	0	0	0	X		



- In place of Ⓢ enter 1 for plastic bezel or 4 for metal bezel.
- Knob operator includes black knob/lever operator includes black lever.
- For nameplates, see page 646.
- For contact assembly part numbers, see page 650.
- Five position circuit cannot be made to make five independent contact closures.
- All assembled part numbers in catalog include standard fingersafe (HW-F...) contacts.
- Assembled units with spring-up terminals (HW-G...) can be ordered by removing an "F" from the part number (Ex. HW1B-M1F11-R becomes HW1B-M111-R).
- Units with exposed screw terminals (HW-C...) must be ordered as sub-components.
- Standard color for knob and lever is black.
- Optional colors available for lever type. Must order in components. See next page for part numbers.
- Additional contact configurations available (up to 6 total contacts).
- For Truth Tables see page 658.

Ⓢ Bezel Type

Type	Code
Plastic	1
Metal	4

Part Number Structure

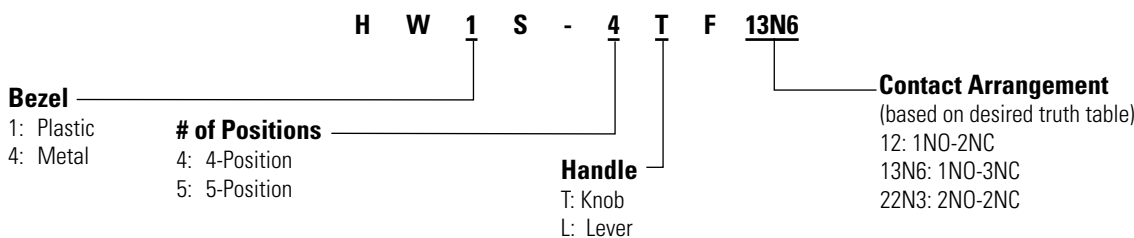

Selector Switches 4- & 5-Position (Replacement Parts)



Contact Blocks

Style	Contacts	1NO	1NC
Standard Fingersafe (IP20)		HW-F10	HW-F01
		HW-F10R (early make)	HW-F01R (late break)
Spring-Up Terminal		HW-G10	HW-G01
		HW-G10R (early make)	HW-G01R (late break)
Exposed Screw Terminal		HW-C10	HW-C01
		HW-C10R (early make)	HW-C01R (late break)
Dummy Block		TW-DB	

Anti-Rotation Ring

Style	Part Number
	HW9Z-RL

Use with notched panel cutout to prevent unit rotation.

Operators

Style	Position	Description	Handle	Plastic Bezel	Metal Bezel
	4	Maintained	Knob	HW1S-4T	HW4S-4T
			Lever	HW1S-4	HW4S-4
	5	Maintained	Knob	HW1S-5T	HW4S-5T
			Lever	HW1S-5	HW4S-5

- 1. Knob operator comes with black handle.
- 2. To order lever type, lever and inserts must be ordered separately, along with lever operator. See part numbers below.

Levers & Inserts

Style	Part Number
	ASWHHL-⓪
	TW-HC1-⓪

Standard lever color is black. Standard insert color is white.

① Handle/Insert Color Code

Color	Code
Black*	B
Blue	S
Green	G
Red	R
Yellow	Y
White†	W

- 1. \* Lever color inserts not available in black.
- 2. †Lever not available in white.

Contact Block Mounting Adaptor

Style	Part Number
	HW-CB2C

- 1. Used to mount contact blocks to operator (first pair only).
- 2. IDEC strongly recommends using the safety lever lock to prevent heavy vibration or maintenance personnel from inadvertently unlocking contacts.

Safety Lever Lock

Style	Part Number
	HW9Z-LS

Key Switches 2-Position (Assembled)

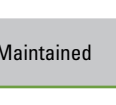
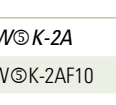

2-Position Key Switches

Contact	Mounting	Operator Position		Maintained	Spring Return from Right
		L	R	L 	L 
<i>Operator Only</i>					
1NO	1	0	X	HW⊙K-2AF10	HW⊙K-21BF10
1NO-1NC	1	0	X	HW⊙K-2AF11	HW⊙K-21BF11
	2	X	0		
2NO	1	0	X	HW⊙K-2AF20	HW⊙K-21BF20
	2	0	X		
2NO-2NC	1	0	X	HW⊙K-2AF22	HW⊙K-21BF22
	2	X	0		
	3	0	X		
	4	X	0		

- 1. In place of ⊙ enter 1 for plastic bezel or 4 for metal bezel.
- 2. Key is removable in all maintained positions. Other key removable options available.
- 3. Two keys are supplied with all switches.
- 4. All standard operators are keyed alike.
- 5. Other key removable options available. See table below
- 6. For nameplates, see page 646.
- 7. For contact assembly part numbers, see page 650.
- 8. Key is retained in "Spring Return" position.
- 9. All assembled part numbers in catalog include standard fingersafe (HW-F...) contacts.
- 10. Assembled units with spring-up terminals (HW-G...) can be ordered by removing an "F" from the part number (Ex. HW1B-M1F11-R becomes HW1B-M111-R).
- 11. Units with exposed screw terminals (HW-C...) must be ordered as sub-components.
- 12. Additional contact configurations available (up to 6 total contacts).
- 13. For Truth Tables see page 650.

⊙ Bezel Type

Type	Code
Plastic	1
Metal	4

Key Removable Option Codes

Code	Description
A	Key not retained in any position (removable in all positions)
B	Key retained in right position only
C	Key retained in left position only

**Part Number Structure**

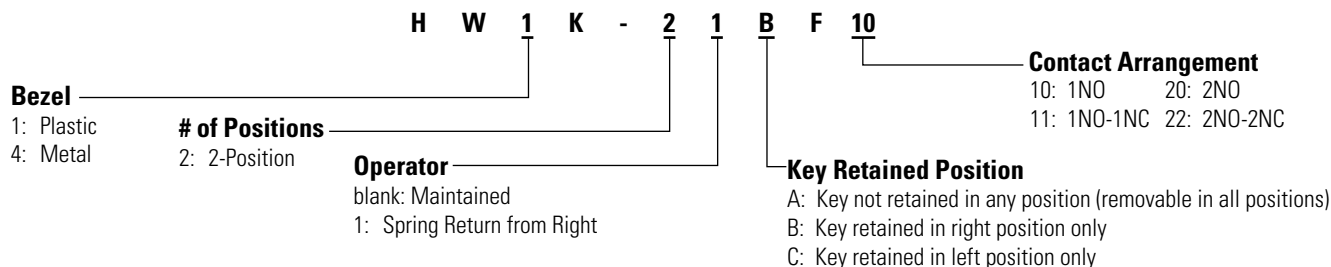

**Key Switches 2-Position (Replacement Parts)**

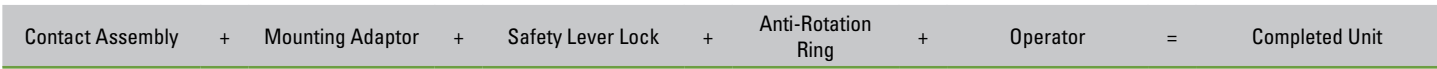

**Contact Blocks**

Style	Contacts	1NO	1NC
	Standard Fingersafe (IP20)	HW-F10	HW-F01
		HW-F10R (early make)	HW-F01R (late break)
	Spring-Up Terminal	HW-G10	HW-G01
		HW-G10R (early make)	HW-G01R (late break)
	Exposed Screw Terminal	HW-C10	HW-C01
		HW-C10R (early make)	HW-C01R (late break)
	Dummy Block	TW-DB	

**Safety Lever Lock**

Style	Part Number
	HW9Z-LS

**Anti-Rotation Ring**

Style	Part Number
	HW9Z-RL

Use with notched panel cutout to prevent unit rotation.

**Operators**

Style	Description	Plastic Bezel	Metal Bezel
	Maintained	HW1K-2A	HW4K-2A
	Maintained, key removed left only	HW1K-2B	HW4K-2B
	Spring Return from Right	HW1K-21B	HW4K-21B
	Maintained, key removed right only	HW1K-2C	HW4K-2C

1. Operator includes two keys.  
2. All standard operators are keyed alike.

**Contact Block Mounting Adaptor**

Style	Part Number
	HW-CB2C

1. Used to mount contact blocks to operator (first pair only).  
2. IDEC strongly recommends using the safety lever lock to prevent heavy vibration or maintenance personnel from inadvertently unlocking contacts.

Key Switches 3-Position (Assembled)



3-Position Key Switches

Contact	Mounting	Operator Position			Maintained	Spring Return from Right	Spring Return from Left	Spring Return Two Way
		L	C	R				
<b>Operator Only</b>								
					<i>HW⊙K-3A*</i>	<i>HW⊙K-31B</i>	<i>HW⊙K-32C</i>	<i>HW⊙K-33D</i>
1NO-1NC	1	0	X	X	HW⊙K-3AF11	HW⊙K-31BF11	HW⊙K-32CF11	HW⊙K-33DF11
	2	0	0	X				
2NO	1	X	0	0	HW⊙K-3AF20	HW⊙K-31BF20	HW⊙K-32CF20	HW⊙K-33DF20
	2	0	0	X				
2NC	1	0	X	X	HW⊙K-3AF02	HW⊙K-31BF02	HW⊙K-32CF02	HW⊙K-33DF02
	2	X	X	0				
2NO-1NC	1	X	0	0	HW⊙K-3JAF21N1	-	-	-
	2	0	0	X				
	3	0	X	0				
2NO-2NC	1	X	0	0	HW⊙K-3AF22	HW⊙K-31BF22	HW⊙K-32CF22	HW⊙K-33DF22
	2	0	0	X				
	3	0	X	X				
	4	X	X	0				
2NO-2NC	1	0	0	X	HW⊙K-3SAF22N9	-	-	-
	2	X	0	0				
	3	X	X	0				
	4	0	0	X				
4NO	1	X	0	0	HW⊙K-3AF40	HW⊙K-31BF40	HW⊙K-32CF40	HW⊙K-33DF40
	2	0	0	X				
	3	X	0	0				
	4	0	0	X				
4NO	1	X	0	0	HW⊙K-3SAF40N2	-	-	-
	2	0	X	X				
	3	X	0	0				
	4	0	0	X				
4NC	1	0	X	X	HW⊙K-3AF04	HW⊙K-31BF04	HW⊙K-32CF04	HW⊙K-33DF04
	2	X	X	0				
	3	0	X	X				
	4	X	X	0				

Ⓢ Bezel Type

Type	Code
Plastic	1
Metal	4

- In place of ⊙ enter 1 for plastic bezel or 4 for metal bezel.
- Key is removable in all maintained positions. Other key removable options available.
- Two keys are supplied with all switches.
- All standard operators are keyed alike.
- Other key removable options available. See table to the right.
- \* Operator is available with three different cams.  
HW⊙K-3A: Maintained (standard cam)  
HW⊙K-3SA: Maintained (Cam S)  
HW⊙K-3JA: Maintained (Cam J)
- For nameplates, see page 646.

- For contact assembly part numbers, see page 650.
- All assembled part numbers in catalog include standard fingersafe (HW-F...) contacts.
- Assembled units with spring-up terminals (HW-G...) can be ordered by removing an "F" from the part number (Ex. HW1B-M1F11-R becomes HW1B-M111-R).
- Units with exposed screw terminals (HW-C...) must be ordered as sub-components.
- Additional contact configurations available (up to 6 total contacts).
- For Truth Tables see page 658.

Key Removable Option Codes

Code	Description
A	Key not retained in any position (removable in all positions)
B	Key retained in right position only
C	Key retained in left position only
D	Key retained in left and right (3 position only)
E	Key retained in center only (3 position only)
G	Key retained right and center (3 position only)
H	Key retained left and center (3 position only)

Part Number Structure

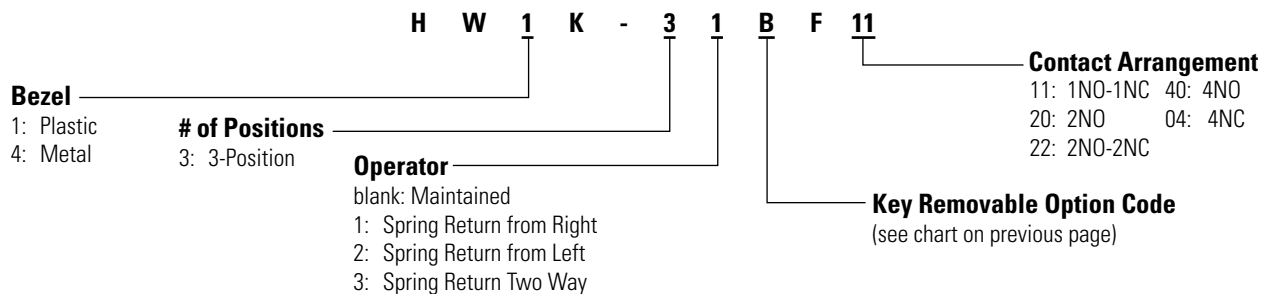

Key Switches 3-Position (Replacement Parts)

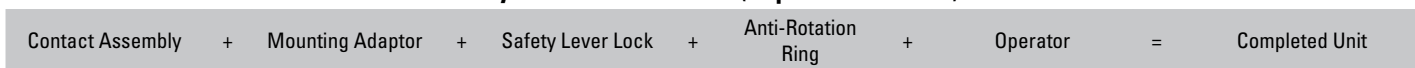

Contact Blocks

Style	Contacts	1NO	1NC
	Standard Fingersafe (IP20)	HW-F10	HW-F01
		HW-F10R (early make)	HW-F01R (late break)
	Spring-Up Terminal	HW-G10	HW-G01
		HW-G10R (early make)	HW-G01R (late break)
	Exposed Screw Terminal	HW-C10	HW-C01
		HW-C10R (early make)	HW-C01R (late break)
	Dummy Block	TW-DB	

Safety Lever Lock

Style	Part Number
	HW9Z-LS

Anti-Rotation Ring

Style	Part Number
	HW9Z-RL

Use with notched panel cutout to prevent unit rotation.

Operators

Style	Description	Plastic Bezel	Metal Bezel
	Maintained (standard cam)	HW1K-3A	HW4K-3A
	Maintained (S cam)	HW1K-3SA	HW4K-3SA
	Maintained (J cam)	HW1K-3JA	HW4K-3JA
	Spring Return from Right (standard cam)	HW1K-31B	HW4K-31B
	Spring Return from Left (standard cam)	HW1K-32C	HW4K-32C
	2-Way Spring Return (standard cam)	HW1K-33D	HW4K-33D

1. Operator includes two keys.  
2. All standard operators are keyed alike.  
3. Other key removable options available. See table on previous page.  
4. Key not removable from spring-returned position

Contact Block Mounting Adaptor

Style	Part Number
	HW-CB2C

1. Used to mount contact blocks to operator (first pair only).  
2. IDEC strongly recommends using the safety lever lock to prevent heavy vibration or maintenance personnel from inadvertently unlocking contacts.

Illuminated Selector Switches 2-Position (Assembled)



2-Position Illuminated Selector Switches

Contact	Mounting	Style		Part Number			
		Operator Position		Type	Maintained	Spring Return from Right	
		L	R		L	R	
<i>Operator Only</i>					HWⓂF-2②	HWⓂF-21②	
1NO-1NC	1 2	0 X	X 0	Full Voltage	HWⓂF-2F11Q④-②-③	HWⓂF-21F11Q④-②-③	
				Transformer	120V	HWⓂF-2F11H2④-②	HWⓂF-21F11H2④-②
					240V	HWⓂF-2F11M4④-②	HWⓂF-21F11M4④-②
2NO	1 2	X 0	0 X	Full Voltage	HWⓂF-2F20Q④-②-③	HWⓂF-21F20Q④-②-③	
				Transformer	120V	HWⓂF-2F20H2④-②	HWⓂF-21F20H2④-②
					240V	HWⓂF-2F20M4④-②	HWⓂF-21F20M4④-②
2NO-2NC	1 2 3 4	0 X 0 X	X 0 X 0	Full Voltage	HWⓂF-2F22Q④-②-③	HWⓂF-21F22Q④-②-③	
				Transformer	120V	HWⓂF-2F22H2④-②	HWⓂF-21F22H2④-②
					240V	HWⓂF-2F22M4④-②	HWⓂF-21F22M4④-②
				480V	HWⓂF-2F22T8④-②	HWⓂF-21F22T8④-②	



- In place of ② specify Lens/LED color code.
- In place of ③ specify Full Voltage code.
- In place of ④ specify Lamp code.
- In place of ⑤ enter 1 for plastic bezel or 4 for metal bezel.
- For nameplates, see page 646.
- For contact assembly part numbers, see page 650.
- Light is independent of switch position.
- All assembled part numbers in catalog include standard fingersafe (HW-F...) contacts.
- Assembled units with spring-up terminals (HW-G...) can be ordered by removing an "F" from the part number (Ex. HW1B-M1F11-R becomes HW1B-M111-R).
- Units with exposed screw terminals (HW-C...) must be ordered as sub-components.
- Yellow selector switch comes with white LED.**
- Additional contact configurations available (up to 6 total contacts).
- For Truth Tables see page 658.

② Lens/LED Color Code

Color	Code
Amber	A
Green	G
Red	R
Blue	S
White	W
Yellow	Y

③ Full Voltage Code

Full Voltage Models	
Voltage	Code
6VAC/DC	6V
12VAC/DC	12V
24VAC/DC	24V
120V AC (LED only)	120V
240V AC (LED only)	240V

④ Lamp Code

Lamp	Code
Incandescent	Blank
LED	D

⑤ Bezel Code

Type	Code
Plastic	1
Metal	4



### Part Number Structure

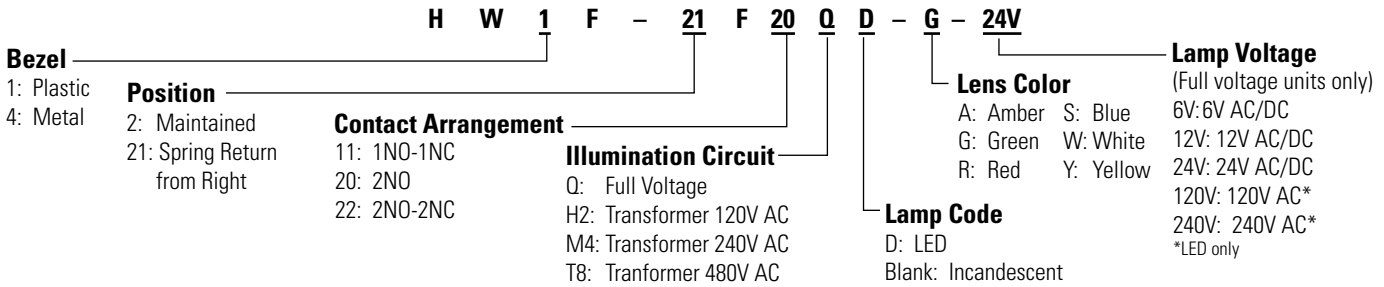

### Illuminated Selector Switches 2-Position (Replacement Parts)



\*Transformer not needed with full voltage models.

### Lamp Circuit Components

Style	Description	Terminals	Part Number
	For use with HW-CBL on all illuminated pushbutton units. One required for each deck (pair) of contacts.		HW-LH3
	For use with odd number of contacts.	Fingersafe	HW-DA1FB
		Exposed	HW-DA1B
		Spring Up	HW-GA1
	For use with even number of contacts.	Fingersafe	TW-DA1FB
		Exposed	TW-DA1B
	120VAC	Fingersafe	TW-F126B
	240VAC		TW-F246B
	480VAC		TW-F486B
	120V	Spring Up	HW-T126
	240V		HW-T246
	480V		HW-L486
120V	Exposed	TW-T126B	
		TW-T246B	
		TW-T486B	
DC-DC Converter	110VDC		HW-L16D

- 1. HW-GA1 "Dummy Block with full voltage adaptor" does not require the use of HW-LH3.
- 2. DC-DC converter features spring-up terminals.
- 3. DC-DC converter applicable voltage range 90-140V DC.

### Operators

Style	Description	Plastic Bezel	Metal Bezel
	Maintained	HW1F-2	HW4F-2
	Spring return from right	HW1F-21	HW4F-21

Illuminated knobs must be ordered separately.

### Contact Blocks

Style	Contacts	1NO	1NC
	Standard Fingersafe (IP20)	HW-F10 HW-F10R (early make)	HW-F01 HW-F01R (late break)
	Spring-Up Terminal	HW-G10 HW-G10R (early make)	HW-G01 HW-G01R (late break)
	Exposed Screw Terminal	HW-C10 HW-C10R (early make)	HW-C01 HW-C01R (late break)

### Contact Block Mounting Adaptor

Style	Part Number
	HW-CBL

- 1. Used to mount contact blocks to operator (first pair only).
- 2. IDEC strongly recommends using the safety lever lock to prevent heavy vibration or maintenance personnel from inadvertently unlocking contacts.

### Safety Lever Lock

Style	Part Number
	HW9Z-LS

### Illuminated Knob

Appearance	Part Number
	HW9Z-FDY-⊙

In place of ⊙, specify the Color Code.

### ⊙ Lens/LED Color Code

Color	Code	Color	Code
Amber	A	Blue	S
Green	G	White	W
Red	R	Yellow	Y

### Anti-Rotation Ring

Style	Part Number
	HW9Z-RL

Use with notched panel cutout to prevent unit rotation.

### Lamps

Style	Voltage	Part Number
	6V AC/DC	LSTD-6⊙
	12V AC/DC	LSTD-1⊙
	24V AC/DC	LSTD-2⊙
	120V AC	LSTD-H2⊙
	240V AC	LSTD-M4⊙
	6V AC/DC	IS-6
	12V AC/DC	IS-12
	24V AC/DC	IS-24

- 1. In place of ⊙, specify the LED Color Code.
- 2. The LED contains a current-limiting resistor and reverse polarity protection diodes.
- 3. Use white LED for yellow lens. Yellow LED not available.

Illuminated Selector Switches 3-Position (Assembled)



3-Position Illuminated Selector Switches

		Style			Part Number				
Contact	Mounting	Operator Position			Type	Maintained	Spring Return from Right	Spring Return from Left	Spring Return Two-Way
		L	C	R					
<b>Operator Only</b>									
1NO-1NC	1	0	X	X	Full Voltage	HWⓄF-3②			
	2	0	0	0		HWⓄF-31②			
						HWⓄF-32②			
2NO	1	X	0	0	Full Voltage	HWⓄF-3F11Q④-②-③			
	2	0	0	0		HWⓄF-31F11Q④-②-③			
						HWⓄF-32F11Q④-②-③			
2NC	1	0	X	X	Full Voltage	HWⓄF-3F20Q④-②-③			
	2	0	0	0		HWⓄF-31F20Q④-②-③			
						HWⓄF-32F20Q④-②-③			
2NO-2NC	1	X	0	0	Full Voltage	HWⓄF-3F02H2④-②			
	2	0	0	0		HWⓄF-31F02H2④-②			
	3	0	X	X		HWⓄF-32F02H2④-②			
4NO	1	X	0	0	Full Voltage	HWⓄF-3F02M4④-②			
	2	0	0	0		HWⓄF-31F02M4④-②			
	3	X	0	0		HWⓄF-32F02M4④-②			
4NC	1	0	X	X	Full Voltage	HWⓄF-3F02T8④-②			
	2	X	X	0		HWⓄF-31F02T8④-②			
	3	0	X	X		HWⓄF-32F02T8④-②			
2NO-2NC	1	X	0	0	Full Voltage	HWⓄF-3F40Q④-②-③			
	2	0	0	0		HWⓄF-31F40Q④-②-③			
	3	0	X	X		HWⓄF-32F40Q④-②-③			
4NO	1	X	0	0	Full Voltage	HWⓄF-3F40H2④-②			
	2	0	0	0		HWⓄF-31F40H2④-②			
	3	X	0	0		HWⓄF-32F40H2④-②			
4NC	1	0	X	X	Full Voltage	HWⓄF-3F40M4④-②			
	2	X	X	0		HWⓄF-31F40M4④-②			
	3	0	X	X		HWⓄF-32F40M4④-②			
4NO	1	0	X	X	Full Voltage	HWⓄF-3F40T8④-②			
	2	X	X	0		HWⓄF-31F40T8④-②			
	3	0	X	X		HWⓄF-32F40T8④-②			



- In place of ② specify Lens/LED color code.
- In place of ③ specify Full Voltage code.
- In place of ④ specify Lamp code.
- In place of ⑤ enter 1 for plastic bezel or 4 for metal bezel.
- For nameplates, see page 646.
- For contact assembly part numbers, see page 650.
- Light is independent of switch position.
- All assembled part numbers in catalog include standard fingersafe (HW-F...) contacts.
- Assembled units with spring-up terminals (HW-G...) can be ordered by removing an "F" from the part number (Ex. HW1B-M1F11-R becomes HW1B-M111-R).
- Units with exposed screw terminals (HW-C...) must be ordered as sub-components.
- 11. Yellow selector switch comes with white LED.**
- Additional contact configurations available (up to 6 total contacts).
- For Truth Tables see page 658.

② Lens/LED Color

Color	Code
Amber	A
Green	G
Red	R
Blue	S
White	W
Yellow	Y

③ Full Voltage Code

Full Voltage Models	
Voltage	Code
6VAC/DC	6V
12VAC/DC	12V
24VAC/DC	24V
120V AC (LED only)	120V
240V AC (LED only)	240V

④ Lamp Code

Lamp	Code
Incandescent	Blank
LED	D

⑤ Bezel Code

Type	Code
Plastic	1
Metal	4

### Part Number Structure

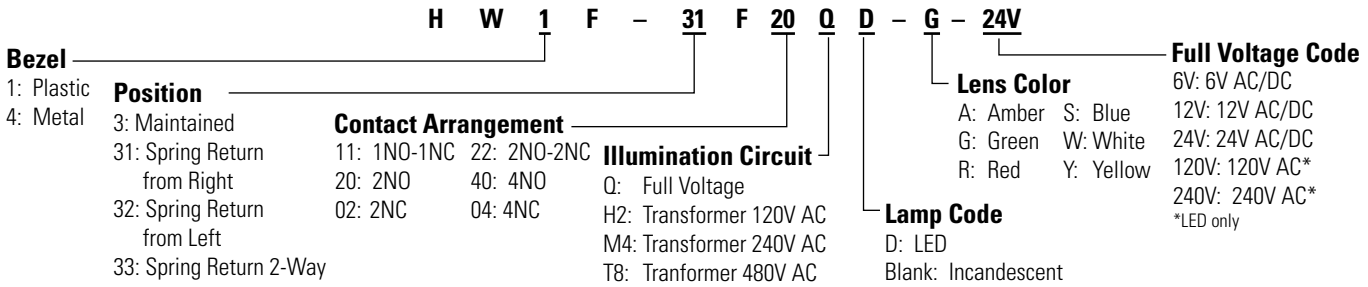

### Illuminated Selector Switches 3-Position (Replacement Parts)



\*Transformer not needed with full voltage models.

### Lamp Circuit Components

Style	Description	Terminals	Part Number
Lead Holder	For use with HW-CBL on all illuminated pushbutton units. One required for each deck (pair) of contacts.		HW-LH3
Dummy Block with Full Voltage Adaptor	For use with odd number of contacts.	Fingersafe	HW-DA1FB
		Exposed	HW-DA1B
		Spring Up	HW-GA1
Full Voltage Adaptor	For use with even number of contacts.	Fingersafe	TW-DA1FB
		Exposed	TW-DA1B
Transformer Unit (6V secondary voltage)	120VAC	Fingersafe	TW-F126B
	240VAC		TW-F246B
	480VAC		TW-F486B
	120V 240V 480V	Spring Up	HW-T126 HW-T246 HW-L486
DC-DC Converter	110VDC	Exposed	TW-T126B
			TW-T246B
			TW-T486B
			HW-L16D

- HW-GA1 "Dummy Block with full voltage adaptor" does not require the use of HW-LH3.
- DC-DC converter features spring-up terminals.
- DC-DC converter applicable voltage range 90-140V DC.

### Operators

Style	Description	Plastic Bezel	Metal Bezel
	Maintained	HW1F-3	HW4F-3
	Spring return from right	HW1F-31	HW4F-31
	Spring return from left	HW1F-32	HW4F-32
	2-Way spring return	HW1F-33	HW4F-33

Illuminated knobs must be ordered separately.

### Contact Blocks

Style	Contacts	1NO	1NC
	Standard Fingersafe (IP20)	HW-F10 HW-F10R (early make)	HW-F01 HW-F01R (late break)
	Spring-Up Terminal	HW-G10 HW-G10R (early make)	HW-G01 HW-G01R (late break)
	Exposed Screw Terminal	HW-C10 HW-C10R (early make)	HW-C01 HW-C01R (late break)

### Contact Block Mounting Adaptor

Style	Part Number
	HW-CBL

- Used to mount contact blocks to operator (first pair only).
- IEC strongly recommends using the safety lever lock to prevent heavy vibration or maintenance personnel from inadvertently unlocking contacts.

### Safety Lever Lock

Style	Part Number
	HW9Z-LS

### Illuminated Knob

Appearance	Part Number
	HW9Z-FDY-⊙

In place of ⊙, specify the Color Code.

### ⊙ Lens/LED Color Code

Color	Code	Color	Code
Amber	A	Blue	S
Green	G	White	W
Red	R	Yellow	Y

### Anti-Rotation Ring

Style	Part Number
	HW9Z-RL

Use with notched panel cutout to prevent unit rotation.

### Lamps

Style	Voltage	Part Number
	6V AC/DC	LSTD-6⊙
	12V AC/DC	LSTD-1⊙
	24V AC/DC	LSTD-2⊙
	120V AC 240V AC	LSTD-H2⊙ LSTD-M4⊙
	6V AC/DC	IS-6
	12V AC/DC	IS-12
	24V AC/DC	IS-24

- In place of ⊙, specify the LED Color Code.
- The LED contains a current-limiting resistor and reverse polarity protection diodes.
- Use white LED for yellow lens. Yellow LED not available.

**Mono Lever Switches 2-Position (Assembled)**



**2-Position Mono Lever Switches**

Style	Part Number	Description
HW1M Standard Lever	HW1M-F1010-20	Maintained up and down
	HW1M-F2020-20	Spring return up and down
	HW1M-F1010-40	Maintained up and down
	HW1M-F2020-40	Spring return up and down
	HW1M-F0101-20	Maintained right and left
	HW1M-F0202-20	Spring return right and left
	HW1M-F0101-40	Maintained right and left
HW1M-L Interlocking Lever	HW1M-F0202-40	Spring return right and left
	HW1M-LF1010-20	Maintained up and down
	HW1M-LF2020-20	Spring return up and down
	HW1M-LF1010-40	Maintained up and down
	HW1M-LF2020-40	Spring return up and down
	HW1M-LF0101-20	Maintained right and left
	HW1M-LF0202-20	Spring return right and left
HW1M-LF0101-40	HW1M-LF0101-40	Maintained right and left
	HW1M-LF0202-40	Spring return right and left

- 1. All assembled part numbers in catalog include standard (HW-F...) contacts.
- 2. Assembled units with spring-up terminals (HW-G...) can be ordered by removing an "F" from the part number (Ex. HW1B-M1F11-R becomes HW1B-M111-R).
- 3. Units with exposed screw terminals (HW-C...) must be ordered as sub-components.
- 4. Additional contact configurations available (up to 6 total contacts).

**Circuit Diagrams  
2 Position Left/Right**

Circuit Number	Contact Mounting		Position		
	No.		Left	Center	Right
20	1	HW-F10	X	0	0
	2	HW-F10	0	0	X
40	1	HW-F10	X	0	0
	2	HW-F10	0	0	X
	3	HW-F10	X	0	0
	4	HW-F10	0	0	X

**2 Position Up/Down**

Circuit Number	Contact Mounting		Position		
	No.		Down	Center	Up
20	1	HW-F10	X	0	0
	2	HW-F10	0	0	X
40	1	HW-F10	X	0	0
	2	HW-F10	0	0	X
	3	HW-F10	X	0	0
	4	HW-F10	0	0	X

Part Number Structure

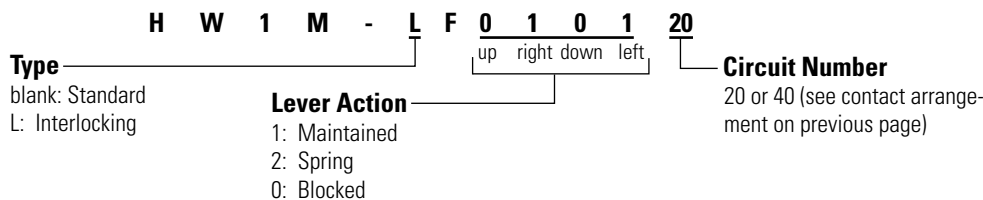

Mono Lever Switches 2-Position (Sub-assembled) Part Numbers

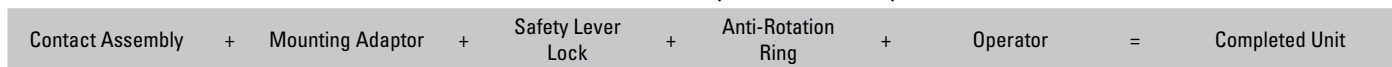

Contact Blocks

Style	Contacts	1NO	1NC
	Standard Fingersafe (IP20)	HW-F10	HW-F01
		HW-F10R (early make)	HW-F01R (late break)
	Spring-Up Terminal	HW-G10	HW-G01
		HW-G10R (early make)	HW-G01R (late break)
	Exposed Screw Terminal	HW-C10	HW-C01
		HW-C10R (early make)	HW-C01R (late break)
	Dummy Block	TW-DB	

Contact Block Mounting Adaptor

Style	Part Number
	HW-CB2C

- 1. Used to mount contact blocks to operator (first pair only).
- 2. IDEC strongly recommends using the safety lever lock (included) to prevent heavy vibration or maintenance personnel from inadvertently unlocking contacts.

Safety Lever Lock

Style	Part Number
	HW9Z-LS

Anti-Rotation Ring

Style	Part Number
	HW9Z-RL

Use with notched panel cutout to prevent unit rotation.

Operators

Style	Description	Part Number
	Maintained Up/Down	HW1M-1010
	Spring return Up/Down	HW1M-2020
	Maintained Left/Right	HW1M-0101
	Spring return Left/Right	HW1M-0202
	Maintained Up/Down	HW1M-L1010
	Spring return Up/Down	HW1M-L2020
	Maintained Left/Right	HW1M-L0101
	Spring return Left/Right	HW1M-L0202

Replacement Parts

Item	Part Number
Black Cap 	HW9Z-CPM
Boot 	HW9Z-BLM (fits standard operator only)

**Mono Lever Switches 3- & 4-Position (Assembled)**



**3-Position**

Style	Part Number	Description
HW1M Standard Lever	HW1M-F0121-12N3	Maintained right and left, spring return down
	HW1M-F0222-12N3	Spring return right, down, left
HW1M-L Interlocking Lever	HW1M-LF0121-12N3	Maintained right and left, spring return down
	HW1M-LF0222-12N3	Spring return right, down, left

**Circuit Diagram**

Circuit Number	Contact Mounting		Position				
	No.		Down	Left	Center	Up	Right
12N3	1	HW-F01	0	0	0	0	X
	2	HW-F01	X	0	0	0	0
	3	HW-F10	0	X	0	0	0

**4-Position**

Style	Part Number	Description
HW1M Standard Lever	HW1M-F1111-22N9	Maintained all positions
	HW1M-F1212-22N9	Maintained up and down, spring left and right
	HW1M-2121-22N9	Spring up and down, maintained left and right
	HW1M-2222-22N9	Spring return all positions
HW1M-L Interlocking Lever	HW1M-LF1111-22N9	Maintained all positions
	HW1M-LF1212-22N9	Maintained up and down, spring left and right
	HW1M-LF2121-22N9	Spring up and down, maintained left and right
	HW1M-LF2222-22N9	Spring return all positions

**Circuit Diagram**

Circuit Number	Contact Mounting		Position				
	No.		Down	Left	Center	Up	Right
22N9	1	HW-F01	0	0	0	0	X
	2	HW-F01	X	0	0	0	0
	3	HW-F10	0	X	0	0	0
	4	HW-F10	0	0	0	X	0

- 1. All assembled part numbers in catalog include standard (HW-F...) contacts.
- 2. Assembled units with spring-up terminals (HW-G...) can be ordered by removing an "F" from the part number (Ex. HW1B-M1F11-R becomes HW1B-M111-R).
- 3. Units with exposed screw terminals (HW-C...) must be ordered as sub-components.
- 4. Additional contact configurations available (up to 6 total contacts).



Part Number Structure

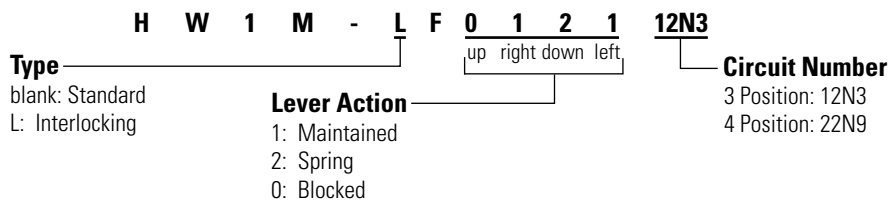

Mono Lever Switches 3 & 4-Position (Sub-assembled) Part Numbers

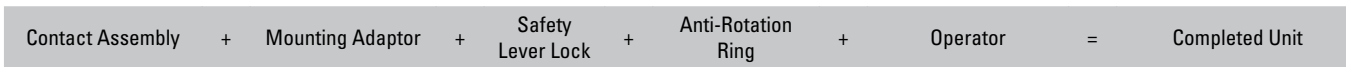

Contact Blocks

Style	Contacts	1NO	1NC
	Standard Fingersafe (IP20)	HW-F10	HW-F01
		HW-F10R (early make)	HW-F01R (late break)
	Spring-Up Terminal	HW-G10	HW-G01
		HW-G10R (early make)	HW-G01R (late break)
	Exposed Screw Terminal	HW-C10	HW-C01
		HW-C10R (early make)	HW-C01R (late break)
	Dummy Block	TW-DB	

Anti-Rotation Ring

Style	Part Number
	HW9Z-RL



Use with notched panel cutout to prevent unit rotation.

Operators

Style	Description	Part Number
	Standard	
	Combination, 3 position	HW1M-0121
	Spring return, 3 position	HW1M-0222
	Maintained, 4 position	HW1M-1111
	Combination, 4 position	HW1M-1212
	Combination, 4 position	HW1M-2121
	Interlocking	
	Combination, 3 position	HW1M-L0121
	Spring return, 3 position	HW1M-L0222
	Maintained, 4 position	HW1M-L1111
	Combination, 4 position	HW1M-L1212
	Combination, 4 position	HW1M-L2121
	Spring return, 4 position	HW1M-L2222

Replacement Parts

Item	Part Number
Black Cap	HW9Z-CPM
Boot	HW9Z-BLM (fits standard operator only)

Contact Block Mounting Adaptor

Style	Part Number
	HW-CB2C

- 1. Used to mount contact blocks to operator (first pair only).
- 2. IDEC strongly recommends using the safety lever lock (included) to prevent heavy vibration or maintenance personnel from inadvertently unlocking contacts.

Safety Lever Lock

Style	Part Number
	HW9Z-LS



Pushbutton Selectors (Assembled)



2-Position Pushbutton Selectors

Cam	Contacts	Mounting	Operator Position				Part Number	
			Left		Right			
			Normal	Push	Normal	Push		
<b>A</b>	<i>Operator Only</i>						HW1R-2A-①	
	1NO-1NC	1	HW-F10	0	X	0	X	HW1R-2AF11-①
		2	HW-F01	X	0	0	0	
	2NO	1	HW-F10	0	X	0	X	HW1R-2AF20-①
		2	HW-F10	0	X	X	X	
2NO-2NC	1	HW-F10	0	X	0	X	HW1R-2AF22-①	
	2	HW-F01	X	0	0	0		
	3	HW-F10	0	X	0	X		
	4	HW-F01	X	0	0	0		
<b>D</b>	<i>Operator Only</i>						HW1R-2D-①	
	2NO	1	HW-F10	0	X	0	0	HW1R-2DF20-①
		2	HW-F10	0	0	0	X	
	2NO-2NC	1	HW-F10	0	X	0	0	HW1R-2DF22N1-①
		2	HW-F10	0	0	0	X	
3		HW-F01	X	0	X	X		
	4	HW-F01	X	X	X	0		
<b>E</b>	<i>Operator Only</i>						HW1R-2E-①	
	2NO-2NC	1	HW-F10	0	X	0	0	HW1R-2EF22N1-①
		2	HW-F10	0	0	0	X	
		3	HW-F01	0	0	X	X	
		4	HW-F01	X	X	0	0	
<b>F</b>	<i>Operator Only</i>						HW1R-2F-①	
	2NO-2NC	1	HW-F10	0	0	0	X	HW1R-2FF22N1-①
		2	HW-F10	0	X	0	0	
		3	HW-F01	0	0	X	0	
		4	HW-F01	X	0	0	0	
<b>N</b>	<i>Operator Only</i>						HW1R-2N-①	
	2NO-2NC	1	HW-F01	0	0	X	0	HW1R-2NF22N2-①
		2	HW-F10	0	X	0	X	
		3	HW-F01	0	0	X	0	
		4	HW-F10	0	X	0	X	
<b>T</b>	<i>Operator Only</i>						HW1R-2T-①	
	2NO-2NC	1	HW-F10	0	X	X		HW1R-2TF22N1-①
		2	HW-F10	0	X	X		
		3	HW-F01	X	0	0	Blocked	
		4	HW-F01	X	0	0		

① Button Color Code

Color	Code	Color	Code
Black	B	White	W
Green	G	Yellow	Y
Red	R	Gray	N
Blue	S		



- All assembled part numbers in catalog include standard (HW-F...) contacts.
- Assembled units with spring-up terminals (HW-G...) can be ordered by removing an "F" from the part number (Ex. HW1B-M1F11-R becomes HW1B-M111-R).
- Units with exposed screw terminals (HW-C...) must be ordered as sub-components.
- Operator only models come with operator and button.
- Additional contact configurations available (up to 6 total contacts).

Part Number Structure

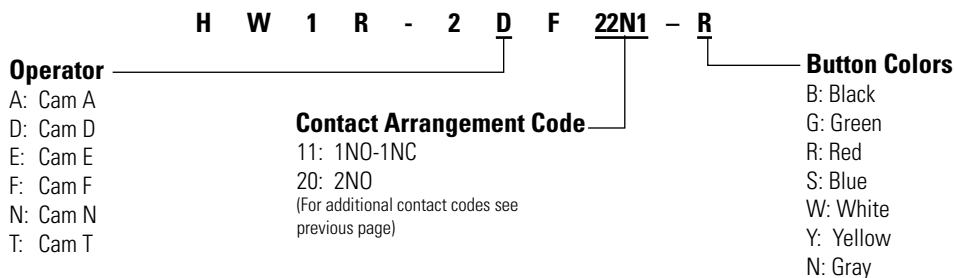

Pushbutton Selectors (Sub-assembled)

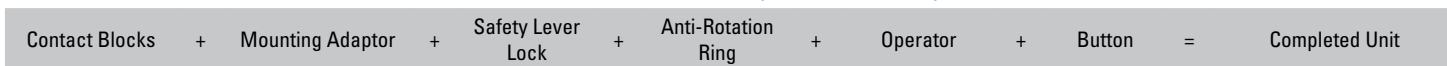

Contact Blocks

Style	Contacts	1NO	1NC
	Standard Fingersafe (IP20)	HW-F10	HW-F01
		HW-F10R (early make)	HW-F01R (late break)
	Spring-Up Terminal	HW-G10	HW-G01
		HW-G10R (early make)	HW-G01R (late break)
	Exposed Screw Terminal	HW-C10	HW-C01
		HW-C10R (early make)	HW-C01R (late break)
	Dummy Block	TW-DB	

Contact Block Mounting Adaptor

(safety lever lock included)

Style	Part Number
	HW-CB2C

- 1. Used to mount contact blocks to operator (first pair only).
- 2. IDEC strongly recommends using the safety lever lock (included) to prevent heavy vibration or maintenance personnel from inadvertently unlocking contacts.

Safety Lever Lock

Style	Part Number
	HW9Z-LS

Anti-Rotation Ring

Style	Part Number
	HW9Z-RL

Use with notched panel cutout to prevent unit rotation.

Operators

Style	Description	Part Number
	Cam A	HW1R-2A
	Cam D	HW1R-2D
	Cam E	HW1R-2E
	Cam F	HW1R-2F
	Cam N	HW1R-2N
	Cam T	HW1R-2T

Buttons

Style	Part Number
Round Flush	HW1A-B1-Ⓢ

In place of Ⓢ, specify the Button Color Code from table below.

Ⓢ Button Color Code

Color	Code	Color	Code
Black	B	White	W
Green	G	Yellow	Y
Red	R	Gray	N
Blue	S		

### Dual Pushbutton Switches

**Key features:**

- Two pushbuttons and a pilot light are integrated into one space-saving ø22 mm control unit.
- Momentary and interlock types are available for pushbuttons. Interlock type prevents both buttons from being pressed at the same time.
- Pilot lights are available in full voltage and transformer with LED or incandescent lamps.
- IP40 protection, IP65 when using silicon cover.
- UL Listed, CSA approved, and EN compliant



**Applications:**

- Ideal for use as power switches and start/stop switches (available with I/ON and O/OFF markings on the buttons and a pilot light in the center).
- Interlock type prevents two pushbuttons from being pressed at the same time.



### Dual Pushbutton Switches (Assembled) Part Numbers

**Without Center Pilot Light**

Operation Type	Button Style	Image	Contact Arrangement		Part Number	Ⓔ Button Color Code	Ⓕ Legend Code		
			Top Button	Bottom Button					
Momentary	Flush (top) Flush (bottom)		1NO	1NC	HW7D-B11F1001-ⒺⒻ	GR: Green (top) Red (bottom)	Blank: Without legend		
			1NO	1NO	HW7D-B11F1010-ⒺⒻ				
			1NO-1NC	1NO-1NC	HW7D-B11F1111-ⒺⒻ				
			2NO	2NC	HW7D-B11F2002-ⒺⒻ				
			2NO	2NO	HW7D-B11F2020-ⒺⒻ				
Momentary	Flush (top) Extended (bottom)		1NO	1NC	HW7D-B12F1001-ⒺⒻ				
			1NO	1NO	HW7D-B12F1010-ⒺⒻ				
			1NO-1NC	1NO-1NC	HW7D-B12F1111-ⒺⒻ				
			2NO	2NC	HW7D-B12F2002-ⒺⒻ				
			2NO	2NO	HW7D-B12F2020-ⒺⒻ				
Interlock*	Flush (top) Flush (bottom)		1NO	1NC	HW7D-B21F1001-ⒺⒻ			WB: White (top) Black (bottom)	1: I/ON (top) O/OFF (bottom)
			1NO	1NO	HW7D-B21F1010-ⒺⒻ				
			1NO-1NC	1NO-1NC	HW7D-B21F1111-ⒺⒻ				
			2NO	2NC	HW7D-B21F2002-ⒺⒻ				
			2NO	2NO	HW7D-B21F2020-ⒺⒻ				
	Interlock*	Flush (top) Extended (bottom)		1NO	1NC	HW7D-B22F1001-ⒺⒻ			
				1NO	1NO	HW7D-B22F1010-ⒺⒻ			
				1NO-1NC	1NO-1NC	HW7D-B22F1111-ⒺⒻ			
				2NO	2NC	HW7D-B22F2002-ⒺⒻ			
				2NO	2NO	HW7D-B22F2020-ⒺⒻ			

1. \*Interlock type prevents both top and bottom buttons from being pressed simultaneously.  
 2. Clear silicon rubber cover part number HW9Z-D7D.  
 3. Additional contact configurations available (up to 6 total contacts).

**With Center Pilot Light**

Operation Type	Button Style		Top Button	Bottom Button	Part Number
Momentary	Flush (Top) Flush (Bottom)	Flush (top) Flush (bottom)	1NO	1NC	HW7D-L11F1001②③-④⑤
			1NO	1NO	HW7D-L11F1010②③-④⑤
			1NO-1NC	1NO-1NC	HW7D-L11F1111②③-④⑤
			2NO	2NC	HW7D-L11F2002②③-④⑤
			2NO	2NO	HW7D-L11F2020②③-④⑤
	Flush (Top) Extended (Bottom)		1NO	1NC	HW7D-L12F1001②③-④⑤
			1NO	1NO	HW7D-L12F1010②③-④⑤
			1NO-1NC	1NO-1NC	HW7D-L12F1111②③-④⑤
			2NO	2NC	HW7D-L12F2002②③-④⑤
			2NO	2NO	HW7D-L12F2020②③-④⑤
Interlock*	Flush (Top) Flush (Bottom)	Flush (top) Extended (bottom)	1NO	1NC	HW7D-L21F1001②③-④⑤
			1NO	1NO	HW7D-L21F1010②③-④⑤
			1NO-1NC	1NO-1NC	HW7D-L21F1111②③-④⑤
			2NO	2NC	HW7D-L21F2002②③-④⑤
			2NO	2NO	HW7D-L21F2020②③-④⑤
	Flush (Top) Extended (Bottom)		1NO	1NC	HW7D-L22F1001②③-④⑤
			1NO	1NO	HW7D-L22F1010②③-④⑤
			1NO-1NC	1NO-1NC	HW7D-L22F1111②③-④⑤
			2NO	2NC	HW7D-L22F2002②③-④⑤
			2NO	2NO	HW7D-L22F2020②③-④⑤

- 1. \*Interlock type prevents both top and bottom buttons from being pressed simultaneously.
- 2. Clear silicon rubber cover part number HW9Z-D7D.
- 3. All assembled part numbers in catalog include standard (HW-F...) contacts.
- 4. Assembled units with spring-up terminals (HW-G...) can be ordered by removing an "F" from the part number (Ex. HW1B-M1F11-R becomes HW1B-M111-R).
- 5. Units with exposed screw terminals (HW-C...) must be ordered as sub-components.

**② Pilot Light Illumination & Voltage Code**

Full Voltage	
Voltage	Code
6V AC/DC, LED	Q2
12V AC/DC, LED	Q3
24V AC/DC, LED	Q4
120V AC, LED	Q8
6V AC/DC, Incandescent	Q5*
12V AC/DC, Incandescent	Q6*
24V AC/DC, Incandescent	Q7*

Step-Down Transformer (6V Secondary Lamp Voltage)	
Voltage	Code
120V AC, LED	H22
240V AC, LED	M42
480V AC, LED	T82
120V AC, Incandescent	H25*
240V AC, Incandescent	M45*
480V AC, Incandescent	T85*

 \*Only available for White Lens Pilot Lamp.

**③ Pilot Lamp Color Code**

Color	Code
Amber	A*
Green	G*
Red	R*
Blue	S*
White	W

 \*Only available in LED illumination.

**④ Pushbutton Color Code**

Color		Code
Top	Green	GR
Bottom	Red	
Top	White	WB
Bottom	Black	

**⑤ Engraving Codes**

Engraving		Code
No Engraving		Blank
I/ON	Top	1
O/OFF	Bottom	

Switches & Pilot Devices

Signaling Lights

Relays & Sockets

Timers

Contactors

Terminal Blocks

Circuit Breakers

Part Number Structure

H W 7 D - L 21 F 20 20 H22 R - GR 1

Pilot Light

B: Without Center Pilot Light  
L: With Center Pilot Light

Button Arrangement

11: Momentary (Flush/Flush)  
12: Momentary (Flush/Extended)  
21: Interlock (Flush/Flush)  
22: Interlock (Flush/Extended)

Contact Arrangement

**Top Button**  
01: 1NC 02: 2NC  
10: 1NO 20: 2NO  
**Bottom Button**  
01: 1NC 02: 2NC  
10: 1NO 20: 2NO

Voltage Code

blank: without center pilot light  
**Full Voltage\*** Q2: 6V LED  
**Transformer\*** H22: 120V AC LED  
\*For additional voltage codes, please see previous page

Pilot Lamp Color

A: Amber\* Y: Yellow\*  
G: Green\* blank: without center pilot light  
R: Red\* S: Blue\*  
W: White  
\*Only available in LED illumination.

Engraving Code

blank: No Engraving  
1: Top: I/ON  
Bottom: O/OFF

Pushbutton Color

GR: Top: Green  
Bottom: Red  
WB: Top: White  
Bottom: Black

Dual Pushbutton Switches (Sub-assembled) Part Numbers

Contact Blocks + Mounting Adaptor + Safety Lever Lock + Operator + Lens = Completed Unit



Lamp Circuit Components with Fingersafe Terminals

Style	Description	Part Number
Lead Holder	For use with HW-CBL on all illuminated pushbutton units. One required for each deck (pair) of contacts.	HW-LH3
Dummy Block with Full Voltage Adaptor	For use with odd number of contacts.	HW-DA1FB
Full Voltage Adaptor	For use with even number of contacts.	TW-DA1FB
Transformer Unit (6V secondary voltage)	120VAC 240VAC 480VAC	TW-F126B TW-F246B TW-F486B

Exposed and spring up terminals also available.

Operators

Style	Button	Part Number
Momentary	Flush (top)	HW7D-*11Ⓞ-Ⓞ
	Flush (bottom)	
	Flush (top)	HW7D-*12Ⓞ-Ⓞ
	Extended (bottom)	
Interlock	Flush (top)	HW7D-*21Ⓞ-Ⓞ
	Flush (bottom)	
	Flush (top)	HW7D-*22Ⓞ-Ⓞ
	Extended (bottom)	

Instead of \* insert:  
B: Non-illuminated  
L: Illuminated

Ⓞ Pushbutton Color Code

Color	Code	Color	Code
Top Green	GR	Top White	WB
Bottom Red		Bottom Black	

Contact Blocks

Style	Contacts	1NO	1NC	Style	Contacts	1NO	1NC
	Standard Fingersafe (IP20)	HW-F10 HW-F10R (early make)	HW-F01 HW-F01R (late break)		Spring-Up Terminal	HW-G10 HW-G10R (early make)	HW-G01 HW-G01R (late break)
	Dummy Block	TW-DB			Exposed Screw Terminal	HW-C10 HW-C10R (early make)	HW-C01 HW-C01R (late break)

Contact Block Mounting Adaptor

Style	Part Number
Non-illuminated	HW-CB2C
Illuminated (with Pilot Light)	HW-CBL

- Used to mount contact blocks to operator (first pair only).
- IEEC strongly recommends using the safety lever lock (included) to prevent heavy vibration or maintenance personnel from inadvertently unlocking contacts.

Safety Lever Lock

Style	Part Number
	HW9Z-LS

Anti-Rotation Ring

Appearance	Part Number
	HW9Z-RL

Use with notched panel cutout to prevent unit rotation.

Ⓞ Engraving Codes

Engraving	Code
No Engraving	Blank
I/ON	Top
O/OFF	Bottom

Lamps/Lens

Style	Voltage	Part Number
LED	6V AC/DC	LSTD-6Ⓞ
	12V AC/DC	LSTD-1Ⓞ
	24V AC/DC	LSTD-2Ⓞ
	120V AC	LSTD-H2Ⓞ
Incandescent	240V AC	LSTD-M4Ⓞ
	6V AC/DC	IS-6
	12V AC/DC	IS-12
Non-illuminated	24V AC/DC	IS-24
		HW9Z-B7B
Illuminated		HW9Z-L7W

- In place of Ⓞ, specify the LED Color Code.
- The LED contains a current-limiting resistor and reverse polarity protection diodes.

Ⓞ LED Color Code

Color	Code	Color	Code
Amber	A*	Blue	S*
Green	G*	White	W
Red	R*		

Only for LED illumination.

Contact Arrangement Chart

Contact Arrangement			Contact Block		Top Button		Bottom Button		
Top Button	Bottom Button	Contact Code	Mounting Position	Type	Normal	Push	Normal	Push	
1NO	1NO	1010	1	NO		X			
			2	NO				X	
1NO	1NC	1001	1	NO		X			
			2	NC			X		
1NC	1NO	0110	1	NC	X				
			2	NO				X	
1NC	1NC	0101	1	NC	X				
			2	NC			X		
1NO	2NO	1020	1	NO		X			
			2	NO				X	
			3	Dummy					
			4	NO					X
1NO	1NO-1NC	1011	1	NO		X			
			2	NO				X	
			3	Dummy					
			4	NC				X	
1NO	2NC	1002	1	NO		X			
			2	NC			X		
			3	Dummy					
			4	NC				X	
1NC	2NO	0120	1	NC	X				
			2	NO				X	
			3	Dummy					
			4	NO					X
1NC	1NO-1NC	0111	1	NC	X				
			2	NO				X	
			3	Dummy					
			4	NC				X	
1NC	2NC	0102	1	NC	X				
			2	NC			X		
			3	Dummy					
			4	NC				X	
2NO	1NO	2010	1	NO		X			
			2	NO				X	
			3	NO		X			
			4	Dummy					
2NO	1NC	2001	1	NO		X			
			2	NC			X		
			3	NO		X			
			4	Dummy					
1NO-1NC	1NO	1110	1	NO		X			
			2	NO				X	
			3	NC	X				
			4	Dummy					
1NO-1NC	1NC	1101	1	NO		X			
			2	NC			X		
			3	NC	X				
			4	Dummy					

Contact Block Mounting Position Example

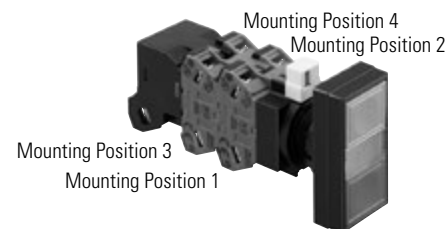

Switches & Pilot Devices

Signaling Lights

Relays & Sockets

Timers

Contactors

Terminal Blocks

Circuit Breakers

1. Transformers can have two or four contact blocks only.  
2. Contact blocks 1 and 3 are actuated by the top button. Contact blocks 2 and 4 are actuated by the bottom button.

Switches & Pilot Devices

Signaling Lights

Relays & Sockets

Timers

Contactors

Terminal Blocks

Circuit Breakers

**Contact Arrangement Chart (con't)**

Contact Arrangement			Contact Block		Top Button		Bottom Button	
Top Button	Bottom Button	Contact Code	Mounting Position	Type	Normal	Push	Normal	Push
2NC	1NO	0210	1	NC	X			
			2	NO			X	
			3	NC	X			
			4	Dummy				
2NC	1NC	0201	1	NC	X			
			2	NC			X	
			3	NC	X			
			4	Dummy				
2NO	2NO	2020	1	NO		X		
			2	NO				X
			3	NO		X		
			4	NO				X
2NO	1NO-1NC	2011	1	NO		X		
			2	NO				X
			3	NO		X		
			4	NC				X
2NO	2NC	2002	1	NO		X		
			2	NC				X
			3	NO		X		
			4	NC				X
1NO-1NC	2NO	1120	1	NO		X		
			2	NO				X
			3	NC	X			
			4	NO				X
1NO-1NC	1NO-1NC	1111	1	NO		X		
			2	NO				X
			3	NC	X			
			4	NC				X
1NO-1NC	2NC	1102	1	NO		X		
			2	NC				X
			3	NC	X			
			4	NC				X
2NC	2NO	0220	1	NC	X			
			2	NO				X
			3	NC	X			
			4	NO				X
2NC	1NO-1NC	0211	1	NC	X			
			2	NO				X
			3	NC	X			
			4	NC				X
2NC	2NC	0202	1	NC	X			
			2	NC				X
			3	NC	X			
			4	NC				X

**Contact Block Mounting Position Example**

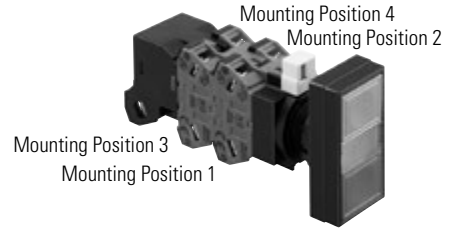



### Contactor Reset Button



#### Reset Buttons (Assembled)

	Plastic Bezel	Metal Bezel
(Blank)	HW1B-M1RS-⊙T	HW4B-M1RS-⊙T
Engraved "R"	HW1B-M1RS-⊙T-ENG-R	HW4B-M1RS-⊙T-ENG-R

-  1. In place of ⊙ specify Button Color Code.
- 2. 130mm (5.1") overall length.
- 3. 16mm flat base for easy alignment

#### ⊙ Button Color Code

Color	Code	Color	Code
Black	B	White	W
Green	G	Yellow	Y
Red	R	Gray	N
Blue	S		

#### Contactor Reset Button (Sub-assembled)

Rod	+	Operator	+	Button	=	Completed Unit
-----	---	----------	---	--------	---	----------------



#### Rod

Style	Part Number
	HW9Z-RS-TK2141

#### Button

Style	Part Number
	HW1A-B1-⊙

#### Operator

Style	Plastic	Metal
	HW1B-M0	HW4B-M0
		

-  In place of ⊙, specify the Button Color Code from table.

#### ⊙ Button Color Code

Color	Code	Color	Code
Black	B	White	W
Green	G	Yellow	Y
Red	R	Gray	N
Blue	S		

Nameplates - HW Series

	HWAM-Black Plastic	HWAQ-Black Plastic	HWAS-Black Plastic	HWAV-Yellow Plastic
Nameplate (blank engraving plate included)	HWAM-OB	HWAQ-OB	HWAS-OB	HWAV-0 HWAV5-0†
Nameplate (engraved)	HWAM-⓪	HWAQ-⓪	HWAS-⓪	HWAV-27* HWAV5-27†
Additional Insert (blank)	HWNP-0	HWNP-0	HWNP Dimensions	
Additional Insert (engraved)	HWNP-⓪	HWNP-⓪		

- 1. In place of ⓪, insert either the standard legend code from table below or custom engraving delimited by " ".
- 2. Standard engravings are available at no charge.
- 3. \* HWAV-27 comes engraved "Emergency Stop" as shown in drawing.
- 4. † HWAV5-27 and HWAV5-0 for 60mm diameter E-Stops (80mm diameter nameplate).

Standard Legend Codes

Pushbuttons				Pushbuttons/Selector Switches				Selector Switches	
Legend	Code	Legend	Code	Legend	Code	Legend	Code	Legend	Code
AUTO	101	OPEN	116	AUTO-MAN	201	REV-FOR	216	AUTO-MAN-OFF	301
CLOSE	102	OUT	117	CLOSE-OPEN	202	RUN-JOG	217	AUTO-OFF-MAN	302
DOWN	103	RAISE	118	DOWN-UP	203	RUN-SAFE	218	CLOSE-OFF-OPEN	303
EMERG.STOP	104	RESET	119	FAST-SLOW	204	SAFE-RUN	219	DOWN-OFF-SLOW	304
FAST	105	REVERSE	120	FOR-REV	205	SLOW-FAST	220	FAST-OFF-SLOW	305
FORWARD	106	RUN	121	HAND-AUTO	206	START-STOP	221	FOR-OFF-REV	306
HAND	107	SLOW	122	HIGH-LOW	207	STOP-START	222	LEFT-OFF-RIGHT	307
HIGH	108	START	123	JOG-RUN	208	UP-DOWN	223	LOWER-OFF-RAISE	308
IN	109	STOP	125	LEFT-RIGHT	209	OI (Int'l OFF ON)	250	OFF-MAN-AUTO	309
INCH	110	TEST	126	LOWER-RAISE	210			OFF-SLOW-FAST	310
JOG	111	UP	127	MAN-AUTO	211			OFF-1-2	311
LOW	112	I (Int'l On)	150	OFF-ON	212			OPEN-OFF-CLOSE	312
LOWER	113	O (Int'l Off)	151	ON-OFF	213			SLOW-OFF-FAST	313
OFF	114	EMO	152	OPEN-CLOSE	214			SUMMER-OFF-WINTER	314
ON	115			RAISE-LOWER	215			UP-OFF-DOWN	315
								1-OFF-2	316
								HAND-OFF-AUTO	317

- 1. To order engraved nameplates, add legend code to nameplate part number.
- 2. Character height based on the number of characters and size of nameplate. Standard character size is 3/16".
- 3. Nameplates with standard legends are the same list price as blank nameplates.
- 4. Nameplates have built-in anti-rotation feature for use with notched panel cut-outs. Additional anti-rotation ring (HW9Z-RL) is not necessary.

### Nameplates Order Form — HW Series

Copy this order form and use it to specify Letter Height, Custom Engravings, Location of Engraving on Nameplate, and Quantity Desired.

To ensure engraving accuracy, fax it to your IDEC representative or Distributor.

Your Company: \_\_\_\_\_  
 Name: \_\_\_\_\_  
 Telephone: \_\_\_\_\_  
 Fax & Email: \_\_\_\_\_

IDEC Rep/Distributor Contact: \_\_\_\_\_  
 PO number (if known): \_\_\_\_\_  
 IDEC Rep/Distributor Phone: \_\_\_\_\_  
 IDEC Rep/Distributor Fax & Email: \_\_\_\_\_

#### HWAM Nameplate

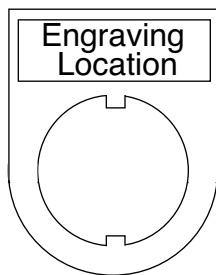

**Step 1.**  
**Choose Letter Size - 7/64" or 1/8".**  
 Check the box for the letter size you want. Then write your lettering in box below the check boxes. Note: 1/8" size letters cannot exceed 9 characters.

7/64" Letter Size  11 characters maximum (for 7/64" size letters)  
 1/8" Letter Size  9 characters maximum (for 7/8" size letters)

\_\_\_\_\_

1 2 3 4 5 6 7 8 9 10 11

**Step 2.**  
**Specify Quantity.**  
 Enter the number of nameplates desired in the box on the right.

Qty

Sample Letter Sizes  
 7/64" Letters: A B C D  
 1/8" Letters: A B C D

#### HWAQ Nameplate

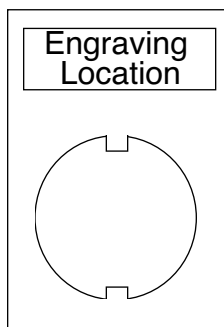

**Step 1.**  
**Choose Letter Size - 7/64" or 1/8".**  
 Check the box for the letter size you want. Then write your lettering in box below the check boxes. Note: 1/8" size letters cannot exceed 9 characters.

7/64" Letter Size  11 characters maximum (for 7/64" size letters)  
 1/8" Letter Size  9 characters maximum (for 7/8" size letters)

\_\_\_\_\_

1 2 3 4 5 6 7 8 9 10 11

**Step 2.**  
**Specify Quantity.**  
 Enter the number of nameplates desired in the box on the right.

Qty

Sample Letter Sizes  
 7/64" Letters: A B C D  
 1/8" Letters: A B C D

#### HWAS Nameplate

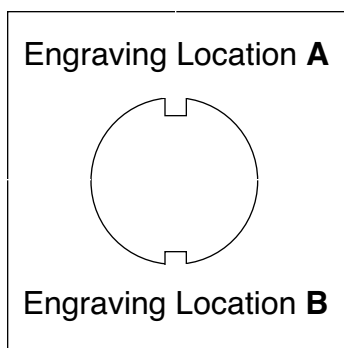

**Step 1.**  
**Choose Letter Size - 3/32" or 1/8".**  
 Check the box for the letter size you want. Then write your lettering in box below the check boxes. Note: 1/8" size letters cannot exceed 9 characters.

3/32" Letter Size  20 characters maximum (for 3/32" size letters)  
 1/8" Letter Size  14 characters maximum (for 7/8" size letters)

A \_\_\_\_\_

1 2 3 4 5 6 7 8 9 10 11 12 13 14 15 16 17 18 19 20

B \_\_\_\_\_

1 2 3 4 5 6 7 8 9 10 11 12 13 14 15 16 17 18 19 20

**Step 2.**  
**Specify Quantity.**  
 Enter the number of nameplates desired in the box on the right.

Qty

**Step 3.**  
**Specify Location.**  
 Enter the location of engraving (A or B or Both), in box on the right.

Location

Sample Letter Sizes  
 3/32" Letters: A B C D  
 1/8" Letters: A B C D

### Switch Engraving Order Form – HW Series

Copy this order form and use it to specify Letter Height, Maximum Number of Lines and Text to be engraved.

To ensure engraving accuracy, fax it to your IDEC representative or Distributor.

Your Company: \_\_\_\_\_  
 Name: \_\_\_\_\_  
 Address: \_\_\_\_\_  
 PO: \_\_\_\_\_

Telephone: \_\_\_\_\_  
 Fax: \_\_\_\_\_  
 Email: \_\_\_\_\_  
 Part Number to be Engraved: \_\_\_\_\_

Please check one of the boxes below to indicate your choice of engraving options:

ø29mm, ø40mm Mushroom Head

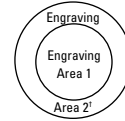

	# of Lines	Letter Height	Max. Characters Per Line
<input type="checkbox"/>	1	5/32	5
<input type="checkbox"/>		1/8	6
<input type="checkbox"/>	2	5/32	5
<input type="checkbox"/>		1/8	6
<input type="checkbox"/>	3	1/8	6
<input type="checkbox"/>	4	3/32	5

	# of Lines	Letter Height	Max. Characters Per Line
<input type="checkbox"/>	1	5/32	5
<input type="checkbox"/>		1/8	5
<input type="checkbox"/>	2	5/32	5
<input type="checkbox"/>		1/8	6
<input type="checkbox"/>	3	1/8	5
<input type="checkbox"/>	4	3/32	5

		# of Lines	Letter Height	Max. Characters Per Line
<input type="checkbox"/>	Engraving Area 1	1	5/32	5
<input type="checkbox"/>			1/8	5
<input type="checkbox"/>	Engraving Area 2	1	5/32	7
<input type="checkbox"/>			1/8	7



- Above mentioned specifications hold true for standard size pushbuttons (round and square).
- 'Engraving Area 2 can be engraved for 40mm mushroom Head non-Illuminated push button only.
- Engraving is done on the button itself for non-Illuminated push buttons and on marking plate for illuminated push buttons and pilot lights.
- Please enter text exactly how you want it engraved, take care to emphasize capital or small letters.

Enter text to be engraved:

Line 1: \_\_\_\_\_  
 Line 2: \_\_\_\_\_  
 Line 3: \_\_\_\_\_  
 Line 4: \_\_\_\_\_

#### Sample Letter Sizes

1/8 Letters: **OPEN**

5/32 Letters: **OPEN**

For IDEC Internal Use Only:

Work Order #: \_\_\_\_\_

Accessories

Item	Appearance	Description/Usage	Part Number	
Locking Ring Wrench		Metallic tool used to tighten the plastic locking ring when installing the HW series in a panel	MW9Z-T1	
Lamp/LED Removal Tool		Rubber tool makes lamp/LED removal easier.	OR-55	
Anti-Rotation Ring		Prevents rotation of switches in panel. (included with all assembled switches except pilot lights)	for notched panel cutout (standard)	HW9Z-RL
			for round panel cutout	LW9Z-L
Rubber Mounting Hole Plug		Black rubber plug fills unused 7/8" mounting holes in panel.	OB-31	
Metallic Mounting Hole Plug		For plugging unused 7/8" mounting holes in the panel. Tighten the attached locking ring to a torque of 12 kfg-cm maximum Degree of protection: IP66	LW9Z-BM	
Barrier		To prevent contact between adjacent lead wires when buttons or switches are tightly mounted close together.	HW-VL1	
Pushbutton Clear Boot		Used to cover and protect pushbuttons  Operating temperature: -50 to +60°C	Flush Pushbuttons	OC-31
			Extended Pushbuttons	OC-32
Padlock Cover		Plastic hinged padlockable cover to protect pushbuttons or selector switches. (Not intended for E-Stops)  Degree of protection: IP65	HW9Z-KL1	
Tab Terminal Adapter		Tab #250 (6.35 x 0.8mm): Single tab	TW-FA1	
Mounting Adaptor		Used to mount round HW series (except Jumbo Mushroom, unibody, and square units) into a larger panel cut-out. (includes both pieces)	22 to 30mm	HW9Z-A30
			22 to 25mm	HW9Z-A25
Replacement Safety Lever Lock		Used to prevent contact mounting lever from moving due to heavy vibration or panel maintenance.	HW9Z-LS	
Reset Rod for Contactors Overload		5" rod used with HW1B-M0.	HW9Z-RS-TK2141	
Replacement Operator Washer		Provided with operator. Insert between bezel and locking ring.	HWM-WASHER	
Replacement Locking Ring		Plastic locking nut comes with all HW operators & assemblies.	Standard (plastic)	HW9Z-LN
			Optional (metal)	HW9Z-LNM
Switch Cover (Square)		Used only with round or square flush pushbuttons.	HW9Z-K1 (spring return) HW9Z-K11 (maintained cover)	
Replacement Keys		Pair of Keys (#231)	HW9Z-SKP	

Switches & Pilot Devices

Signaling Lights

Relays & Sockets

Timers

Contactors

Terminal Blocks

Circuit Breakers

Switches & Pilot Devices

Signaling Lights

Relays & Sockets

Timers



Contactors



Terminal Blocks

Circuit Breakers

Item	Appearance	Description/Usage	Part Number
Replacement Lens		HW Illuminated Unibody Replacement Lens	HWLV-LENSR
Replacement Jumbo Dome Lens		Polycarbonate Replacement Lens (If using yellow lens, use white LED.)	HW1A-P5Ⓞ Ⓞ = (A, G, R, S, W, Y)
Replacement Jumbo LED Diffusing Lens			HW9Z-PP5C
Replacement LED Lamps for HW Jumbo Dome		Replacement LED Lamp - applicable for jumbo pilot lights only	LSTDB-2Ⓞ Ⓞ = (A, G, R, S, W)
Rubber Cover for Dual Pushbuttons		Clear Silicon rubber cover	HW9Z-D7D
Barrier for Dual Pushbuttons		Plastic barrier. Used when mounting the HW7 units on 30mm horizontal centers, to prevent possible interconnections between adjoining terminals.	HW-VG1
EMO Sticker		Emergency stop nameplate sticker	HW9Z-EMO-NP-TK2120

**E-Stop Shrouds**

Style	Part Numbers	E-Stop Types	Applicable Standards
	HW9Z-KG1	40mm Mushroom Head	SEMI S2-0703, 12.5.1 Compliant
	HW9Z-KG2	40mm, and 60mm Mushroom Head	SEMI S2-0703, 12.5.1 & SEMATECH Compliant

Style	Part Numbers	E-Stop Types	Applicable Standards
	HW9Z-KG3	40mm Mushroom Head	SEMI S2 Compliant (Approved by TUV)
	HW9Z-KG4	40mm Mushroom Head	SEMI S2 Compliant (Approved by TUV) & SEMATECH

**Contact Assemblies**

**Standard Contact Assemblies**

For use with Non-Illuminated Pushbuttons & E-Stops

Style	Contacts	Part Number
	1NO	HW-CBF10
	1NC	HW-CBF01
	1NO/1NC	HW-CBF11
	2NO	HW-CBF20
	2NC	HW-CBF02
	2NO/2NC	HW-CBF22
	1NO	HW-CB10
	1NC	HW-CB01
	1NO/1NC	HW-CB11
	2NO	HW-CB20
	2NC	HW-CB02
	2NO/2NC	HW-CB22

**Full Voltage Contact Assemblies**

For use with Illuminated Pushbuttons.

Style	Contacts	Part Number
	1NO	HW-FL10Q0
	2NO	HW-FL20Q0
	1NO/1NC	HW-FL11Q0
	1NC	HW-FL01Q0
	2NC	HW-FL02Q0



Order lamp separately.



Gold contact option is available for spring-up terminals. Add suffix "MAU" to end of part number. For example, HW-CB20 becomes HW-CB20-MAU.

## Transformer Contact Assemblies

For use with Illuminated Pushbuttons.

Style	Contacts	Part Number
120V AC with LED	1NO	HW-FL10H2-Ⓢ
	2NO	HW-FL20H2-Ⓢ
	1NC	HW-FL01H2-Ⓢ
	1NO/1NC	HW-FL11H2-Ⓢ
240V AC with LED	1NO	HW-FL10M4-Ⓢ
	2NO	HW-FL20M4-Ⓢ
	1NC	HW-FL01M4-Ⓢ
	1NO/1NC	HW-FL11M4-Ⓢ
480V AC with LED	1NO	HW-FL10T8-Ⓢ
	2NO	HW-FL20T8-Ⓢ
	1NC	HW-FL01T8-Ⓢ
	1NO/1NC	HW-FL11T8-Ⓢ
120V AC with Incandescent	1NO	HW-FL10H2
	2NO	HW-FL20H2
	1NC	HW-FL01H2
	1NO/1NC	HW-FL11H2
240V AC with Incandescent	1NO	HW-FL10M4
	2NO	HW-FL20M4
	1NC	HW-FL01M4
	1NO/1NC	HW-FL11M4



- In place of Ⓢ, specify the LED Color Code.  
Ⓢ = A, G, R, S, or W
- 6V LED or incandescent lamp included.

## Dimensions (mm)

### Non-Illuminated Pushbuttons

#### Flush (HW1B-M1, -A1)

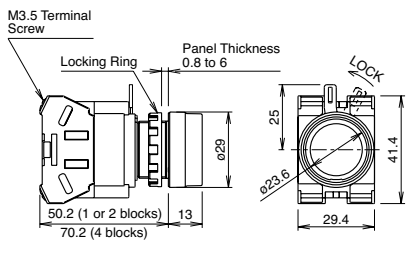

#### Extended (HW1B-M2, -A2)

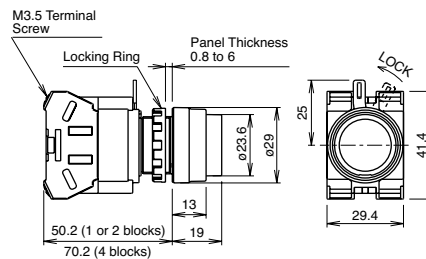

#### ø29mm Mushroom (HW1B-M3 -A3)

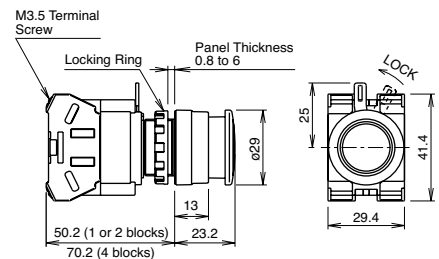

#### ø40mm Mushroom (HW1B-M4, -A4)

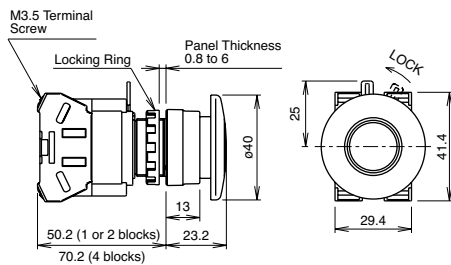

#### ø60mm Mushroom (HW1B-M5)

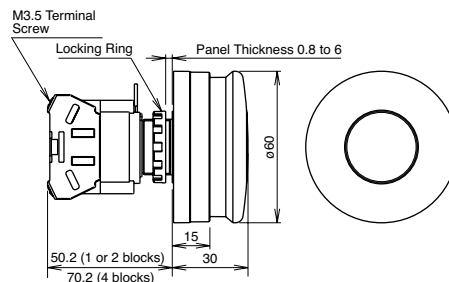

#### Square Flush (HW2B-M1, -A1)

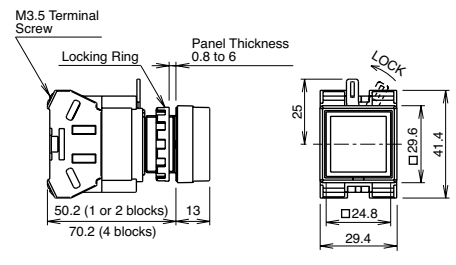

#### Square Extended (HW2B-M2, -A2)

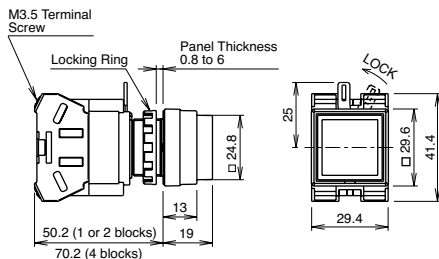

#### Contact Block (Bottom View)

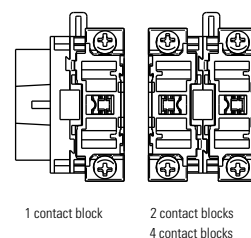

#### Terminal Wiring

Arrows indicate access directions for wiring

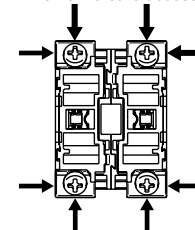



**Operators**

Dimensions (mm)

**Flush (Round & Square)**

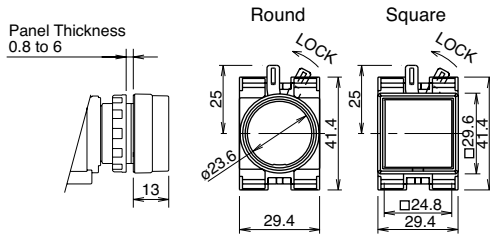

**Extended**

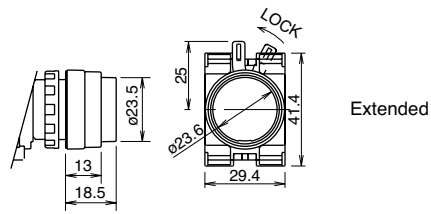

**Extended with Full Shroud**

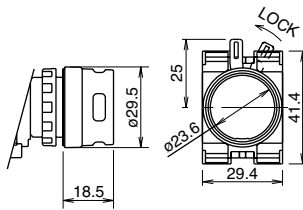

**ø40mm Mushroom**

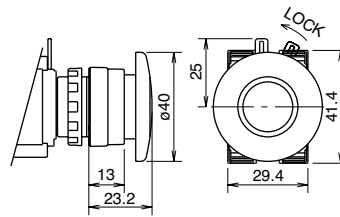

**Emergency Stop Pushbuttons**

Dimensions (mm)

**ø29mm Head Pushlock Turn Reset (HW1B-V3)**

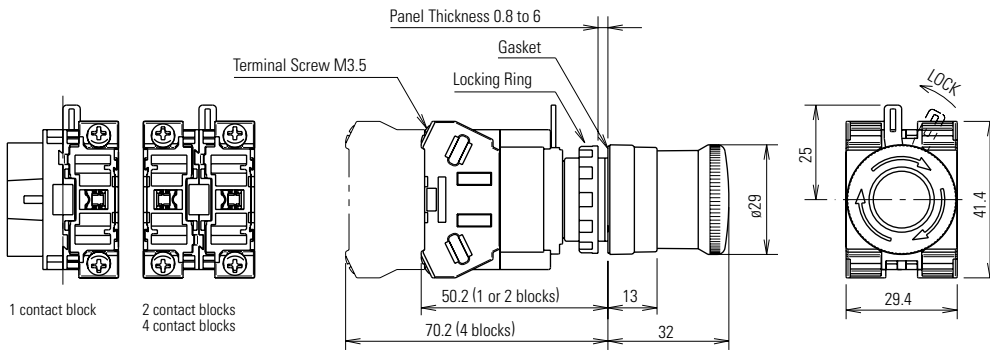

**ø40mm Head Pushlock Turn Reset (HW1B-V4)**

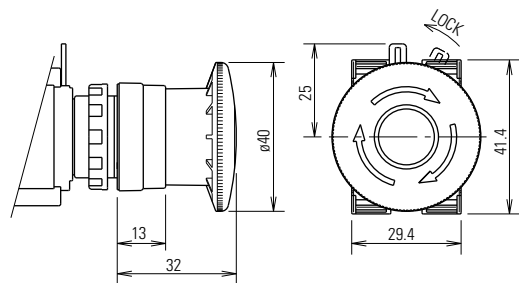

**ø40mm Head EMO Pushlock Turn Reset (HW1B-V4)**

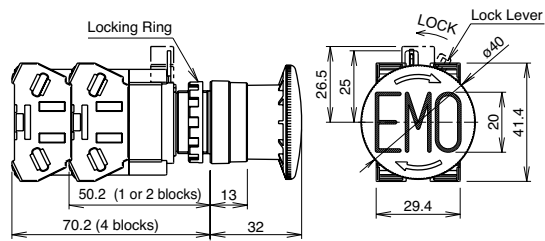

**ø40mm Head Pushlock Key Reset (HW1B-X4)**

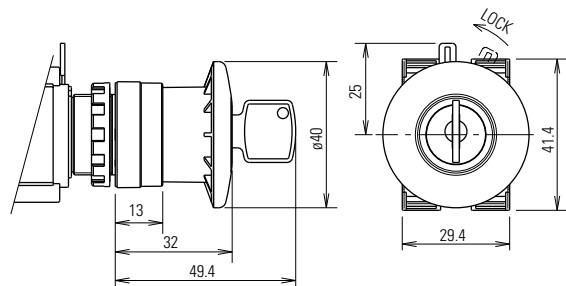

**ø60mm Head Pushlock Turn Reset (HW1B-V5)**

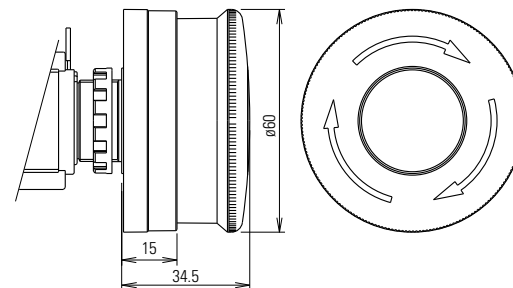

ø40mm Head Push-Pull (HW1B-Y2)

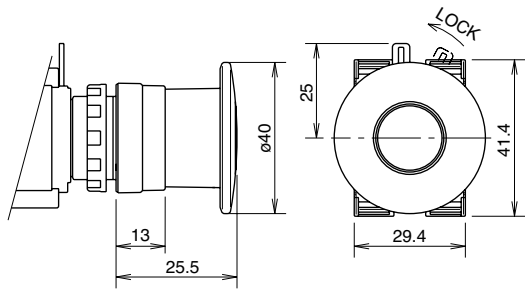

ø40mm Head Unibody Pushlock Turn Reset (HW1B-BV4)

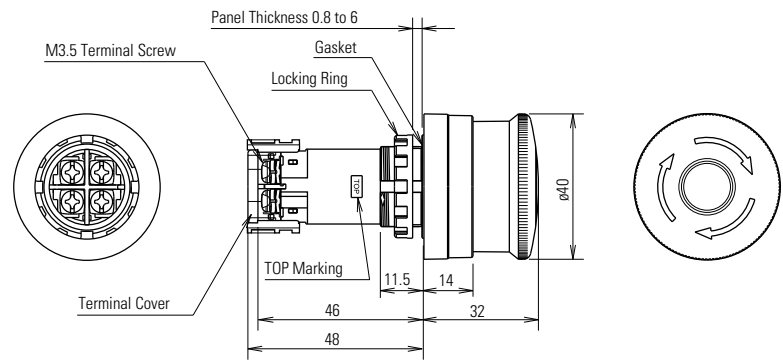

Illuminated E-Stop Pushbuttons (HW1E-LV4)

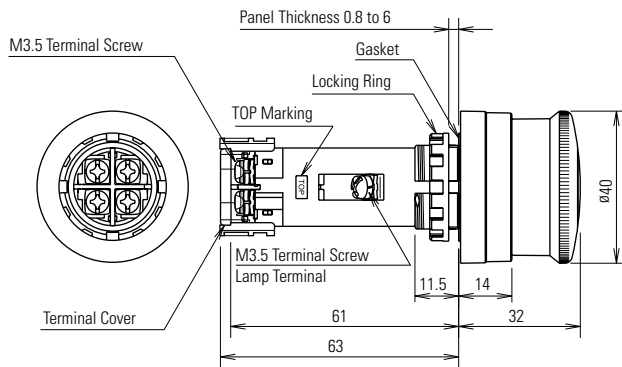

Mounting Hole

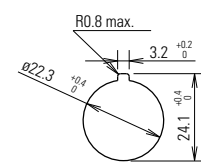

The minimum mounting centers shown below are applicable to E-Stop switches with one layer of contact blocks (two contact blocks). When two layers of contact blocks are mounted, determine the minimum mounting centers for ease of wiring.

Unit	Vertical Spacing	Horizontal Spacing
HW1B-V3 HW1B-V4 HW1B-X4 HW1B-Y2	50 mm	50 mm
HW1B-V5	60 mm	60 mm

Terminal Arrangement (Bottom View)

HW1E-BV4

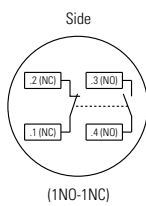

HW1E-LV4

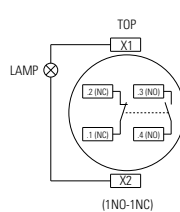

Emergency Stop Stations

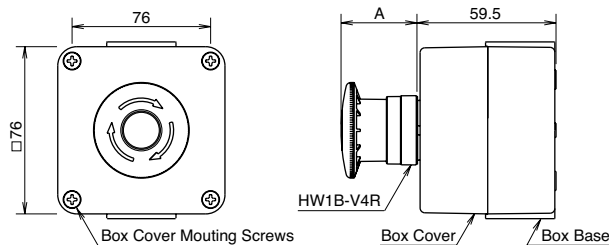

Operator	Dimension A (mm)
Pushlock Turn Reset	32
Pushlock Key Reset	32 (Key inserted: 49.4)
Push Pull	25.5

Dimensions (mm)

Mounting Hole Layout

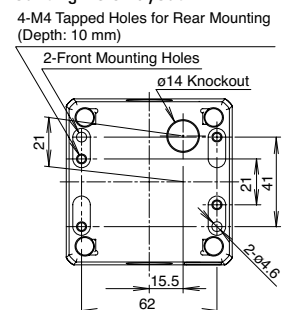

**Pilot Lights**

Full Voltage

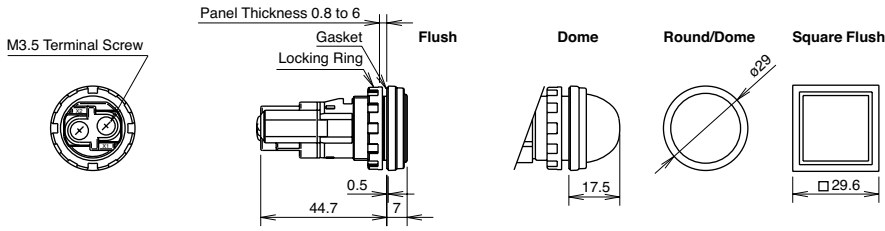

Transformer

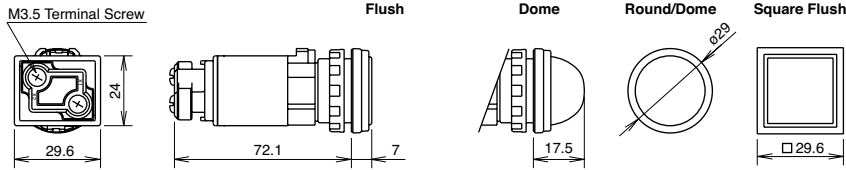

Mounting Hole Layout

Close mounting on 30mm centers  
Degree of protection: IP65

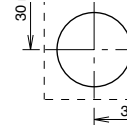

DC-DC Converter

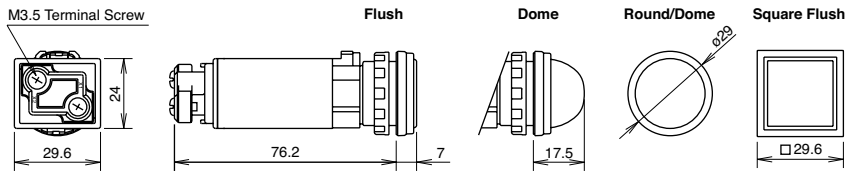

When mounting transformer or DC-DC converter type units on 30mm centers vertically and horizontally, keep the ambient temperature below 40°C.

**Jumbo Dome Pilot Lights**

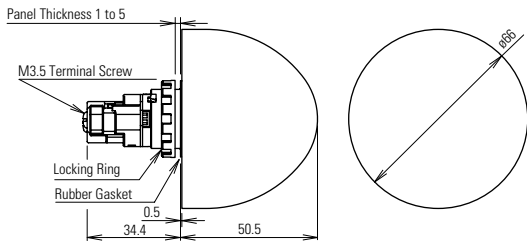

LED Lamp LSTDB

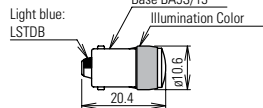

Incandescent Lamp LSB

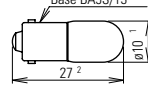

Mounting Hole Layout

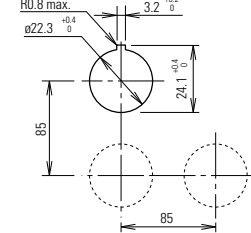

**Illuminated Pushbuttons**

Full Voltage Models

1 Contact Block

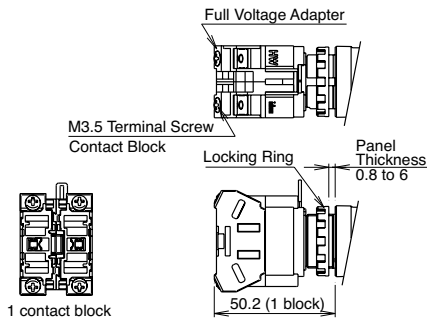

2 Contact Blocks

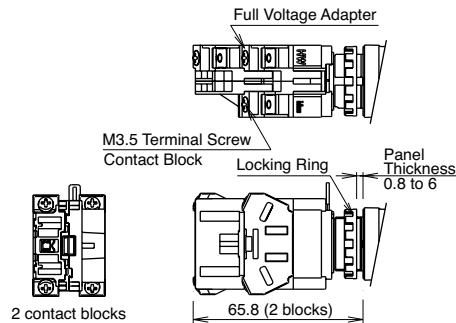

3 Contact Blocks

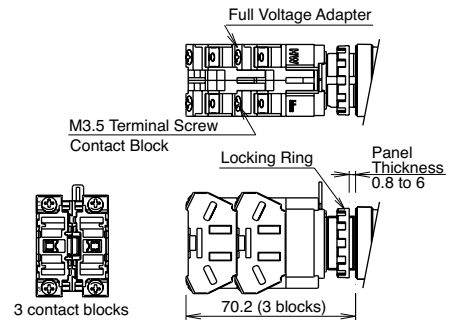

Dimensions (mm)

**Illuminated Pushbuttons con't**

4 Contact Blocks

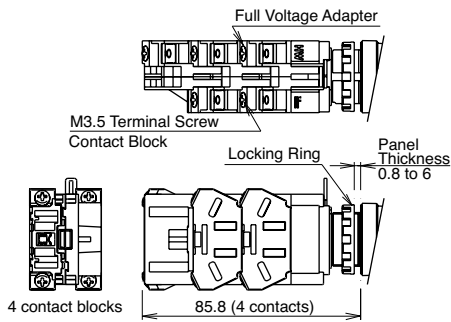

Terminal Wiring

Arrows indicate access directions for wiring.

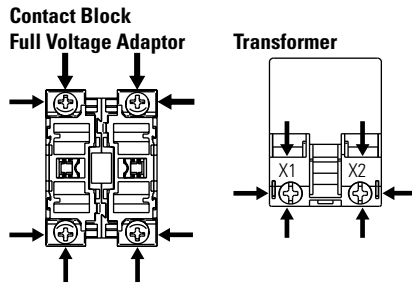

Transformer Models

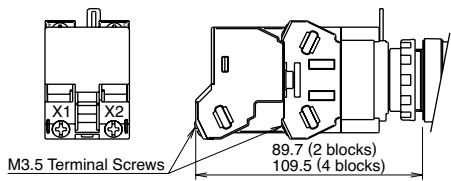

DC-DC Converter Models

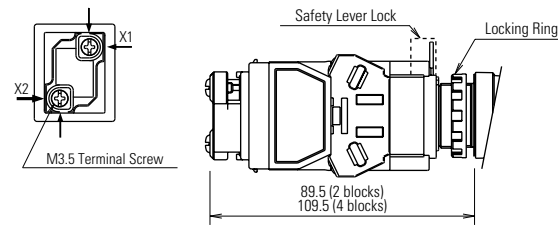

**Non-Illuminated Selector & Key Switches**

Dimensions (mm)

Knob Operator

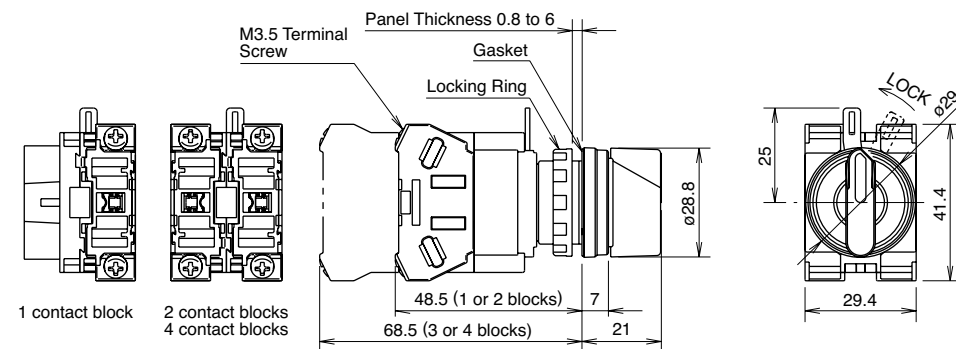

Terminal Wiring

Arrows indicate access directions for wiring.

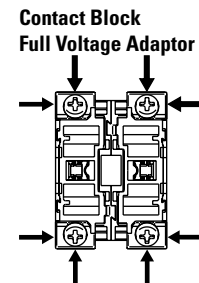

Key Operator

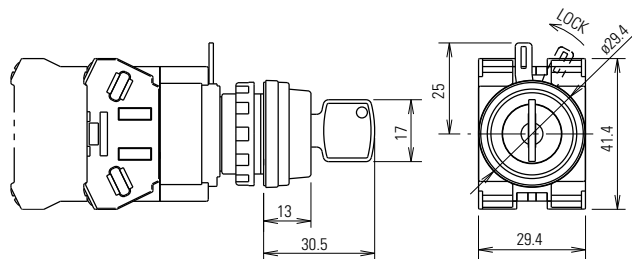

Transformer

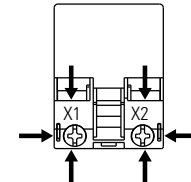

**Illuminated Selector Switches**

Full Voltage Model

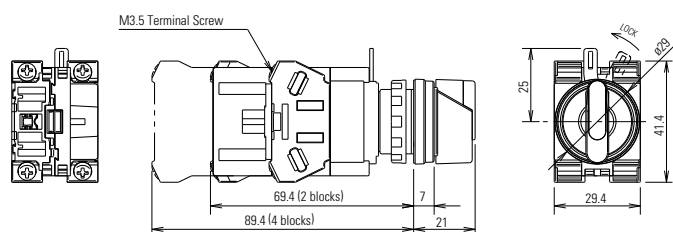

Transformer Model

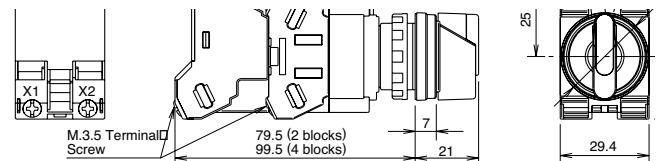

**Dual Pushbutton**

Without Pilot Light

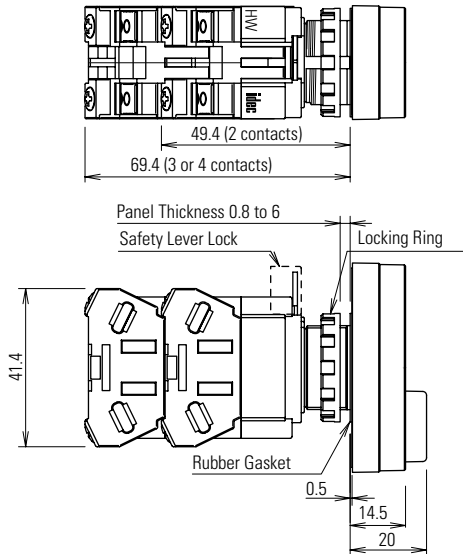

Without Button Markings

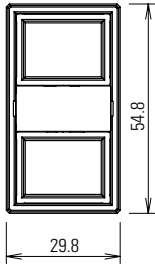

With Button Markings (I/ON and O/OFF)

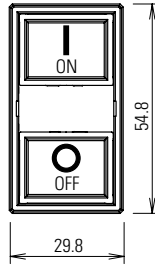

With Pilot Light

Full Voltage

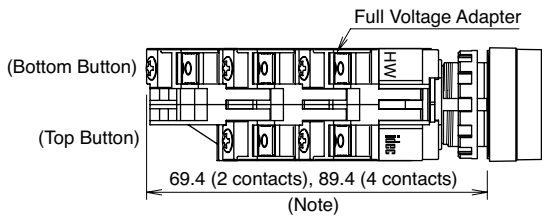

The depth of a 3-contact model depends on the combination of contact blocks at top and bottom pushbuttons.

Top Button	1 contact block	2 contact blocks
Bottom Button	2 contact blocks	1 contact block
Depth	89.4 mm	69.4 mm

Transformer (240V minimum)

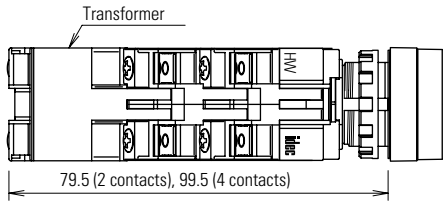

Transformer (480V)

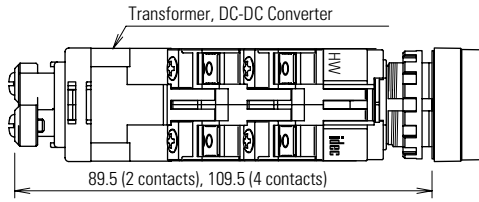

**Monolever**

Dimensions (mm)

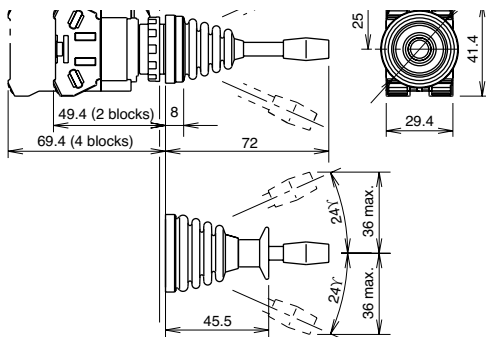

**Mounting Hole Layout**

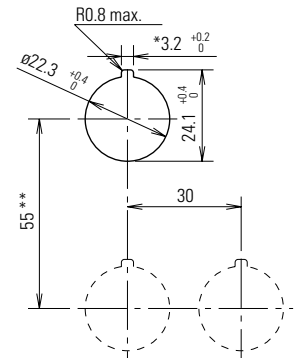

-The 3.2 mm recess is for preventing rotation and is not necessary when a nameplate or anti-rotation ring is not used.

-When using the safety lever lock, determine the vertical spacing in consideration of convenience for installing and removing the safety lever lock.

-Recommended vertical spacing: 100 mm  
-The minimum mounting centers are applicable to switches with one layer of contact blocks (two contact blocks). When two layers of contact blocks are mounted, determine the minimum mounting centers for ease of wiring.

Accessory Dimensions

**LW9Z-BM**  
Metallic Mounting Hole Plug

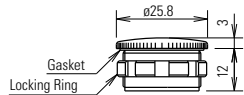

**OB-31**  
Rubber Mounting Hole Plug

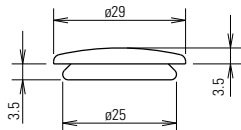

**HW9Z-RL**  
Anti-Rotation Ring

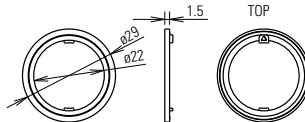

**OR-55**  
Lamp/LED Removal Tool

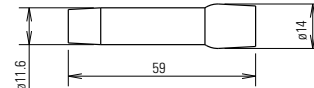

**HW9Z-D7D**  
Dual Pushbutton Rubber Cover

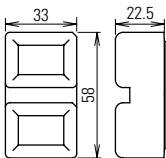

**HW-VG1**  
Dual Pushbutton Barrier

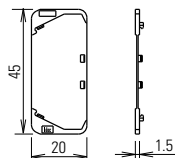

**MW9Z-T1**  
Locking Ring Wrench

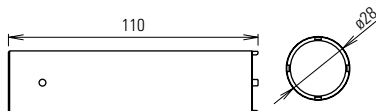

**HW-VL1**  
Barrier

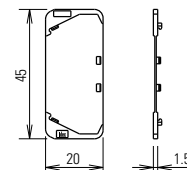

**HW9Z-KL1**  
Padlock Cover

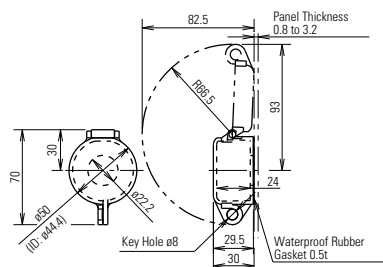

**HWLS-TK1971**  
Safety Lever Lock

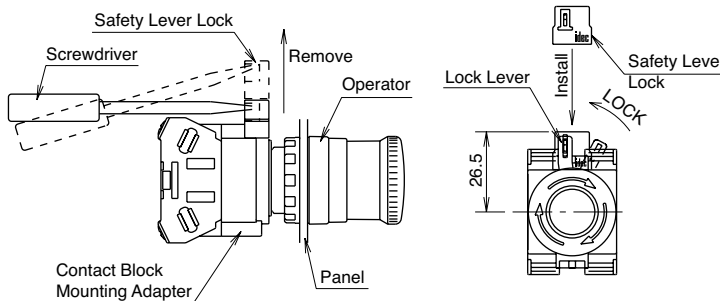

**HW9Z-KG1**

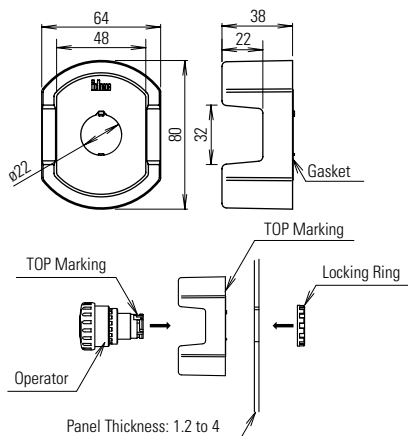

**HW9Z-KG2**

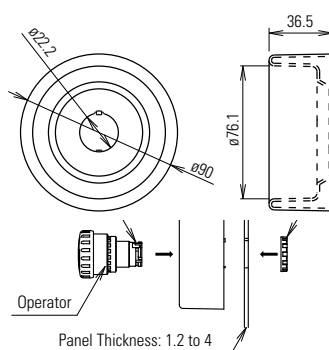

**HW9Z-KG3**

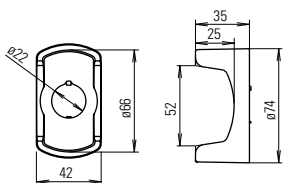

**HW9Z-KG4**

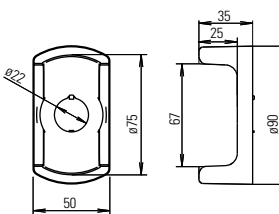

**LSTD**

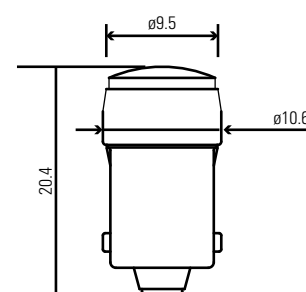

Specification Charts

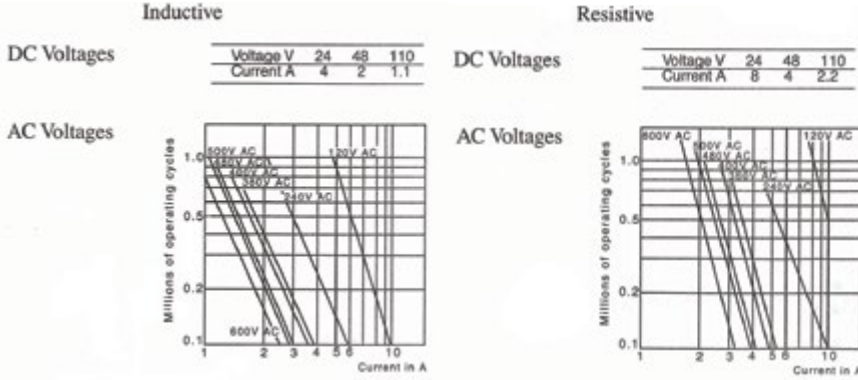

Conforming to IED 947-5-1 Appendix C.  
Utilization categories AC-15 and DC-13.  
Operation rate: 1,800 op. hour  
Load factor:  
Inductive 0.4 ± 0.05  
Resistive 0.9 ± 0.05

Operator Truth Tables

2 Position Selector Switches

	Contact	Mounting Position	Operator Position	
			Left	Right
			HW1S-2T HW1K-2* HW1F-2	HW-F10 (NO)
	HW-F01 (NC)	L: X, R: X	0, 0	
	HW-F10R (NO-EM)	L: 0, R: 0	X, X	
	HW-F01R (NC-LB)	L: X, R: X	0, 0	

3 Position Selector Switches con't

	Contact	Mounting Position	Operator Position		
			Left	Center	Right
			HW1S-3JT HW1K-3J*	HW-F10 (NO)	L: X, R: 0
	HW-F01 (NC)	L: 0, R: 0	X, X	0, 0	
	HW-FC10R (NO-EM)	L: X, R: X	0, 0	X, X	
	HW-F01R (NC-LB)	L: 0, R: X	X, X	X, 0	

3 Position Selector Switches

	Contact	Mounting Position	Operator Position		
			Left	Center	Right
			HW1S-3T HW1K-3* HW1F-3	HW-F10 (NO)	L: X, R: 0
	HW-F01 (NC)	L: 0, R: X	X, X	0, 0	
	HW-F10R (NO-EM)	L: X, R: 0	0, 0	X, X	
	HW-F01R (NC-LB)	L: 0, R: X	X, X	0, 0	

4 Position Selector Switches

	Contact	Mounting Position	Operator Position			
			1	2	3	4
			HW1S-4T	HW-F10 (NO)	L: X, R: 0	0, 0
	HW-F01 (NC)	L: 0, R: 0	0, X	0, 0	0, 0	
	HW-F10R (NO-EM)	L: X, R: X	X, 0	0, X	X, X	
	HW-F01R (NC-LB)	L: 0, R: X	0, X	X, X	X, 0	

5 Position Selector Switches

	Contact	Mounting Position	Operator Position				
			1	2	3	4	5
			HW1S-5T	HW-F10 (NO)	L: X, R: 0	0, 0	0, 0
	HW-F01 (NC)	L: 0, R: 0	0, 0	0, X	0, 0	0, 0	
	HW-F10R (NO-EM)	L: X, R: X	X, X	X, 0	0, X	X, X	
	HW-F01R (NC-LB)	L: 0, R: X	0, X	X, X	X, X	X, 0	

1. Mounting position indicates which side of operator each contact should be mounted (as viewed from the front of the panel).  
2. \*For key removable code see page 629.

3. HW1S-3T is identified by white plungers on the operator.  
4. HW1S-3ST is identified by red plungers on the operator.  
5. HW1S-3JT is identified by black plungers on the operator.



## HW Safety Precautions

Turn off power to HW series control units before starting installation, removal, wiring, maintenance, and inspection of the products. Failure to turn power off may cause electrical shocks or fire hazard.

To avoid the possibility of burning yourself, use the lamp holder tool when replacing lamps.

For wiring, use wires of a proper size to meet voltage and current requirements. Tighten the M3.5 terminal screws to a tightening torque of 1.0 to 1.3 N·m. Failure to tighten terminal screws may cause overheating and fire.

## HW General Instructions

### Panel Mounting

Remove the contact block assembly from the operator (for transformer type pilot lights, remove the transformer from the illumination unit). Remove the locking ring from the operator. Insert the operator into the panel cut-out from the front, tighten the locking ring from the back, then install the contact block assembly to the operator.

### Removing and Installing the Contact Block Assembly

1. To remove the operator from the contact block, turn the locking lever in the direction of the arrow shown below. The operator can now be removed.
2. To reinstall, place the TOP markings on the operator and the contact block mounting adapter in the same direction, and insert the operator into the contact block mounting adapter. Then turn the locking lever in the opposite direction.

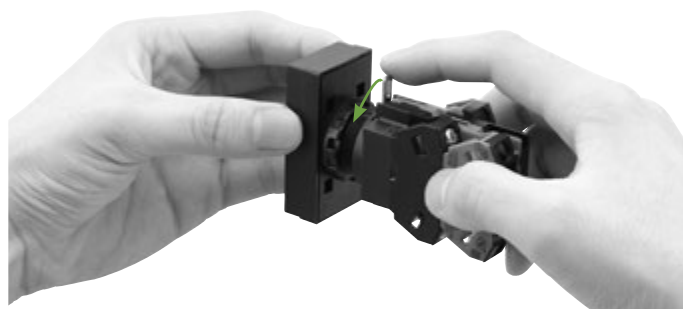

### Notes for Panel Mounting

1. When mounting the operator onto a panel, use the optional locking ring wrench (MW9Z-T1) to tighten the locking ring. Tightening torque must not exceed 2.0 N·m. Do not use pliers. Excessive tightening will damage the locking ring.
2. For the contact blocks and transformers housing LED and incandescent lamps, make sure not to press the lamps too hard, otherwise the lamp socket may be damaged.

### Safety Lever Lock

IDEC strongly recommends using the safety lever lock (HW9Z-LS, yellow) to prevent heavy vibration or maintenance personnel from unlocking the contact assembly.

1. HW series can be mounted vertically with a minimum spacing of 55 mm but spacing should be determined to ensure easy operation (recommended minimum spacing: 100 mm).
2. Mount the control unit onto the panel, lock the lever, and push in the safety lever lock to install.
3. When the spacing is narrower than the recommended value, with the lever unlocked, mount the safety lever lock and insert the contact unit to the operator. Then, lock the lever and strongly push in the safety lever lock to install.
4. To remove the safety lever lock, insert a flat screwdriver into the safety lever and push upwards.

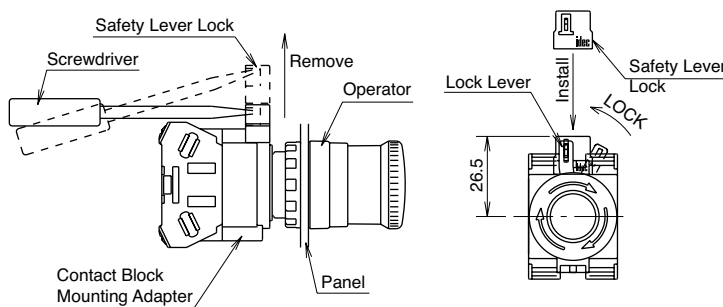

## Dual Pushbutton Instructions

### Replacement of Lens

#### Removing

Remove the lens by inserting a screwdriver into the recess of the lens through the bezel.

#### Installing

Install the lens in the recess between the buttons by pressing against the bezel.

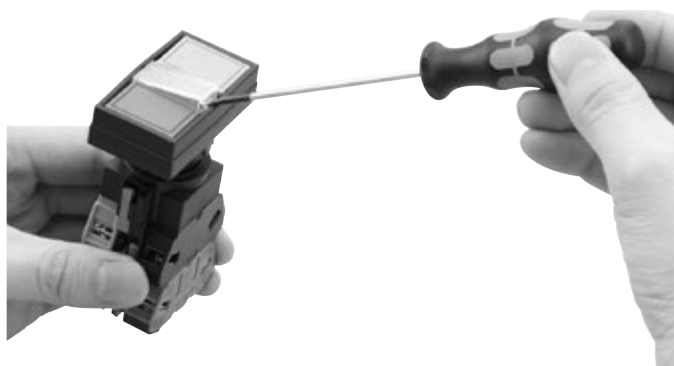

## Dual Pushbuttons Instructions con't

### Replacement of Lamps

Lamps can be replaced by using the lamp holder tool (OR-55) from the front of the panel, or by removing the contact block assembly from the operator unit.

### Removing the Lamps from the Front of the Panel

#### Removal

1. To remove, slip the lamp holder tool onto the lamp head lightly. Then push slightly, and turn the lamp holder tool counterclockwise.



#### Installation

1. To install, insert the lamp head into the lamp holder tool, and hold the lamp as shown in the figure below.
2. Place the pins on the lamp base to the grooves in the lamp socket. Insert the lamp and turn it clockwise.

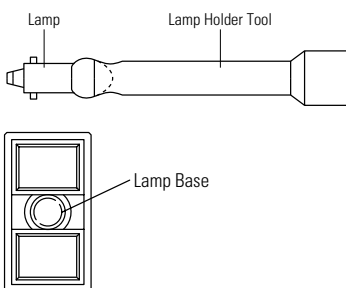

### About Pushbutton Switches

The pushbuttons cannot be removed or replaced!

Do not attempt to remove using a flat screwdriver or pliers, otherwise the pushbuttons may be damaged.

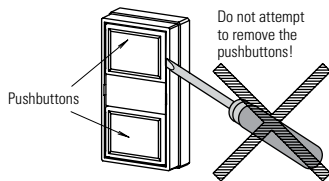

### Narrow Mounting

When mounting the units closely in a horizontal row on 30mm centers, use optional barriers to prevent interconnection between adjoining terminals. The barriers can be attached simply by pressing them onto the sides of contact blocks.



When mounting transformer type illuminated units closely in a horizontal row on 30-mm centers, insert solid wires or stranded wires into inside of the terminal screw on the transformer (see figure on the right) to prevent short circuit between adjoining terminals.

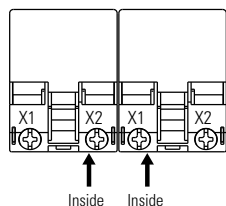

### Tightening Torque for Terminal Screws

Tighten the M3.5 terminal screws to a torque of 1.0 to 1.3 N·m.

### Installation of LED Illuminated Units

When using full voltage type LED illuminated units, provide protection against electrical noise, if necessary.

### Applicable Wiring

The applicable wire size is 2 mm<sup>2</sup> maximum. (solid wire ø1.6mm<sup>2</sup> maximum) One or two wires can be connected.

### Applicable Crimping Terminal

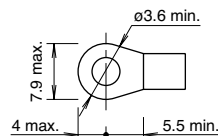

Be sure to use an insulation tube or cover on the crimping part of the crimping terminal to prevent electrical shocks.

### Solid Wire

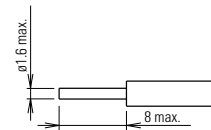

Note: When connecting wires to contact blocks or transformers in the direction shown below, keep the insulation stripping length 6.6 mm at the maximum.

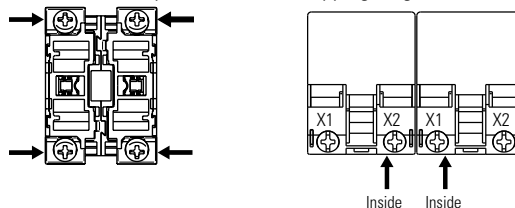

### Installing the Rubber Cover

When using the HW7D pushbuttons in places where the pushbuttons are subjected to water splash or an excessive amount of dust, make sure to use the HW9Z-D7D rubber boot (IP65) which is ordered separately.

### Notes for Installing the Rubber Cover

Remove the gasket from the operator, and install the rubber boot on the operator. Pull out the seals of the rubber boot and place them around the operator sleeve as shown. Make sure that the seals are not twisted or tucked inside and that the gasket does not remain, otherwise the normal waterproof and dustproof characteristics are not ensured.

1. Remove the gasket.
2. Install the rubber boot on the pushbuttons.
3. Rubber boot is installed.

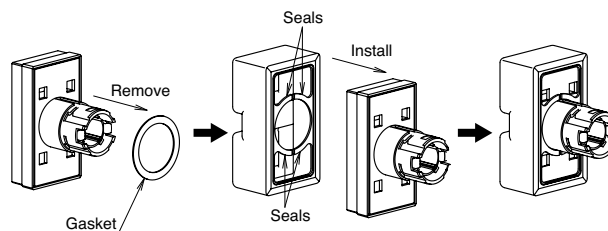

## TW Series – 22mm NEMA Style Pushbuttons

**Key features:**

- TW NEMA Style Switches with snap-on contacts
- Corrosion resistant octagonal chrome plated locking bezel
- Snap-on 10A contact blocks
- Incandescent or LED illumination
- Slow make, double break, self cleaning contacts
- Modular construction for maximum flexibility
- NEMA 4X and IP65 watertight/oiltight panel
- Available assembled or as sub-components
- Large M3.5 screw terminals with captive sems plate

IDEC has your 22mm switching needs covered.

Button styles include flush, extended, mushroom, or square and all bodies are crafted from fracture-resistant nylon.

All illuminated units feature two lens styles, one that maximizes light dispersion, the other accommodates direct lens engraving.

Self cleaning contact mechanisms allow for a wide current rating, 5mA to 10A, which reduces the need for various contact materials.

When looking for a 22mm switch that is durable, easy to use, and versatile, then IDEC's TW series is your solution.



UL Listed  
File No. E68961



CSA Approved  
File No. LR21451



File No. DK95-01696



Conforming to Standards		EN60947-1, EN60947-5-1, VDE0660-200, UL508, CSA C22-2 No.14
Approvals		
  		
File No. E68961    File No. LR21451    Certificate No. 2030010305027380		
 		
Registration No: J9551802 (E-Stops) Registration No: J9551803 (All other switches) Registration No: J9551804 (Pilot Lights)		<p><b>CSA:</b> pushbuttons and selector switches: A600 pilot lights and illuminated pushbuttons, direct supply pilot lights and illuminated pushbuttons with integral transformer (100/110, 115, 120, 200/220, 230, 240, 380, 400/440, 480V)</p> <p><b>UL:</b> pushbuttons and selector switches: A600 pilot lights and illuminated pushbuttons, direct supply pilot lights and illuminated pushbuttons with integral transformer (100/110, 115, 120, 200/220, 230, 240, 380, 400/440, 480V)</p> <p><b>TÜV:</b> pushbuttons and selector switches: A600=P600 (NO, NC)/Q600 (NO-EM, NC-LB) pilot lights and illuminated pushbuttons, direct supply pilot lights and illuminated pushbuttons with integral transformer (100/110, 115, 120, 200/220, 230, 240, 380, 400/440, 480V)</p>
Operating Temperature		Operation: -25 to +50°C (without freezing), Storage: -40 to +80°C (without freezing)
Vibration Resistance		5 to 55Hz, 100m/sec <sup>2</sup> (10g) conforming to IEC6068-2-6
Shock Resistance		1000m/sec <sup>2</sup> (100g) conforming to IEC6068-2-7
Electric Shock Protection		Class 0 conforming to IEC60536
Degree of Protection (conforming to IEC60529) (conforming to NEMA ICS6-110)		IP65 from front of the panel; (IP54 for key switches) IP20 (Type HW-F contact block) Type 1, 2, 3, 3R, 3S, 4, 4X, 5, 12, 13 (Type 1, 2, 3R, 5, 12, 13 for key switches)
Mechanical Life		Momentary pushbuttons: 5,000,000 (900 operations per hour) All other switches: 500,000
Pollution Degree (conforming to IEC60947-1)		3 for switches not using a transformer, 2 for switches using a transformer
Rated Operational Characteristics		AC-15: A600 or Ue = 250V, Ie = 3A (NO, NC, NO-EM, NC-LB) DC-13: P600 or Ue = 125V, Ie = 1.1A (NO, NC) DC-13: Q600 or Ue = 125V, Ie = 0.9A (NO-EM, NC-LB)
Rated Insulation Voltage		600V
Rated Switching Over-Voltage		Less than 4kV, conforming to IEC60947-1
Rated Impulse Withstanding Voltage		4kV for contact circuit, 2.5kV for lamp circuit
Rated Thermal Current		10 Amp
Minimum Switching Capacity		5 mA at 3V AC/DC
Contact Operation		Slow break NC or slow make NO, self-cleaning
Recommended Terminal Torque		0.8 N m (7.1 in lb.)
External Short-Circuit Protection		10A 250V fuse conforming to IEC60269-1
Applicable Wire Size		Minimum 1 x 22 AWG, max. 2 x 14 AWG or 1 x 12 AWG
Contact Resistance		Initial contact resistance of 50mΩ or less
Contact Gap		4mm (NO and NC), 2mm (NO-EM and NC-LB)
Electrical Reliability		MTBF < 1 fault for 10 million operation cycles (3V DC, 5mA)
Lamp Ratings		Incandescent: 1 W LEDs: 6V: 17mA max, 12/24V: 11mA max, 120/240V: 10mA max
Horsepower Rating		1/4 HP @ 120V (single-phase, non-reversing motor); 1 HP @ 240V (3 phase, non-reversing motor)
Maximum Inrush Current		40 A (40 ms)
Contact Material		Silver

Contact Ratings	Pushbuttons	Contact Block	Type HW-C/HW-F
	Illuminated Pushbuttons	Rated Insulation Voltage	600V
	Selector Switches	Rated Continuous Current	10A
	Illuminated Selector Switches	Contact Ratings by Utilization Category	AC-15 (A600) DC-13 (P600)
	Pushbutton Selectors	IEC 60947-5-1	

		Contact Ratings by Utilization Category							
Characteristics	Operational Voltage								
		24V	48V	50V	110V	220V	440V		
	Operational Current	AC50/60Hz	AC-12 Control of resistive loads and solid state loads	10A	—	10A	10A	6A	2A
			AC-15 Control of electromagnetic loads (> 72VA)	10A	—	7A	5A	3A	1A
		DC	DC-12 Control of resistive loads and solid state loads	8A	5A	—	2.2A	1.1A	—
DC-13 Control of electromagnets			5A	2A	—	1.1A	0.6A	—	

Non-Illuminated Pushbuttons (Assembled)

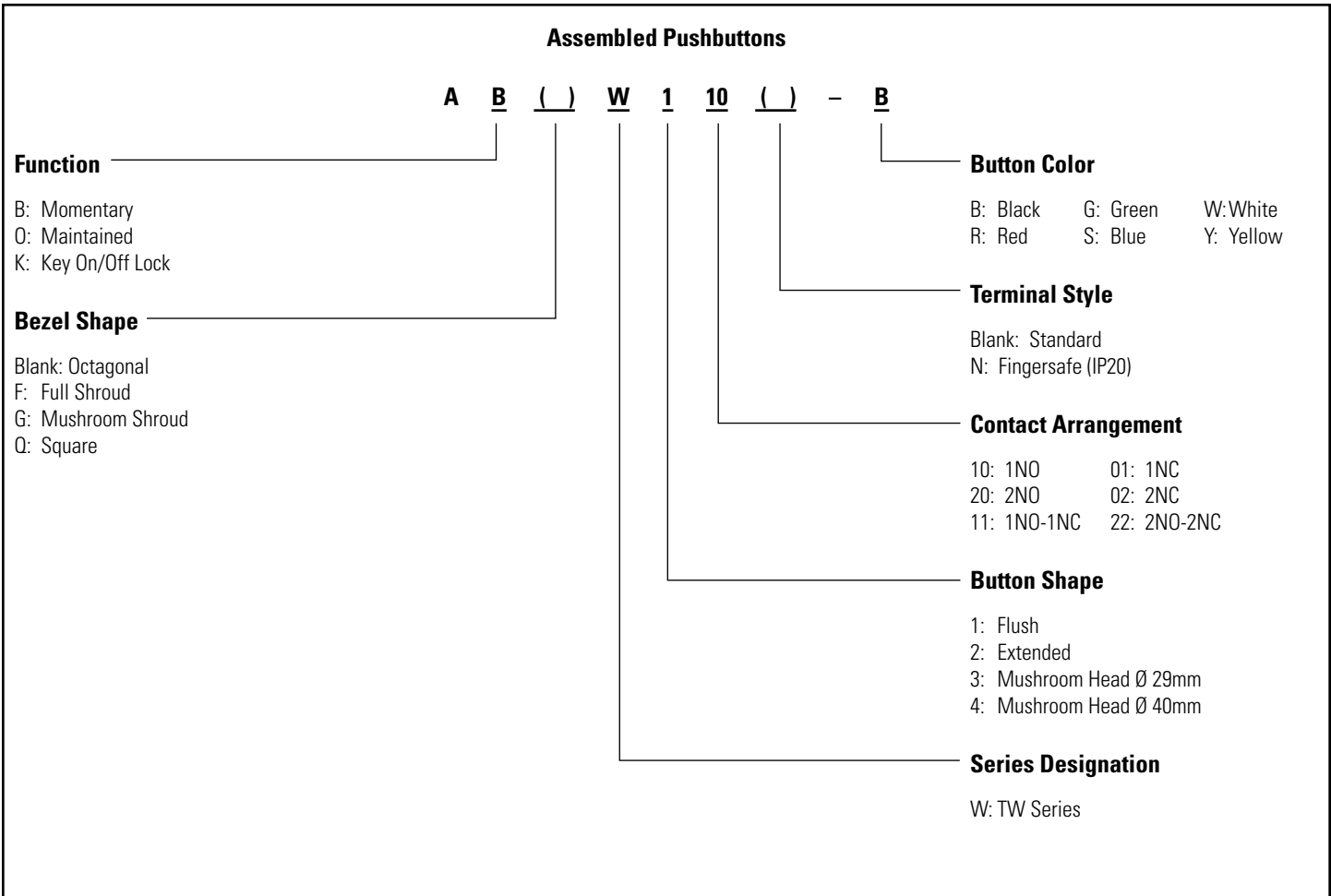

To be used for interpreting part numbers only, not for part number development.

Non-Illuminated Pushbuttons (Assembled) continued

Non-Illuminated Pushbuttons

① Button Color Codes

Style	Contacts	Momentary Action	Maintained Action
Flush	1NO	ABW110-①	AOW110-①
	1NC	ABW101-①	AOW101-①
	1NO-1NC	ABW111-①	AOW111-①
	2NO	ABW120-①	AOW120-①
	2NC	ABW102-①	AOW102-①
Extended	1NO	ABW210-①	AOW210-①
	1NC	ABW201-①	AOW201-①
	1NO-1NC	ABW211-①	AOW211-①
	2NO	ABW220-①	AOW220-①
	2NC	ABW202-①	AOW202-①
Recessed	1NO	ABFW110-①	AOFW110-①
	1NC	ABFW101-①	AOFW101-①
	1NO-1NC	ABFW111-①	AOFW111-①
	2NO	ABFW120-①	AOFW120-①
	2NC	ABFW102-①	AOFW102-①
Extended with Full Shroud	1NO	ABFW210-①	AOFW210-①
	1NC	ABFW201-①	AOFW201-①
	1NO-1NC	ABFW211-①	AOFW211-①
	2NO	ABFW220-①	AOFW220-①
	2NC	ABFW202-①	AOFW202-①
Ø 29mm Mushroom Head	1NO	ABW310-①	AOW310-①
	1NC	ABW301-①	AOW301-①
	1NO-1NC	ABW311-①	AOW311-①
	2NO	ABW320-①	AOW320-①
	2NC	ABW302-①	AOW302-①
Ø 40mm Mushroom Head	1NO	ABW410-①	AOW410-①
	1NC	ABW401-①	AOW401-①
	1NO-1NC	ABW411-①	AOW411-①
	2NO	ABW420-①	AOW420-①
	2NC	ABW402-①	AOW402-①
Ø 40mm Mushroom Head with Full Shroud	1NO	ABGW410-①	AOGW410-①
	1NC	ABGW401-①	AOGW401-①
	1NO-1NC	ABGW411-①	AOGW411-①
	2NO	ABGW420-①	AOGW420-①
	2NC	ABGW402-①	AOGW402-①
Square Flush	1NO	ABQW110-①	AQQW110-①
	1NC	ABQW101-①	AQQW101-①
	1NO-1NC	ABQW111-①	AQQW111-①
	2NO	ABQW120-①	AQQW120-①
	2NC	ABQW102-①	AQQW102-①
Square Extended	1NO	ABQW210-①	AQQW210-①
	1NC	ABQW201-①	AQQW201-①
	1NO-1NC	ABQW211-①	AQQW211-①
	2NO	ABQW220-①	AQQW220-①
	2NC	ABQW202-①	AQQW202-①
Keylock Push On/ Off	1NO	AKW210	—
	1NC	AKW201	—
	1NO-1NC	AKW211	—
	2NO	AKW220	—
	2NC	AKW202	—

Color	Code
Black	B
Green	G
Red	R
Blue	S
Yellow	Y
White	W

1. In place of ①, specify the Button Color Code from table.
2. For sub-assembled part numbers, see next page.
3. For accessories, see page 693.
4. For dimensions, see page 695.
5. Keyed switches are supplied with two keys. All units are keyed alike.



Non-Illuminated Pushbuttons (Sub-Assembled)

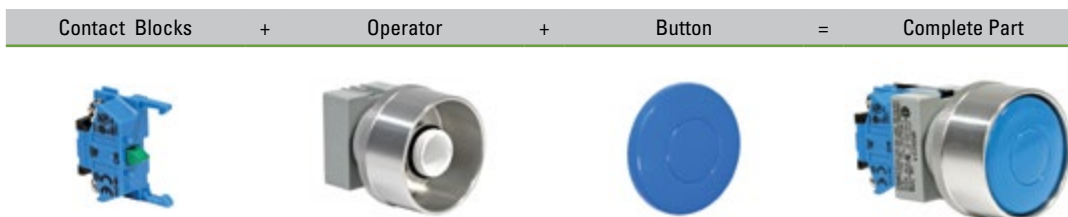

Operators

Style	Part Number	
	Momentary	Maintained
Round Flush/Extended 	ABW-100	AOW-100
Round with Full Shroud/ Recessed 	ABFW-200	AOFW-200
Ø 40mm, Ø 29mm Mushroom Head 	ABW-300	AOW-300
Ø 40mm Mushroom Head with Full Shroud 	ABGW-400	AOGW-400
Square Flush/Extended 	ABQW-100	AQW-100
Keylock Push On/Off 	—	AKW-200

Buttons

Style	Part Number
Round Flush 	ABW1B-Ⓢ
Round Extended 	ABW2B-Ⓢ
Ø 29mm Mushroom 	ABW3B-Ⓢ
Ø 40mm Mushroom 	ABW4B-Ⓢ
Square Flush 	ABQW1B-Ⓢ
Square Extended 	ABQW2B-Ⓢ



In place of Ⓢ specify the button color code from table

Contact Blocks

Style	Part Number	
	1NO	1NC
Standard Exposed Screw 	HW-C10 HW-C10R (early make)	HW-C01 HW-C01R (late break)
Fingersafe (IP20), CE marked 	HW-F10 HW-F10R (early make)	HW-F01 HW-F01R (late break)
Dummy Block 	TW-DB	



1. Dummy blocks (no contacts) are used with an odd number of contact blocks.
2. Use of early and late break contacts creates a make before break function

① Button Color Codes

Color	Code
Black	B
Green	G
Red	R
Blue	S
Yellow	Y
White	W



Stop Switches (Assembled)



Assembled Stop Switches

A V (L) W 4 (B) (99) 11 (D) (N) - R - (24V)

Function

- V: Pushlock Turn Reset
- Y: Push-Pull
- X: Pushlock Key Reset

Illumination

- Blank: None
- L: Illuminated

Series Designation

W: TW Series

Button/Lens Size

- 3: 29mm Mushroom
- 4: 40mm Mushroom

Lens Type

(illuminated units only)

- Blank: Standard (ribbed)
- B: Engravable (smooth with insert)

Illuminated Circuit

(illuminated unit only)

- 99: Full Voltage (lamp determines voltage)
- 126: 120V AC Step Down Transformer
- 246: 240V AC Step Down Transformer
- 486: 480V AC Step Down Transformer

Lamp Voltage

(full voltage illuminated units only)

- 6V: 6V AC/DC
- 12V: 12V AC/DC
- 24V: 24V AC/DC
- 120V: 120V AC (LED only)
- 240V: 240V AC (LED only)

Button/Lens Color

- A: Amber R: Red W: White
- G: Green S: Blue Y: Yellow
- B: Black

Contact Terminal Style

- Blank: Standard
- N: Fingersafe (IP20)

Lamp Type

(illuminated units only)

- Blank: Incandescent
- D: LED

Contact Arrangement





- 10: 1NO 01: 1NC
- 20: 2NO 02: 2NC
- 11: 1NO/1NC 22: 2NO/2NC



To be used for interpreting part numbers only, not for part number development.

Stop Switches (Assembled), continued

Non-Illuminated Stop Switches

	Style	Contacts	Part Number
Ø 40mm Pushlock Turn Reset*		1NO	AVW410-R*
		1NC	AVW401-R*
		1NO-1NC	AVW411-R*
		2NO	AVW420-R*
		2NC	AVW402-R*
Ø 29mm Pushlock Turn Reset*		1NO	AVW310-R*
		1NC	AVW301-R*
		1NO-1NC	AVW311-R*
		2NO	AVW320-R*
		2NC	AVW302-R*
Ø 40mm Push-Pull		1NO	AYW410-⓪
		1NC	AYW401-⓪
		1NO-1NC	AYW411-⓪
		2NO	AYW420-⓪
		2NC	AYW402-⓪
Ø 40mm Pushlock Key Reset *		1NO	AXW410- R*
		1NC	AXW401- R*
		1NO-1NC	AXW411- R*
		2NO	AXW420- R*
		2NC	AXW402- R*

① Button Color Codes

Color	Code
Black	B
Green	G
Red	R
Blue	S
White	W
Yellow	Y

② LED/Lens Color Codes

Color	Code
Amber	A
Green	G
Red	R
Blue	S
White	W

③ Full Voltage Codes

Voltage	Code
6V AC/DC	6V
12V AC/DC	12V
24V AC/DC	24V
120V AC	120V (LED only)
240V AC	240V (LED only)

④ Transformer Voltage Codes

Voltage	Code
120VAC	126
240VAC	246
480VAC	486





Transformers step down to 6V.

⑤ Lamp Type Codes

Lamp	Code
Incandescent	Blank
LED	D

- 1. \*Available in Red only.
- 2. In place of ⓪, specify the Button Color Code from table.
- 3. For sub-assembled part numbers, see next page.
- 4. For accessories, see page 693.
- 5. For dimensions, see page 695.

Illuminated Stop Switches

	Style	Type	Contacts	Part Number
Ø 40mm Pushlock Turn Reset Type		Transformer	1NO-1NC	AVLW4 ⓪ 11 ⓪ -R*
			2NO	AVLW4 ⓪ 20 ⓪ -R*
			2NC	AVLW4 ⓪ 02 ⓪ -R*
		Full Voltage	1NO-1NC	AVLW49911 ⓪ -R* - ⓐ
		2NO	AVLW49920 ⓪ -R* - ⓐ	
		2NC	AVLW49902 ⓪ -R* - ⓐ	
Ø 29mm Pushlock Turn Reset		Transformer	1NO-1NC	AVLW3 ⓪ 11 ⓪ -R*
			2NO	AVLW3 ⓪ 20 ⓪ -R*
			2NC	AVLW3 ⓪ 02 ⓪ -R*
		Full Voltage	1NO-1NC	AVLW39911 ⓪ -R* - ⓐ
		2NO	AVLW39920 ⓪ -R* - ⓐ	
		2NC	AVLW39902 ⓪ -R* - ⓐ	
Ø 40mm Push-Pull		Transformer	1NO-1NC	AYLW4 ⓪ 11 ⓪ -ⓐ
			2NO	AYLW4 ⓪ 20 ⓪ -ⓐ
			2NC	AYLW4 ⓪ 02 ⓪ -ⓐ
		Full Voltage	1NO-1NC	AYLW49911 ⓪ -ⓐ - ⓐ
		2NO	AYLW49920 ⓪ -ⓐ - ⓐ	
		2NC	AYLW49902 ⓪ -ⓐ - ⓐ	

- 1. \*Available in red only.
- 2. In place of ⓐ, specify the Lens Color Code (see table above).
- 3. In place of ⓐ, specify the Full Voltage Code (lamp voltage) (see table above).
- 4. In place of ⓐ, specify the Transformer Voltage Code (see table above).
- 5. In place of ⓐ, specify the Lamp Type Code from table above.
- 6. For sub-assembly part numbers, see next page.
- 7. For accessories, see page 693.
- 8. For dimensions, see page 695.

Stop Switches (Sub-Assembled)

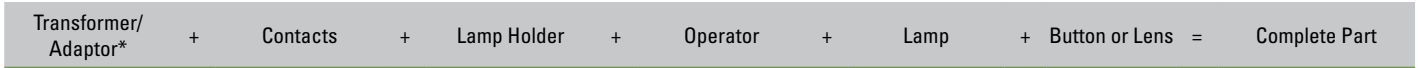





\*Not applicable for full voltage units

Operators



Style	Part Number	
	Non-Illuminated	Illuminated
Ø 29/Ø 40mm Push-lock Turn Reset 	AVW-300	AVLW3-0600
Ø 40mm Push-Pull 	AYW-400	AYLW4-0600
Ø 40mm Pushlock Key Reset 	AXW-300	—

Buttons

Style	Part Number
Ø 40mm Pushlock Turn Reset 	AVW4B-R*
Ø 29mm Pushlock Turn Reset 	AVW3B-R*
Ø 40mm Push-Pull 	AYW4B-⊙
Ø 40mm Pushlock Key Reset 	AXW4B-R*

- 1. \*Available in Red only
- 2. In place of ⊙, specify the button color code from table.

Lamps

Style	Voltage	Part Number
LED 	6V AC/DC	LSTD-6⊙
	12V AC/DC	LSTD-1⊙
	24V AC/DC	LSTD-2⊙
	120V AC	LSTD-H2⊙
	240V AC	LSTD-M4⊙
Incandescent 	6V AC/DC	IS-6
	12V AC/DC	IS-12
	24V AC/DC	IS-24

- 1. In place of ⊙, specify the LED color code.
- 2. The LED contains a current-limiting resistor and a protection diode.

① Button Color Codes

Color	Code
Black	B
Green	G
Red	R
Blue	S
White	W
Yellow	Y

② LED/Lens Color Codes

Color	Code
Amber	A
Green	G
Red	R
Blue	S
White	W



Illuminated Stop Switches (Sub-Assembled) continued

Lenses

Style	Part Number	
	Standard	Engravable
Ø 29mm Head Pushlock Turn Reset 	AVLW3LU-R*	AVLW3BLU-R*
Ø 40mm Head Pushlock Turn Reset 	AVLW4LU-R*	AVLW4BLU-R*
Ø 40mm Head Push Pull 	AYLW4LU-⊗	AYLW4BLU-⊗

- 1. In place of ⊗, specify the lens color code from table on previous page.
- 2. \*Available only in red
- 3. Standard lenses have ribbed pattern, Engravable lenses are smooth and include an engravable insert.

Lamp Circuit Components



Style	Application	Part Number
Short Lamp Holder 	<b>Used with</b> a Half-size Transformer and one contact block	TW-LH1
Long Lamp Holder 	<b>Used with</b> Full-size Transformer and two contact blocks <b>Used with</b> Half-size Transformer and three contact blocks <b>Used with</b> Full Voltage Adaptor and two contact blocks	TW-LH2
Lead Holder 	<b>Used with</b> TW-LH2 holder when using four contact blocks	HW-LH3

Transformers/Full Voltage Modules

Style	Description	Part Number	
Full Size Transformer 	Standard	120V AC	TW-T126B
		240V AC	TW-T246B
		480V AC	TW-T486B
	Fingersafe	120V AC	TW-F126B
		240V AC	TW-F246B
		480V AC	TW-F486B
Half Size Transformer 	120V AC	TW-T126SB	
	240V AC	TW-T246SB	
Full voltage model (use with even number of contacts) 	Standard	TW-DA1B	
	Fingersafe	TW-DA1FB	
Full voltage model (use with odd number of contacts) 	Standard	HW-DA1B	
	Fingersafe	HW-DA1FB	

 All Transformers step down to 6V (use 6V lamp).

Contact Blocks

Style	Part Number	
	1NO	1NC
Standard Exposed Screw 	HW-C10	HW-C01
	HW-C10R (early make)	HW-C01R (late break)
Fingersafe (IP20), CE marked 	HW-F10	HW-F01
	HW-F10R (early make)	HW-F01R (late break)
Dummy Block 	TW-DB	

- 1. Dummy blocks (no contacts) are used with an odd number of contact blocks.
- 2. Use of early and late break contacts creates a make before break function

Pilot Lights (Assembled)



Assembled Pilot Lights

**A P (Q) W 1 (B) (99) (D) - R - (24V)**

**Function**

P: Pilot Light

**Bezel Shape**

Blank: Octagonal (round lenses)  
Q: Square

**Series Designation**

W: TW Series

**Lens Shape**

1: Flat  
2: Dome

**Lens Type**

Blank: Standard (ribbed)  
B: Engravable (smooth with insert included)

**Illumination Circuit**

- 99: Full Voltage (lamp determines voltage)
- 126: 120V AC Step Down Transformer
- 246: 240V AC Step Down Transformer
- 486: 480V AC Step Down Transformer

**Lamp Voltage**

(Full Voltage Units Only)

- 6V: 6V AC/DC
- 12V: 12V AC/DC
- 24V: 24V AC/DC
- 120V: 120V AC (LED only)
- 240V: 240V AC (LED only)

**Lens Color Code**

- A: Amber
- G: Green
- R: Red
- S: Blue
- W: White
- Y: Yellow

**Lamp Type**

- Blank: Incandescent
- D: LED

1. Use only when interpreting part numbers. Do not use for developing part numbers.  
2. All transformers step down to 6V.

Pilot Lights (Assembled) continued

Assembled Pilot Lights

Style	Type	Voltage	Part Number
Round Flat	Transformer	120VAC 240VAC 480VAC	APW1126④-② APW1246④-② APW1486④-②
	Full Voltage	—	APW199④-②-③
Dome	Transformer	120VAC 240VAC 480VAC	APW2126④-② APW2246④-② APW2486④-②
	Full Voltage	—	APW299④-②-③
Square Flat	Transformer	120VAC 240VAC 480VAC	APQW1B126④-② APQW1B246④-② APQW1B486④-②
	Full Voltage	—	APQW1B99④-②-③

- 1. In place of ②, specify the Lens Color Code from table below.
- 2. In place of ③, specify the Full Voltage Code from table below.
- 3. In place of ④, specify the Lamp Type Code from table below.
- 4. For accessories, see page 693.
- 5. For dimensions, see page 695.
- 6. For sub-assembly part numbers, see next page.
- 7. Yellow pilot light comes with white LED.

② Lens Color Codes

Color	Code
Amber	A
Green	G
Red	R
Blue	S
White	W
Yellow	Y

③ Full Voltage Codes

Voltage	Code
6V AC/DC	6V
12V AC/DC	12V
24V AC/DC	24V
120V AC	120V (LED only)
240V AC	240V (LED only)

④ Lamp Type Codes

Lamp	Code
Incandescent	Blank
LED	D

Pilot Lights (Sub-Assembled)

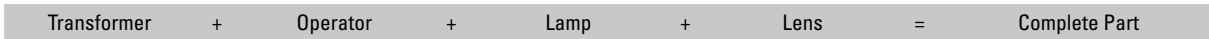

\* Transformer not required for full voltage units.



Operators

Style	Part Number
Round Dome/Flat	APW-199
	
Square	UPQW-199
	



Same operator is used for full voltage as for transformer completed units.

Lamps

Style	Voltage	Part Number
	6V AC/DC	LSTD-6Ⓢ
	12V AC/DC	LSTD-1Ⓢ
	24V AC/DC	LSTD-2Ⓢ
	120V AC	LSTD-H2Ⓢ
	240V AC	LSTD-M4Ⓢ
	6V AC/DC	IS-6
	12V AC/DC	IS-12
	24V AC/DC	IS-24

Ⓢ LED/Lens Color Codes

Color	Code
Amber	A
Green	G
Red	R
Blue	S
White	W
Yellow	Y



If clear lens is desired, use white marking lens and remove engraving insert



- In place of Ⓢ, specify the LED color code.
- The LED contains a current-limiting resistor and a protection diode.
- Yellow LED not available. Use white LED.

Transformers

Style	Description	Part Number
	Standard	120V AC TW-T126B 240V AC TW-T246B 480V AC TW-T486B
	Fingersafe	120V AC TW-F126B 240V AC TW-F246B 480V AC TW-F486B



All Transformers step down to 6V (use 6V lamp).

Lenses

Style	Part Number	
	Standard	Engravable
Dome 	APW2LU-Ⓢ	—
Round Flat 	APW1LU-Ⓢ	APW1BLU-Ⓢ
Square Flat 	—	APQW1BLU-Ⓢ



- In place of Ⓢ, specify the Lens Color Code from table.
- Standard lenses have a ribbed lens to enhance light dispersion. Marking lenses are smooth and include an engraving insert.



Illuminated Pushbuttons (Assembled)



Assembled Illuminated Pushbuttons

**A L (F) W 2 (B) 99 11 (D) (N) - R - (24V)**

**Function**

L: Momentary Action  
OL: Maintained Action

**Bezel Shape**

Blank: Octagonal (round lenses)  
F: Full Shroud (round lenses)  
Q: Square

**Series Designation**

W: TW series

**Lens Shape/Size**

2: Standard Extended (round or square)  
3: 29mm Mushroom  
4: 40mm Mushroom

**Lens Type**

Blank: Standard (ribbed)  
B: Engravable (smooth with insert)

**Illumination Circuit**

99: Full Voltage (lamp determines voltage)  
126: 120V AC Step Down Transformer  
246: 240V AC Step Down Transformer  
486: 480V AC Step Down Transformer

**Lamp Voltage**

(Full Voltage Units Only)

6V: 6V AC/DC  
12V: 12V AC/DC  
24V: 24V AC/DC  
120V: 120V AC (LED only)  
240V: 240V AC (LED only)

**Lens Code**

A: Amber  
G: Green  
R: Red  
S: Blue  
W: White  
Y: Yellow

**Contact Terminal Style**

Blank: Standard  
N: Fingersafe

**Lamp Type**

Blank: Incandescent Lamp  
D: LED Lamp

**Contact Arrangement**

10: 1NO      01: 1NC  
20: 2NO      02: 2NC  
11: 1NO-1NC    22: 2NO-2NC

1. Use only when interpreting part numbers. Do not use for developing part numbers.  
2. Transformers step down to 6V.

**Illuminated Pushbuttons (Assembled)**

**Illuminated Pushbuttons**

Style	Contacts	Part Number		
		Momentary	Maintained	
 Extended Lens	Transformer	1NO-1NC 2NO 2NC	ALW2 ④ 11⑤-② ALW2 ④ 20⑤-② ALW2 ④ 02⑤-②	AOLW2 ④ 11⑤-② AOLW2 ④ 20⑤-② AOLW2 ④ 02⑤-②
	Full Voltage	1NO-1NC 2NO 2NC	ALW29911⑤-②-③ ALW29920⑤-②-③ ALW29902⑤-②-③	AOLW29911⑤-②-③ AOLW29920⑤-②-③ AOLW29902⑤-②-③
 Extended Lens with Full Shroud	Transformer	1NO-1NC 2NO 2NC	ALFW2 ④ 11⑤-② ALFW2 ④ 20⑤-② ALFW2 ④ 02⑤-②	AOLFW2 ④ 11⑤-② AOLFW2 ④ 20⑤-② AOLFW2 ④ 02⑤-②
	Full Voltage	1NO-1NC 2NO 2NC	ALFW29911⑤-②-③ ALFW29920⑤-②-③ ALFW29902⑤-②-③	AOLFW29911⑤-②-③ AOLFW29920⑤-②-③ AOLFW29902⑤-②-③
 ø29mm Mushroom Lens	Transformer	1NO-1NC 2NO 2NC	ALW3 ④ 11⑤-② ALW3 ④ 20⑤-② ALW3 ④ 02⑤-②	AOLW3 ④ 11⑤-② AOLW3 ④ 20⑤-② AOLW3 ④ 02⑤-②
	Full Voltage	1NO-1NC 2NO 2NC	ALW39911⑤-②-③ ALW39920⑤-②-③ ALW39902⑤-②-③	AOLW39911⑤-②-③ AOLW39920⑤-②-③ AOLW39902⑤-②-③
 ø40mm Mushroom Lens	Transformer	1NO-1NC 2NO 2NC	ALW4 ④ 11⑤-② ALW4 ④ 20⑤-② ALW4 ④ 02⑤-②	AOLW4 ④ 11⑤-② AOLW4 ④ 20⑤-② AOLW4 ④ 02⑤-②
	Full Voltage	1NO-1NC 2NO 2NC	ALW49911⑤-②-③ ALW49920⑤-②-③ ALW49902⑤-②-③	AOLW49911⑤-②-③ AOLW49920⑤-②-③ AOLW49902⑤-②-③
 Square Extended	Transformer	1NO-1NC 2NO 2NC	ALQW2B ④ 11⑤-② ALQW2B ④ 20⑤-② ALQW2B ④ 02⑤-②	AOLQW2B ④ 11⑤-② AOLQW2B ④ 20⑤-② AOLQW2B ④ 02⑤-②
	Full Voltage	1NO-1NC 2NO 2NC	ALQW2B9911⑤-②-③ ALQW2B9920⑤-②-③ ALQW2B9902⑤-②-③	AOLQW2B9911⑤-②-③ AOLQW2B9920⑤-②-③ AOLQW2B9902⑤-②-③

**② LED/Lens Color Codes**

Color	Code
Amber	A
Green	G
Red	R
Blue	S
White	W
Yellow	Y

- 1. Mushroom lenses not available in yellow.
- 2. Yellow pushbutton comes with white LED.

**③ Full Voltage Codes**

Voltage	Code
6V AC/DC	6V
12V AC/DC	12V
24V AC/DC	24V
120V AC	120V (LED only)
240V AC	240V (LED only)

**④ Transformer Voltage Codes**

Voltage	Code
120VAC	126
240VAC	246
480VAC	486

- Transformers step down to 6V (use 6V lamp).

**⑤ Lamp Type Codes**

Lamp	Code
Incandescent	Blank
LED	D

- 1. In place of ②, specify the Lens Color Code (see table). Mushroom lenses not available in yellow.
- 2. In place of ③, specify the Full Voltage Code (lamp voltage) (see table).
- 3. In place of ④, specify the Transformer Voltage Code (see table).
- 4. In place of ⑤, specify the Lamp Type Code from table.
- 5. For sub-assembly part numbers, see next page.
- 6. For accessories, see page 693.
- 7. For dimensions, see page 695.
- 8. Light is independent of switch position.
- 9. Yellow pushbutton comes with white LED.

Illuminated Pushbuttons (Sub-Assembled)

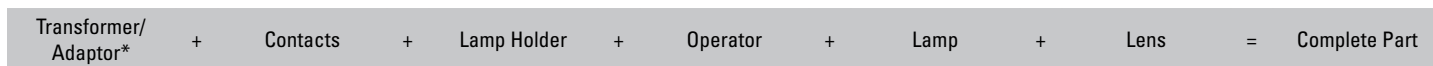

\*Not applicable for full voltage units

Operators

Style	Image	Part Number	
		Momentary	Maintained
Extended		ALW-0600	AOLW-0600
Extended with Full Shroud		ALFW-0600	AOLFW-0600
ø29mm/ø40mm Mushroom		ALW3-0600	AOLW3-0600
Square/Extended		ALQW-2B0600	AOLQW-2B0600

Lenses

Style	Image	Part Number	
		Standard	Engravable
Round Extended		ALW2LU-Ⓢ	ALW2BLU-Ⓢ
ø 29mm Mushroom Head*		ALW3LU-Ⓢ	ALW3BLU-Ⓢ
ø 40mm Mushroom Head*		ALW4LU-Ⓢ	ALW4BLU-Ⓢ
Square Extended		—	ALQW2BLU-Ⓢ

- 1. In place of Ⓢ, specify the lens color code from table on the bottom right.
- 2. \*Mushroom lens not available in yellow.
- 3. Standard lenses have ribbed pattern, Engravable lenses are smooth and include an engravable insert.

Lamps

Style	Voltage	Part Number
LED	6V AC/DC	LSTD-6Ⓢ
	12V AC/DC	LSTD-1Ⓢ
	24V AC/DC	LSTD-2Ⓢ
	120V AC	LSTD-H2Ⓢ
Incandescent	240V AC	LSTD-M4Ⓢ
	6V AC/DC	IS-6
	12V AC/DC	IS-12
	24V AC/DC	IS-24

- 1. In place of Ⓢ, specify the LED color code.
- 2. The LED contains a current-limiting resistor and a protection diode.

Lamp Circuit Components

Style	Application	Part Number
Short Lamp Holder	Used with a Half-size Transformer and one contact block	TW-LH1
Long Lamp Holder	Used with Full-size Transformer and two contact blocks Used with Half-size Transformer and three contact blocks Used with Full Voltage Adaptor and two contact blocks	TW-LH2
Lead Holder	Used with TW-LH2 holder when using four contact blocks	HW-LH3

Ⓢ LED/Lens Color Codes

Color	Code	Color	Code
Amber	A	Blue	S
Green	G	White	W
Red	R	Yellow	Y

Yellow LED not available. Use white LED.

Switches & Pilot Devices

Signaling Lights

Relays & Sockets

Timers



Contactors

Terminal Blocks

Circuit Breakers





**Illuminated Pushbuttons (Sub-Assembled) continued**

**Contact Blocks**

Style	Part Number	
	1NO	1NC
Standard Exposed Screw 	HW-C10 HW-C10R (early make)	HW-C01 HW-C01R (late break)
Fingersafe (IP20), CE marked 	HW-F10 HW-F10R (early make)	HW-F01 HW-F01R (late break)
Dummy Block 	TW-DB	

-  1. Dummy blocks (no contacts) are used with an odd number of contact blocks.
- 2. Use of early and late break contacts creates a make before break function

**Transformers/Full Voltage Modules**

Style	Description	Part Number	
Full Size Transformer 	Standard	120V AC	TW-T126B
		240V AC	TW-T246B
		480V AC	TW-T486B
	Fingersafe	120V AC	TW-F126B
		240V AC	TW-F246B
		480V AC	TW-F486B
Half Size Transformer 	120V AC	TW-T126SB	
	240V AC	TW-T246SB	
Full voltage model (use with even number of contacts) 	Standard	TW-DA1B	
	Fingersafe	TW-DA1FB	
Full voltage model (use with odd number of contacts) 	Standard	HW-DA1B	
	Fingersafe	HW-DA1FB	

 All Transformers step down to 6V (use 6V lamp).

Non-Illuminated Selector Switches (Assembled)



Assembled Selector Switches

**A S W 3 (1) (L) 20 (N) - 304**

**Function**

S: Selector Switch

**Series Designation**

W: TW Series

**Number of Positions**

- 2: 2-Position
- 3: 3-Position
- 4: 4-Position
- 5: 5-Position

**Spring Return Action**

Blank: Maintained

- 1: Spring return from Right (2 or 3 position)
- 2: Spring return from Left (2 or 3 position)
- 3: 2-Way spring return from Left and Right (3 position only)

**Circuit Number**

(Standard circuits shown on following pages and 685.)

**Contacts Terminal Style**

Blank: standard  
N: Fingersafe (IP20)

**Contact Arrangement Code**

- 10: 1NO      01: 1NC
- 20: 2NO      02: 2NC
- 40: 4NO      04: 4NC
- 11: 1NO-1NC 22: 2NO-2NC



**Operator Style Code**

Blank:      Knob Operator  
L:          Lever Operator  
K:          Key Operator

- 1. Use only when interpreting part numbers. Do not use for developing part numbers.
- 2. Custom contact configurations available.
- 3. Custom key removable codes available.
- 4. Portions of part number inside ( ) are optional.

Non-Illuminated Selector Switches (Assembled) continued

2-Position Selector Switches

Contact	Style				Part Number					
	Mounting	Operator Position			Maintained	Spring Return from Right	Spring Return from Left			
		L	R							
1NO	1	0	X	Knob Lever Key	ASW210 ASW2L10 ASW2K10	ASW2110 ASW21L10 ASW21K10	ASW2210 ASW22L10 ASW22K10			
	2	0	0							
	1	X	0					Knob Lever Key	ASW201-116 ASW2L01-116 ASW2K01-116	ASW2101-116 ASW21L01-116 ASW21K01-116
2	0	0								
1	X	0	Knob Lever Key	ASW211 ASW2L11 ASW2K11	ASW2111 ASW21L11 ASW21K11	ASW2211 ASW22L11 ASW22K11				
1NC	1	0					Knob Lever Key	ASW220 ASW2L20 ASW2K20	ASW2120 ASW21L20 ASW21K20	ASW2220 ASW22L20 ASW22K20
2	0	X								
1	X	0	Knob Lever Key	ASW202-104 ASW2L02-104 ASW2K02-104	ASW2102-104 ASW21L02-104 ASW21K02-104	ASW2202-104 ASW22L02-104 ASW22K02-104				
2NC	1	X					Knob Lever Key	ASW222 ASW2L22 ASW2K22	ASW2122 ASW21L22 ASW21K22	ASW2222 ASW22L22 ASW22K22
2	0	X								
3	0	X								
4	X	0	Knob Lever Key	ASW222-111 ASW2L22-111 ASW2K22-111	ASW2122-111 ASW21L22-111 ASW21K22-111	ASW2222-111 ASW22L22-111 ASW22K22-111				
2NO	1	0					Knob Lever Key	ASW222-111 ASW2L22-111 ASW2K22-111	ASW2122-111 ASW21L22-111 ASW21K22-111	ASW2222-111 ASW22L22-111 ASW22K22-111
2NC	2	0								
3	X	0								
4	X	0								



Switches & Pilot Devices

Signaling Lights

Relays & Sockets

Timers

Contactors

Terminal Blocks

Circuit Breakers

Non-Illuminated Selector Switches (Assembled) continued

3-Position Selector Switches

		Style			Part Number				
Contact	Mounting	Operator Position				Maintained	Spring Return from Right	Spring Return from Left	Spring Return Two-Way
		L	C	R					
2NO	1	X	0	0	Knob	ASW320	ASW3120	ASW3220	ASW3320
	2	0	0	X		ASW3L20	ASW31L20	ASW32L20	ASW33L20
2NC	1	0	X	X	Lever	ASW302	ASW3102	ASW3202	ASW3302
	2	X	X	0		ASW3L02	ASW31L02	ASW32L02	ASW33L02
2NO	1	X	0	0	Knob	ASW322	ASW3122	ASW3222	ASW3322
	2	0	0	X		ASW3L22	ASW31L22	ASW32L22	ASW33L22
2NC	3	0	X	X	Lever	ASW3K02	ASW31K02	ASW32K02	ASW33K02
	4	X	X	0		ASW3K22	ASW31K22	ASW32K22	ASW33K22
2NO	1	X	0	X	Knob	ASW322-309	ASW3122-309	ASW3222-309	ASW3322-309
	2	X	X	0		ASW3L22-309	ASW31L22-309	ASW32L22-309	ASW33L22-309
2NC	3	0	X	0	Lever	ASW3K22-309	ASW31K22-309	ASW32K22-309	ASW33K22-309
	4	0	0	X		ASW3K22-309	ASW31K22-309	ASW32K22-309	ASW33K22-309
2NO	1	0	X	0	Knob	ASW322-310	ASW3122-310	ASW3222-310	ASW3322-310
	2	0	0	X		ASW3L22-310	ASW31L22-310	ASW32L22-310	ASW33L22-310
2NC	3	0	X	0	Lever	ASW3K22-310	ASW31K22-310	ASW32K22-310	ASW33K22-310
	4	0	0	X		ASW3K22-310	ASW31K22-310	ASW32K22-310	ASW33K22-310
4NO	1	X	0	0	Knob	ASW340	ASW3140	ASW3240	ASW3340
	2	0	0	X		ASW3L40	ASW31L40	ASW32L40	ASW33L40
4NC	3	X	0	0	Lever	ASW3K40	ASW31K40	ASW32K40	ASW33K40
	4	0	0	X		ASW3K40	ASW31K40	ASW32K40	ASW33K40
4NO	1	0	X	X	Knob	ASW304	ASW3104	ASW3204	ASW3304
	2	X	X	0		ASW3L04	ASW31L04	ASW32L04	ASW33L04
4NC	3	0	X	X	Lever	ASW3K04	ASW31K04	ASW32K04	ASW33K04
	4	X	X	0		ASW3K04	ASW31K04	ASW32K04	ASW33K04



- The truth table indicates the operating position of contact block when the operator is switched to that position.  
 X = On (closed contacts)  
 0 = Off (open contacts)  
 X—X = Overlapping Contacts: Remain on (closed contacts) when switch is moved between these two positions.
- All knob and lever selector switches come in black. Other colors are available by ordering the knob or lever separately.
- Every key selector switch uses an identical key. The key is removable in any maintained position.
- Custom contact configurations are available, see page 685.

4-Position Selector Switch

		Style				Maintained	
Contact	Mounting	Operator Position					Part Number
		1	2	3	4		
2NO	1	X	0	0	0	Knob	ASW422-411
	2	0	X	0	0		ASW4L22-411
2NC	3	0	0	X	0	Lever	ASW4L22-411
	4	0	0	0	X		ASW4L22-411

5-Position Selector Switch

		Style					Maintained	
Contact	Mounting	Operator Position						Part Number
		1	2	3	4	5		
2NO	1	X	0	0	0	0	Knob	ASW522-501
	2	0	X	0	0	0		ASW5L22-501
2NC	3	0	0	0	X	0	Lever	ASW5L22-501
	4	0	0	0	0	X		ASW5L22-501





**Non-Illuminated Selector Switches (Sub-Assembled)**



- \*Not needed with key type switches.
- \*Knob type shown.



**Operators**

Style	Positions	Description	Part Number	
 <p>Knob/Lever</p>	2	Maintained	ASW200	
		Spring return from right	ASW2100	
		Spring return from left	ASW2200	
	3	Maintained, Cam 1 Maintained, Cam 2 Maintained, Cam 3		ASW300-1 ASW300-2 ASW300-3
			Spring return from right, Cam 1	ASW3100-1
			Spring return from right, Cam 2	ASW3100-2
Spring return from left, Cam 1 Spring return from left, Cam 2			ASW3200-1 ASW3200-2	
		Spring return from left/right, Cam 1	ASW3300-1	
		Spring return from left/right, Cam 2	ASW3300-2	
4	Maintained, Standard Cam	ASW400		
	Maintained, Cam 1	ASW400-1		
5	Maintained, Standard cam	ASW500		
	Maintained, Cam 1	ASW500-1		
 <p>Key</p>	2	Maintained	ASW2K00	
		Spring return from right	ASW21K00	
		Spring return from left	ASW22K00	
	3	Maintained, Cam 1 Maintained, Cam 2 Maintained, Cam 3		ASW3K00-1 ASW3K00-2 ASW3K00-3
			Spring return from right, Cam 1	ASW31K00-1
			Spring return from right, Cam 2	ASW31K00-2
		Spring return from left, Cam 1 Spring return from left, Cam 2		ASW32K00-1 ASW32K00-2
			Spring return from left/right, Cam 1	ASW33K00-1
			Spring return from left/right, Cam 2	ASW33K00-2

**Handles and Inserts**

Style	Part Number
 <p>Knob</p>	ASWHHY-①
 <p>Lever</p>	ASWHHL-①
 <p>Color Insert</p>	TW-HC1-①

**Contact Blocks**

Style	Part Number	
	1NO	1NC
 <p>Standard Exposed Screw</p>	HW-C10	HW-C01
 <p>Fingersafe (IP20), CE marked</p>	HW-C10R (early make)	HW-C01R (late break)
	HW-F10	HW-F01
 <p>Dummy Block</p>	HW-F10R (early make)	HW-F01R (late break)
	TW-DB	



- Push rod color code:  
Green = NO contact block  
Red = NC contact block.
- Dummy blocks (no contacts) are used with an odd number of contact blocks.

- Two keys are supplied with every key switch, all are keyed alike, and removable from any maintained position.
- Locking rings are included with all operators. Order knobs, levers, and color inserts separately.
- Different cams produce different contact actions. For details, see page 685.
- Key switch operator supplied with black sleeve.

**① Handle/Insert Color Codes**

Color	Code
Black*	B
Blue	S
Green	G
Red	R
Yellow	Y
White†	W

- \*Color inserts not available in black.
- †Knob and lever not available in white.

**Replacement Parts**

Key Switch Black Sleeve	AKW2B-B
-------------------------	---------

Illuminated Selector Switches (Assembled)



Assembled Illuminated Selector Switches

**A SL W 2 (2) 99 11 (D) (N) - (103) - R - (24V)**

**Function**

SL: Illuminated Selector Switch

**Series Designation**

W: TW series

**Number of Positions**

2: 2-Position  
3: 3-Position

**Spring Return Action**

Blank: Maintained  
1: Spring return from Right  
2: Spring return from Left  
3: Two-Way spring return from Left and Right

**Illumination Circuit**

99: Full Voltage (lamp determines voltage)  
126: 120V AC Step Down Transformer  
246: 240V AC Step Down Transformer  
486: 480V AC Step Down Transformer

**Lamp Voltage**

(Full Voltage Units Only)

6V: 6V AC/DC  
12V: 12V AC/DC  
24V: 24V AC/DC  
120V: 120V AC (LED only)  
240V: 240V AC (LED only)

**Lens Color Code**

A: Amber  
G: Green  
R: Red  
S: Blue  
W: White  
Y: Yellow

**Contact Circuit Number**

Standard circuits are listed on the following pages and 685.

**Contact Terminal Style**

Blank: Standard  
N: Fingersafe

**Lamp Type**

Blank: Incandescent Lamp  
D: LED Lamp

**Contact Arrangement**

10: 1NO	01: 1NC
20: 2NO	02: 2NC
40: 4NO	04: 4NC
11: 1NO-1NC	22: 2NO-2NC

1. Use only when interpreting part numbers. Do not use for developing part numbers.  
2. All transformers step down to 6V (use 6V lamp).

Illuminated Selector Switches(Assembled) continued

Illuminated 2-Position Selector Switches

Style				Lamp Circuit Type	Part Number		
Contact	Mounting	Operator Position			Maintained	Spring Return from Right	Spring Return from Left
		L	R				
1NO 1NC	1 2	0 X	X 0	Transformer Full Voltage	ASLW2 ① 11④-② ASLW29911④-②-③	ASLW21 ① 11④-② ASLW219911④-②-③	ASLW22 ① 11④-② ASLW229911④-②-③
2NO	1 2	0 0	X X	Transformer Full Voltage	ASLW2 ① 20④-② ASLW29920④-②-③	ASLW21 ① 20④-② ASLW219920④-②-③	ASLW22 ① 20④-② ASLW229920④-②-③
2NC	1 2	X X	0 0	Transformer Full Voltage	ASLW2 ① 02④-104-② ASLW29902④-104-②-③	ASLW21 ① 02④-104-② ASLW219902④-104-②-③	ASLW22 ① 02④-104-② ASLW229902④-104-②-③
2NO 2NC	1 2 3 4	0 X 0 X	X 0 X 0	Transformer Full Voltage	ASLW2 ① 22④-② ASLW29922④-②-③	ASLW21 ① 22④-② ASLW219922④-②-③	ASLW22 ① 22④-② ASLW229922④-②-③

① Transformer Voltage Codes

Voltage	Code
120VAC	126
240VAC	246
480VAC	486

Transformers step down to 6V (use 6V lamp).

② LED/Lens Color Codes

Color	Code
Amber	A
Green	G
Red	R
Blue	S
White	W
Yellow	Y

Illuminated 3-Position Selector Switches, Maintained and Spring Return from Right

Style					Lamp Circuit Type	Part Number			
Contact	Mounting	Operator Position				Maintained	Spring Return From Right	Spring Return from Left	Spring Return Two-Way
		L	C	R					
2NO	1 2	X 0	0 0	0 X	Transformer Full Voltage	ASLW3 ① 20④-② ASLW39920④-②-③	ASLW31 ① 20④-② ASLW319920④-②-③	ASLW32 ① 20④-② ASLW329920④-②-③	ASLW33 ① 20④-② ASLW339920④-②-③
2NC	1 2	0 X	X X	X 0	Transformer Full Voltage	ASLW3 ① 02④-② ASLW39902④-②-③	ASLW31 ① 02④-② ASLW319902④-②-③	ASLW32 ① 02④-② ASLW329902④-②-③	ASLW33 ① 02④-② ASLW339902④-②-③
2NO 2NC	1 2 3 4	X 0 0 X	0 0 X X	0 X X 0	Transformer Full Voltage	ASLW3 ① 22④-② ASLW39922④-②-③	ASLW31 ① 22④-② ASLW319922④-②-③	ASLW32 ① 22④-② ASLW329922④-②-③	ASLW33 ① 22④-② ASLW339922④-②-③
2NO 2NC	1 2 3 4	X X 0 0	0 X X 0	X 0 0 X	Transformer Full Voltage	ASLW3 ① 22④-309-② ASLW39922④-309-②-③	ASLW31 ① 22④-309-② ASLW319922④-309-②-③	ASLW32 ① 22④-309-② ASLW329922④-309-②-③	ASLW33 ① 22④-309-② ASLW339922④-309-②-③
2NO 2NC	1 2 3 4	0 0 0 0	X 0 X 0	0 X 0 X	Transformer Full Voltage	ASLW3 ① 22④-310-② ASLW39922④-310-②-③	ASLW31 ① 22④-310-② ASLW319922④-310-②-③	ASLW32 ① 22④-310-② ASLW329922④-310-②-③	ASLW33 ① 22④-310-② ASLW339922④-310-②-③
4NO	1 2 3 4	X 0 X 0	0 0 0 0	0 X 0 X	Transformer Full Voltage	ASLW3 ① 40④-② ASLW39940④-②-③	ASLW31 ① 40④-② ASLW319940④-②-③	ASLW32 ① 40④-② ASLW329940④-②-③	ASLW33 ① 40④-② ASLW339940④-②-③
4NC	1 2 3 4	0 X 0 X	X X X X	X 0 X 0	Transformer Full Voltage	ASLW3 ① 04④-② ASLW39904④-②-③	ASLW31 ① 04④-② ASLW319904④-②-③	ASLW32 ① 04④-② ASLW329904④-②-③	ASLW33 ① 04④-② ASLW339904④-②-③

- In place of ①, specify the Transformer Voltage Code.
- In place of ②, specify the Lens/LED Color Code.
- In place of ③, specify the Full Voltage Code.
- In place of ④ specify Lamp Type Code
- For custom contact configurations, see page 685.
- Light is independent of switch position.
- Yellow selector switch comes with white LED.

③ Full Voltage Codes

Voltage	Code
6V AC/DC	6V
12V AC/DC	12V
24V AC/DC	24V
120V AC	120V (LED only)
240V AC	240V (LED only)

④ Lamp Type Codes

Lamp	Code
Incandescent	Blank
LED	D

Switches & Pilot Devices

Signaling Lights

Relays & Sockets

Timers

Contactors

Terminal Blocks

Circuit Breakers

Illuminated Selector Switches (Sub-Assembled)

Transformer\* + Contact Block + Operator + Lamp/Lead Holder<sup>†</sup> + Lamp + Lens = Complete Part



- \*Full voltage units use a full voltage adaptor (TW-DA1B) instead of a transformer.
- †Lamp holder is not included with operators, order separately.
- Lead holder is used when using 3 or more contact blocks. Order separately.

Operators

Style	Positions	Description	Part Number
	2	Maintained	ASLW200
		Spring return from right	ASLW2100
		Spring return from left	ASLW2200
	3	Maintained, cam 1	ASLW300-1
		Maintained, cam 2	ASLW300-2
		Maintained, cam 3	ASLW300-3
	Spring return from right, cam 1	ASLW3100-1	
	Spring return from right, cam 2	ASLW3100-2	
	Spring return from left, cam 1	ASLW3200-1	
	Spring return from left, cam 2	ASLW3200-2	
	Spring return from left/right, cam 1	ASLW3300-1	
Spring return from left/right, cam 2	ASLW3300-2		

Different cams produce different contact action. For details, see Contact Arrangements on page 685.

Lenses (Knobs)

Style	Part Number
Knob	ASLWLU-②

In place of ②, specify the lens color code from table.

Lamps

Style	Voltage	Part Number
	6V AC/DC	LSTD-6②
	12V AC/DC	LSTD-1②
	24V AC/DC	LSTD-2②
	120V AC	LSTD-H2②
	240V AC	LSTD-M4②
	6V AC/DC	IS-6
	12V AC/DC	IS-12
	24V AC/DC	IS-24

- 1. In place of ②, specify the LED color code.
- 2. The LED contains a current-limiting resistor and a protection diode.



② LED/Lens Color Codes

Color	Code
Amber	A
Green	G
Red	R
Blue	S
White	W
Yellow	Y

Yellow LED not available. Use white LED



**Illuminated Selector Switches (Sub-Assembled) continued**

**Contact Blocks**





Style	Part Number	
	1NO	1NC
Standard Exposed Screw 	HW-C10 HW-C10R (early make)	HW-C01 HW-C01R (late break)
Fingersafe (IP20), CE marked 	HW-F10 HW-F10R (early make)	HW-F01 HW-F01R (late break)
Dummy Block 	TW-DB	

- 1. Dummy blocks (no contacts) are used with an odd number of contact blocks.
- 2. Use of early and late break contacts creates a make before break function

**Lamp Circuit Components**

Style	Application	Part Number
Short Lamp Holder 	<b>Used with</b> a Half-size Transformer and one contact block	TW-LH1
Long Lamp Holder 	<b>Used with</b> Full-size Transformer and two contact blocks <b>Used with</b> Half-size Transformer and three contact blocks <b>Used with</b> Full Voltage Adaptor and two contact blocks	TW-LH2
Lead Holder 	<b>Used with</b> TW-LH2 holder when using four contact blocks	HW-LH3

**Transformers/Full Voltage Modules**

Style	Description	Part Number	
Full Size Transformer 	Standard	120V AC	TW-T126B
		240V AC	TW-T246B
		480V AC	TW-T486B
	Fingersafe	120V AC	TW-F126B
		240V AC	TW-F246B
		480V AC	TW-F486B
Half Size Transformer 	120V AC	TW-T126SB	
	240V AC	TW-T246SB	
Full voltage model (use with even number of contacts) 	Standard	TW-DA1B	
	Fingersafe	TW-DA1FB	
Full voltage model (use with odd number of contacts) 	Standard	HW-DA1B	
	Fingersafe	HW-DA1FB	

 All Transformers step down to 6V (use 6V lamp).

Switches & Pilot Devices

Signaling Lights

Relays & Sockets

Timers

Contactors

Terminal Blocks

Circuit Breakers

Contact Arrangement Charts

How to Read Contact Arrangement Charts

To determine contact block mounting position, first make sure the selector switch is oriented as shown on the right

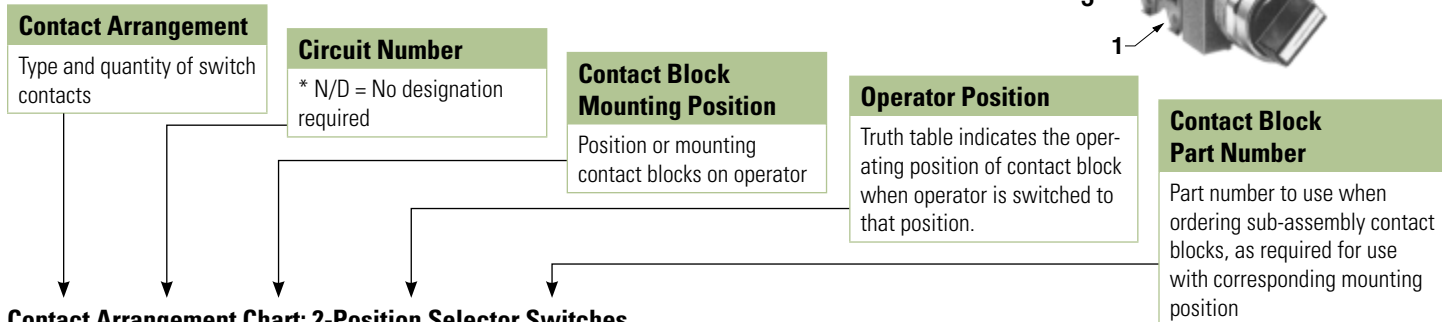
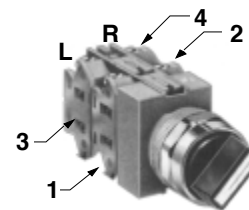

Contact Arrangement Chart: 2-Position Selector Switches

Style		Mounting Position	Operator Position		Contact Block Part Number	Description	Operator Part Number		
Contact	Circuit Number		L	R			Maintained	Spring Ret. from Rt.	Spring Ret. from Lt.
1NO	N/D	1	0	X	HW-C10	Knob/Lever Key	ASW200 ASW2K00 ASLW200	ASW2100 ASW21K00 ASLW2100	ASW2200 ASW22K00 ASLW2200
		2	0	0	TW-DB	Illuminated Knob			
1NC	116	1	X	0	HW-C01	Knob/Lever Key	ASW200 ASW2K00 ASLW200	ASW2100 ASW21K00 ASLW2100	ASW2200 ASW22K00 ASLW2200
		2	0	0	TW-DB	Illuminated Knob			
1NO 1NC	N/D	1	0	X	HW-C10	Knob/Lever Key	ASW200 ASW2K00 ASLW200	ASW2100 ASW21K00 ASLW2100	ASW2200 ASW22K00 ASLW2200
		2	X	0	HW-C01	Illuminated Knob			
	103	1	X	0	HW-C01	Knob/Lever Key	ASW200 ASW2K00 ASLW200	ASW2100 ASW21K00 ASLW2100	ASW2200 ASW22K00 ASLW2200
		2	0	X	HW-C10	Illuminated Knob			
1NO-EM 1NC-LB	600	1	0	X	HW-C10R	Knob/Lever Key	ASW200 ASW2K00 ASLW200	ASW2100 ASW21K00 ASLW2100	ASW2200 ASW22K00 ASLW2200
		2	X	0	HW-C01R	Illuminated Knob			
	601	1	X	0	HW-C01R	Knob/Lever Key	ASW200 ASW2K00 ASLW200	ASW2100 ASW21K00 ASLW2100	ASW2200 ASW22K00 ASLW2200
		2	0	X	HW-C10R	Illuminated Knob			
2NO	N/D	1	0	X	HW-C10	Knob/Lever Key	ASW200 ASW2K00 ASLW200	ASW2100 ASW21K00 ASLW2100	ASW2200 ASW22K00 ASLW2200
		2	0	X	HW-C10	Illuminated Knob			
2NC	104	1	X	0	HW-C01	Knob/Lever Key	ASW200 ASW2K00 ASLW200	ASW2100 ASW21K00 ASLW2100	ASW2200 ASW22K00 ASLW2200
		2	X	0	HW-C01	Illuminated Knob			
2NO 2NC	N/D	1	0	X	HW-C10	Knob/Lever Key Illuminated Knob	ASW200 ASW2K00 ASLW200	ASW2100 ASW21K00 ASLW2100	ASW2200 ASW22K00 ASLW2200
		2	X	0	HW-C01				
		3	0	X	HW-C10				
		4	X	0	HW-C01				
	111	1	0	X	HW-C10	Knob/Lever Key Illuminated Knob	ASW200 ASW2K00 ASLW200	ASW2100 ASW21K00 ASLW2100	ASW2200 ASW22K00 ASLW2200
		2	0	X	HW-C10				
		3	X	0	HW-C01				
		4	X	0	HW-C01				

1. NO-EM, NC-LB = Early Make, Late Break.  
N/D = No circuit number designation required in assembled selector switch part number.  
2. X = On (closed contacts) 0 = Off (Open contacts)

Switches & Pilot Devices

Signaling Lights

Relays & Sockets

Timers

Contactors

Terminal Blocks

Circuit Breakers



Contact Arrangement Chart: 3-Position Selector Switches

Contact	Circuit Number	Mounting Position	Operator Position			Contact Block Part Number	Description	Operator Part Number				
			L	C	R			Maintained	Spring Return from Right	Spring Return from Left	Two-Way	
1NO 1NC	202	1	X	0	0	HW-C10	Knob/Lever Key	ASW300-1 ASW3K00-1 ASLW300-1	ASW3100-1 ASW31K00-1 ASLW3100-1	ASW3200-1 ASW32K00-1 ASLW3200-1	ASW3300-1 ASW33K00-1 ASLW3300-1	
		2	X	X	0	HW-C01	Illuminated Knob					
	203	1	0	X	X	HW-C01	Knob/Lever Key	ASW300-1 ASW3K00-1 ASLW300-1	ASW3100-1 ASW31K00-1 ASLW3100-1	ASW3200-1 ASW32K00-1 ASLW3200-1	ASW3300-1 ASW33K00-1 ASLW3300-1	
		2	0	0	X	HW-C10	Illuminated Knob					
	302	1	X	0	X	HW-C10	Knob/Lever Key	ASW300-2 ASW3K00-2 ASLW300-2	ASW3100-2 ASW31K00-2 ASLW3100-2	ASW3200-2 ASW32K00-2 ASLW3200-2	ASW3300-2 ASW33K00-2 ASLW3300-2	
		2	X	X	0	HW-C01	Illuminated Knob					
	303	1	0	X	0	HW-C01	Knob/Lever Key	ASW300-2 ASW3K00-2 ASLW300-2	ASW3100-2 ASW31K00-2 ASLW3100-2	ASW3200-2 ASW32K00-2 ASLW3200-2	ASW3300-2 ASW33K00-2 ASLW3300-2	
		2	0	0	X	HW-C10	Illuminated Knob					
	2NO	N/D	1	X	0	0	HW-C10	Knob/Lever Key	ASW300-1 ASW3K00-1 ASLW300-1	ASW3100-1 ASW31K00-1 ASLW3100-1	ASW3200-1 ASW32K00-1 ASLW3200-1	ASW3300-1 ASW33K00-1 ASLW3300-1
			2	0	0	X	HW-C10	Illuminated Knob				
301		1	X	0	X	HW-C10	Knob/Lever Key	ASW300-2 ASW3K00-2 ASLW300-2	ASW3100-2 ASW31K00-2 ASLW3100-2	ASW3200-2 ASW32K00-2 ASLW3200-2	ASW3300-2 ASW33K00-2 ASLW3300-2	
		2	0	0	X	HW-C10	Illuminated Knob					
2NC	304	1	0	X	0	HW-C01	Knob/Lever Key	ASW300-2 ASW3K00-2 ASLW300-2	ASW3100-2 ASW31K00-2 ASLW3100-2	ASW3200-2 ASW32K00-2 ASLW3200-2	ASW3300-2 ASW33K00-2 ASLW3300-2	
		2	X	X	0	HW-C01	Illuminated Knob					
	N/D	1	0	X	X	HW-C01	Knob/Lever Key	ASW300-1 ASW3K00-1 ASLW300-1	ASW3100-1 ASW31K00-1 ASLW3100-1	ASW3200-1 ASW32K00-1 ASLW3200-1	ASW3300-1 ASW33K00-1 ASLW3300-1	
		2	X	X	0	HW-C01	Illuminated Knob					
2NO 2NC	N/D	1	X	0	0	HW-C10	Knob/Lever Key Illuminated Knob	ASW300-1 ASW3K00-1 ASLW300-1	ASW3100-1 ASW31K00-1 ASLW3100-1	ASW3200-1 ASW32K00-1 ASLW3200-1	ASW3300-1 ASW33K00-1 ASLW3300-1	
		2	0	0	X	HW-C10						
		3	0	X	X	HW-C01						
		4	X	X	0	HW-C01						
	210	1	0	X	X	HW-C01	Knob/Lever Key Illuminated Knob	ASW300-1 ASW3K00-1 ASLW300-1	ASW3100-1 ASW31K00-1 ASLW3100-1	ASW3200-1 ASW32K00-1 ASLW3200-1	ASW3300-1 ASW33K00-1 ASLW3300-1	
		2	0	0	X	HW-C10						
		3	0	X	X	HW-C01						
		4	0	0	X	HW-C10						
	308	1	X	0	X	HW-C10	Knob/Lever Key Illuminated Knob	ASW300-2 ASW3K00-2 ASLW300-2	ASW3100-2 ASW31K00-2 ASLW3100-2	ASW3200-2 ASW32K00-2 ASLW3200-2	ASW3300-2 ASW33K00-2 ASLW3300-2	
		2	X	X	0	HW-C01						
		3	X	0	X	HW-C10						
		4	X	X	0	HW-C01						
309	1	X	0	X	HW-C10	Knob/Lever Key Illuminated Knob	ASW300-2 ASW3K00-2 ASLW300-2	ASW3100-2 ASW31K00-2 ASLW3100-2	ASW3200-2 ASW32K00-2 ASLW3200-2	ASW3300-2 ASW33K00-2 ASLW3300-2		
	2	X	X	0	HW-C01							
	3	0	X	0	HW-C01							
	4	0	0	X	HW-C10							
310	1	0	X	0	HW-C01	Knob/Lever Key Illuminated Knob	ASW300-2 ASW3K00-2 ASLW300-2	ASW3100-2 ASW31K00-2 ASLW3100-2	ASW3200-2 ASW32K00-2 ASLW3200-2	ASW3300-2 ASW33K00-2 ASLW3300-2		
	2	0	0	X	HW-C10							
	3	0	X	0	HW-C01							
	4	0	0	X	HW-C10							

1. Each operator sub-assembly is available as a "-1" and a "-2" for 3-position selector switches. The internal cam of a "-1" is different from that of a "-2". This results in designated combinations of open and closed contacts in the various operator positions.
2. N/D = No circuit number designation required in assembled part number.
3. X = On (closed contacts) 0 = Off (open contacts). X X Overlapping contacts remain on (closed) when switch is moved between these two positions.



Contact Arrangement Chart: 3-Position Selector Switches

Style		Mounting Position	Operator Position			Contact Block Part Number	Description	Operator Part Number			
Contact	Circuit Number		L	C	R			Maintained	Spring Return from Right	Spring Return from Left	Two-Way
4NO	N/D	1	X	0	0	HW-C10	Knob/Lever Key Illuminated Knob	ASW300-1 ASW3K00-1 ASLW300-1	ASW3100-1 ASW31K00-1 ASLW3100-1	ASW3200-1 ASW32K00-1 ASLW3200-1	ASW3300-1 ASW33K00-1 ASLW3300-1
		2	0	0	X	HW-C10					
		3	X	0	0	HW-C10					
		4	0	0	X	HW-C10					
	305	1	X	0	X	HW-C10	Knob/Lever Key Illuminated Knob	ASW300-2 ASW3K00-2 ASLW300-2	ASW3100-2 ASW31K00-2 ASLW3100-2	ASW3200-2 ASW32K00-2 ASLW3200-2	ASW3300-2 ASW33K00-2 ASLW3300-2
		2	0	0	X	HW-C10					
		3	X	0	X	HW-C10					
		4	0	0	X	HW-C10					
4NC	N/D	1	0	X	X	HW-C01	Knob/Lever Key Illuminated Knob	ASW300-1 ASW3K00-1 ASLW300-1	ASW3100-1 ASW31K00-1 ASLW3100-1	ASW3200-1 ASW32K00-1 ASLW3200-1	ASW3300-1 ASW33K00-1 ASLW3300-1
		2	X	X	0	HW-C01					
		3	0	X	X	HW-C01					
		4	X	X	0	HW-C01					
	314	1	0	X	0	HW-C01	Knob/Lever Key Illuminated Knob	ASW300-2 ASW3K00-2 ASLW300-2	ASW3100-2 ASW31K00-2 ASLW3100-2	ASW3200-2 ASW32K00-2 ASLW3200-2	ASW3300-2 ASW33K00-2 ASLW3300-2
		2	X	X	0	HW-C01					
		3	0	X	0	HW-C01					
		4	X	X	0	HW-C01					

- 1. Each operator sub-assembly is available as a "-1" and a "-2" for 3-position selector switches. The internal cam of a "-1" is different from that of a "-2". This results in designated combinations of open and closed contacts in the various operator positions.
- 2. N/D = No circuit number designation required in assembled part number.
- 3. X = On (closed contacts) 0 = Off (open contacts). X X Overlapping contacts remain on (closed) when switch is moved between these two positions.

Switches & Pilot Devices

Signaling Lights

Relays & Sockets

Timers

Contactors

Terminal Blocks

Circuit Breakers

### Custom Selector Switch Building Guide

To build a custom selector switch, follow these steps.

#### Step 1

How many positions of the switch are needed?

# of positions  
(2, 3, 4, 5)

#### Step 2

How many contacts should there be?

# of isolated contacts  
(maximum 6)

#### Step 3

Fill in the Truth Table

(X = closed, 0 = open)

		Knob Position				
		1	2	3	4	5
Contacts	1					
	2					
	3					
	4					
	5					
	6					

#### Step 4

If building a 2 position selector, skip this step. (2 position selectors have only one cam)

If building a 3, 4, or 5 position selector, determine appropriate cam as follows:

- Look at Row 1 from above table and locate an identical row in the operator truth tables (See next page).
- Repeat for all rows. The user must find one operator that contains all rows from above table.
- Record the operator cam version.

#### Step 5

Build by placing appropriate contact in appropriate mounting position for each desired row on operator cam truth table. "L" and "R" refer to mounting on left or right side of operator as viewed from the front of the panel.

#### Step 6

Develop an assembly part number (if necessary) as follows: follow standard numbering nomenclature for selector switches (see pages 677 or 681. In place of the "Circuit Number" indicate the cam number and contact arrangement as such ASW322-3-OELCXX, where "3" is the cam number, and contact arrangement "OELCXX" calls out individual contact mounting locations in order (see diagram above). O=NO, C=NC, E=NO-EM, L=NC-LB, X= no contact. Part number must designate all 6 possible mounting locations.

Mounting Positions

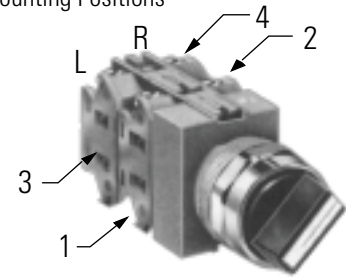

Caution: Before putting any custom selector switch into use, the user should use an ohmmeter to test for desired performance.

1. For Operator Truth Tables, see next page.

Operator Truth Tables

Use the following tables to build custom selector switches.

2 Position Selector Switches

	Contact	Mounting Position	Operator Position	
			Left	Right
			ASW200 ASLW200 ASW2K00	HW-C10 (NO)
R	0	X		
HW-C01 (NC)	L	X		0
	R	X		0
HW-C10R (NO-EM)	L	0		X
	R	0		X
HW-C01R (NC-LB)	L	X	0	
	R	X	0	

3 Position Selector Switches

	Contact	Mounting Position	Operator Position		
			Left	Center	Right
			ASW300-1 ASW3K00-1 ASLW300-1	HW-C10 (NO)	L
R	0	0			X
HW-C01 (NC)	L	0		X	X
	R	X		X	0
HW-C10R (NO-EM)	L	X		0	0
	R	0		0	X
HW-C01R (NC-LB)	L	0	X	X	
	R	X	X	0	

	Contact	Mounting Position	Operator Position		
			Left	Center	Right
			ASW300-2 ASW3K00-2 ASLW300-2	HW-C10 (NO)	L
R	0	0			X
HW-C01 (NC)	L	0		X	0
	R	X		X	0
HW-C10R (NO-EM)	L	X		0	X
	R	0		0	X
HW-C01R (NC-LB)	L	0	X	0	
	R	X	X	0	

	Contact	Mounting Position	Operator Position		
			Left	Center	Right
			ASW300-3 ASW3K00-3 ASLW300-3	HW-C10 (NO)	L
R	0	0			X
HW-C01 (NC)	L	0		X	0
	R	0		X	0
HW-C10R (NO-EM)	L	X		0	X
	R	X		0	X
HW-C01R (NC-LB)	L	0	X	X	
	R	X	X	0	

4 Position Selector Switches

	Contact	Mounting Position	Operator Position			
			1	2	3	4
			ASW400	HW-C10 (NO)	L	X
R	0	X			0	0
HW-C01 (NC)	L	0		X	X	X
	R	X		0	X	X
HW-C10R (NO-EM)	L	X		0	0	0
	R	0		X	0	0
HW-C01R (NC-LB)	L	0	X	X	X	
	R	X	0	X	X	

	Contact	Mounting Position	Operator Position			
			1	2	3	4
			ASW400-1	HW-C10 (NO)	L	X
R	0	0			0	X
HW-C01 (NC)	L	0		0	X	0
	R	0		X	0	0
HW-C10R (NO-EM)	L	X		X	0	X
	R	X		0	X	X
HW-C01R (NC-LB)	L	0	X	X	X	
	R	X	X	X	0	

5 Position Selector Switches

	Contact	Mounting Position	Operator Position				
			1	2	3	4	5
			ASW500	HW-C10 (NO)	L	X	0
R	0	X			0	0	0
HW-C01 (NC)	L	0		0	X	X	X
	R	0		0	0	X	X
HW-C10R (NO-EM)	L	X		0	0	0	0
	R	0		X	0	0	0
HW-C01R (NC-LB)	L	0	X	X	X	X	
	R	X	0	X	X	X	

	Contact	Mounting Position	Operator Position				
			1	2	3	4	5
			ASW500-1	HW-C10 (NO)	L	X	0
R	0	0			0	0	X
HW-C01 (NC)	L	0		0	0	X	0
	R	0		X	0	0	0
HW-C10R (NO-EM)	L	X		X	X	0	X
	R	X		0	X	X	X
HW-C01R (NC-LB)	L	0	X	X	X	X	
	R	X	X	X	X	0	

Switches & Pilot Devices

Signaling Lights

Relays & Sockets

Timers

Contactors

Terminal Blocks

Circuit Breakers

Nameplates – TW Series

Faceplates

	NWAL	NWAQL	NWAS	EMERGENCY STOP
	<b>Part Number</b>			
<b>Nameplate (blank)</b>	NWAL-OB (black) NWAL-OR (red)	NWAQL-OB (black) NWAQL-OR (red)	NWAS-OB	NWAR-0
<b>Nameplate (engraved)</b>	NWAL-Ⓢ	NWAQL-Ⓢ	NWAS-Ⓢ	NWAR-27†

1. In place of Ⓢ, insert either the Standard Legend Code from table below or custom engraving delimited by “ ”.
2. Standard engravings are available at no charge.
3. NWAR-27 comes marked “Emergency Stop” as shown in drawing.

Standard Legend Codes

Pushbuttons				Pushbuttons/Selector Switches				Selector Switches	
Legend	Code	Legend	Code	Legend	Code	Legend	Code	Legend	Code
AUTO	101	OPEN	116	AUTO-MAN	201			AUTO-MAN-OFF	301
CLOSE	102	OUT	117	CLOSE-OPEN	202			AUTO-OFF-MAN	302
DOWN	103	RAISE	118	DOWN-UP	203			CLOSE-OFF-OPEN	303
EMERG.STOP	104	RESET	119	FAST-SLOW	204			DOWN-OFF-SLOW	304
FAST	105	REVERSE	120	FOR-REV	205	REV-FOR	216	FAST-OFF-SLOW	305
FORWARD	106	RUN	121	HAND-AUTO	206	RUN-JOG	217	FOR-OFF-REV	306
HAND	107	SLOW	122	HIGH-LOW	207	RUN-SAFE	218	LEFT-OFF-RIGHT	307
HIGH	108	START	123	JOG-RUN	208	SAFE-RUN	219	LOWER-OFF-RAISE	308
IN	109	STOP	124	LEFT-RIGHT	209	SLOW-FAST	220	OFF-MAN-AUTO	309
INCH	110	STOP	125	LOWER-RAISE	210	START-STOP	221	OFF-SLOW-FAST	310
JOG	111	TEST	126	MAN-AUTO	211	STOP-START	222	OFF-1-2	311
LOW	112	UP	127	OFF-ON	212	UP-DOWN	223	OPEN-OFF-CLOSE	312
LOWER	113	I (Int'l On)	150	ON-OFF	213			SLOW-OFF-FAST	313
OFF	114	O (Int'l Off)	151	OPEN-CLOSE	214			SUMMER-OFF-WINTER	314
ON	115	EMO	152	RAISE-LOWER	215			UP-OFF-DOWN	315
								1-OFF-2	316
								HAND-OFF-AUTO	317

1. To order engraved nameplates, add legend code to nameplate part number. Character height based on the number of characters and size of nameplate. Standard character size is 3/16”.
2. Nameplates with standard legends are the same list price as blank nameplates.

Nameplate Order Form on next page.

**Custom Engraved Nameplates Order Form – TW Series**

Copy this order form and use it to specify Letter Height, Custom Engravings, Location of Engraving on Nameplate, and Quantity Desired. To ensure engraving accuracy, fax it to your IDEC representative, or Distributor.

Your Company Name: \_\_\_\_\_ IDEC Rep/Distributor Contact: \_\_\_\_\_  
 Your Name: \_\_\_\_\_ PO number (if known): \_\_\_\_\_  
 Telephone: \_\_\_\_\_ IDEC Rep/Distributor Phone: \_\_\_\_\_  
 Fax & Email: \_\_\_\_\_ IDEC Rep/Distributor Fax & Email: \_\_\_\_\_

**NWAL**

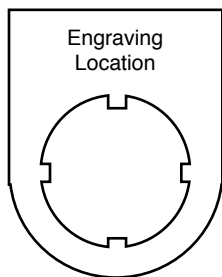

**Step 1.**

Choose Letter Size - 7/64" or 1/8".

**7/64"**  
Letter Size

11 characters max  
(for 7/64" size letters)

**1/8"**  
Letter Size

9 characters max  
(for 1/8" size letters)

Check the box for the letter size you want. Then write your lettering in box below checkboxes. Note: 1/8" size letters cannot exceed 9 characters.

**Step 2.**

Specify Quantity.

Enter the number of nameplates desired in the box on the right.

**Qty**

1 2 3 4 5 6 7 8 9 10 11

**Sample Letter Sizes**

7/64" Letters: A B C D

1/8" Letters: A B C D

**NWAQL**

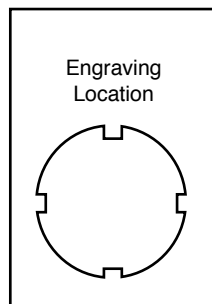

**Step 1.**

Choose Letter Size - 7/64" or 1/8".

**7/64"**  
Letter Size

11 characters max  
(for 7/64" size letters)

**1/8"**  
Letter Size

9 characters max  
(for 1/8" size letters)

Check the box for the letter size you want. Then write your lettering in box below checkboxes. Note: 1/8" size letters cannot exceed 9 characters.

**Step 2.**

Specify Quantity.

Enter the number of nameplates desired in the box on the right.

**Qty**

1 2 3 4 5 6 7 8 9 10 11

**Sample Letter Sizes**

7/64" Letters: A B C D

1/8" Letters: A B C D

**NWAS**

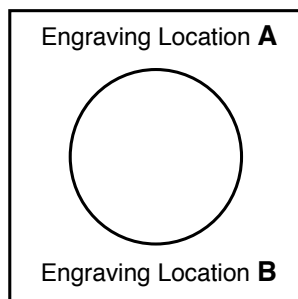

**Step 1.**

Choose Letter Size - 1/8" or 3/32".

**3/32"**  
Letter Size

20 characters max  
(for 3/32" size letters)

**1/8"**  
Letter Size

14 characters max  
(for 1/8" size letters)

Check the box for the letter size you want. Then write your lettering in box below checkboxes. Note: 1/8" size letters cannot exceed 14 characters.

**Step 2.**

Specify Quantity.

Enter the number of nameplates desired in the box on the right.

**Qty**

**Step 3.**

Specify Location.

Enter the location of engraving (A or B), in the box on the right.

**Location**

**Sample Letter Sizes**

3/32" Letters: A B C D

1/8" Letters: A B C D

1 2 3 4 5 6 7 8 9 10 11 12 13 14 15 16 17 18 19 20

**Switch Engraving Order Form – TW Series**

Copy this order form and use it to specify Letter Height, Maximum Number of Lines and Text to be engraved.

To ensure engraving accuracy, fax it to your IDEC representative or Distributor.

Your Company: \_\_\_\_\_  
 Name: \_\_\_\_\_  
 Address: \_\_\_\_\_  
 PO: \_\_\_\_\_

Telephone: \_\_\_\_\_  
 Fax: \_\_\_\_\_  
 Email: \_\_\_\_\_  
 Part Number to be Engraved: \_\_\_\_\_

Please check one of the boxes below to indicate your choice of engraving options:



ø29mm, ø40mm Mushroom Head

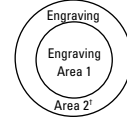

	# of Lines	Letter Height	Max. Characters Per Line
<input type="checkbox"/>	1	5/32	6
<input type="checkbox"/>		1/8	6
<input type="checkbox"/>	2	5/32	6
<input type="checkbox"/>		1/8	5
<input type="checkbox"/>	3	1/8	6
<input type="checkbox"/>	4	3/32	5

	# of Lines	Letter Height	Max. Characters Per Line
<input type="checkbox"/>	1	5/32	5
<input type="checkbox"/>		1/8	6
<input type="checkbox"/>	2	5/32	5
<input type="checkbox"/>		1/8	6
<input type="checkbox"/>	3	1/8	5
<input type="checkbox"/>	4	3/32	5

		# of Lines	Letter Height	Max. Characters Per Line
<input type="checkbox"/>	Engraving Area 1	1	5/32	5
<input type="checkbox"/>			1/8	5
<input type="checkbox"/>	Engraving Area 2	1	5/32	7
<input type="checkbox"/>			1/8	7



- Above mentioned specifications hold true for standard size pushbuttons (round and square).
- \*Engraving Area 2 can be engraved for 40mm mushroom Head non-Illuminated push button only.
- Engraving is done on the button itself for non-Illuminated push buttons and on marking plate for illuminated push buttons and pilot lights.
- Please enter text exactly how you want it engraved, take care to emphasize capital or small letters.

Enter text to be engraved:

Line 1: \_\_\_\_\_  
 Line 2: \_\_\_\_\_  
 Line 3: \_\_\_\_\_  
 Line 4: \_\_\_\_\_

**Sample Letter Sizes**

1/8 Letters: **OPEN**  
 5/32 Letters: **OPEN**

For IDEC Internal Use Only:  
 Work Order #: \_\_\_\_\_

## Accessories

## TW Series Accessories





Item	Appearance	Description/Usage	Part Number
Lamp Removal Tool		Rubber tool used to install or remove LED's and incandescent lamps	OR-55
Contact Block Remover		Used to remove contact blocks, transformers, lenses, and adaptors. Can also be used to determine panel thickness adjustment.	TW-KC1
Nut Locking Wrench		Used in OR-14 locking wrench to tighten locking nuts inside square bezel	TW-KQ2
Metal Bezel		Chrome plated bezels tighten onto operator (replacement for damaged bezels)	Standard octagonal units (chrome-pl.) AW-R8
			Full shroud octagonal units (chrome-pl.) AW-RF8
			Full shroud mushroom head units Ø 40mm AW-G4
Plastic Bezel		Black plastic bezels for square buttons (replacement for damaged bezels)	Round flush units (black plastic) AW-RP1B
			Round extended units (black plastic) AW-FP1B
			Square units (black plastic) AW-Q1B
			Square units with full shroud (black plastic) AW-QF1B
Boot/Cover		Used to cover and protect pushbuttons	Waterproof lens cover for square pilot lights APW00LN
			Waterproof lens cover for square illuminated buttons APW00L
			Clear boot for round flush units OC-31
			Clear boot for round extended units OC-32
			*In place of asterisk, specify <b>Rubber Boot</b> color: <b>B</b> (black), <b>G</b> (green), <b>R</b> (red), <b>Y</b> (yellow) - (nitril rubber) OCW-11*
Anti-Rotation Ring		Ring to prevent operator base from rotating in the mounting hole. Used when nameplate is not used	OGL-31
Mounting Hole Plug		Black rubber plug fills unused mounting holes in panel.	OB-31
Metallic Mounting Hole Plug		For plugging unused mounting holes in the panel. Tighten the attached locking ring to a torque of 12 kfg-cm maximum Degree of protection: IP66	LW9Z-BM
Replacement Keys		Pair of keys (#0)	TW-SK
Replacement Black Sleeve for Keyswitch			AKW2B-B
Metal Button Guard		Used on flush buttons to prevent inadvertent actuation	OLW-C



Switches & Pilot Devices

Signaling Lights

Relays & Sockets

Item	Appearance	Description/Usage		Part Number
Terminal Tab Adaptor		Quick- connect terminals	#250 (17/64" x 3/64") single tab	TW-FA1
Lock-out Adaptor		Used to provide lock-out protection for pushbuttons and knob selector switches: • Up to Ø 40mm mushroom head size (Padlock not included.) Not applicable for e-stops.		HW9Z-KL1
TW to TWTD Adaptor		Used to mount TW series control unit (except square units) Ø 7/8" (22mm) into a Ø 1-13/64" (30mm) panel cut-out.		TWN-A1R8
Replacement Marking Plates		White plastic engraving plate for use on all illuminated units (included in each lens). May be used to capture printed mylar insert (not supplied by IDEC) under lens face.	Round Pushbutton (Ø14mm)	ALW2B
			Round Pilot Light (Ø 14mm)	APW2B
			Mushroom Pushbutton (Ø 14mm)	ALW3B
			Square Pilot Light (q 21mm)	APQW1B
			Square Pushbutton (q 21mm)	ALQW2B

**Fingersafe Covers for TW Series**

Appearance	Description	Used with	Part Number
	Fingersafe terminal cover, adds 6mm to overall depth	APW and UPQW full voltage pilot lights	APS-PVL
	Fingersafe terminal cover, adds 3.5mm to overall depth. One required for each contact, only for rear-most terminals	Non-illuminated pushbuttons and selectors	HW-VL2
	Fingersafe terminal cover, adds 3mm to overall depth	APW and UPQW transformer pilot lights, and illuminated pushbuttons and illuminated selectors	HW-VL3
	Fingersafe terminal cover for contacts.	Full voltage illuminated pushbuttons and selectors	HW-VL4
	Fingersafe terminal cover for full voltage adaptor, adds 3 mm to depth	Full voltage illuminated pushbuttons and selectors	HW-VL5
	Fingersafe terminal cover for half size transformer adaptor, adds 3 mm to depth	Illuminated pushbuttons and selectors	HW-VL6

Timers

Contactors

Terminal Blocks

Circuit Breakers

Dimensions

Pushbuttons

Flush

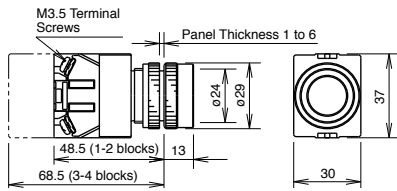

Extended

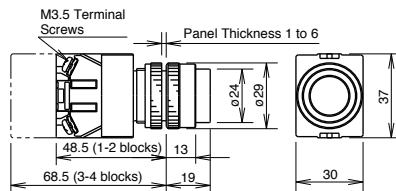

Extended with Full Shroud

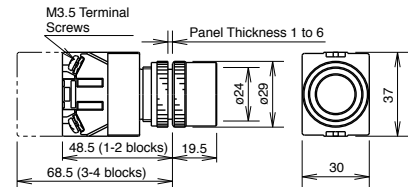

29mm Mushroom

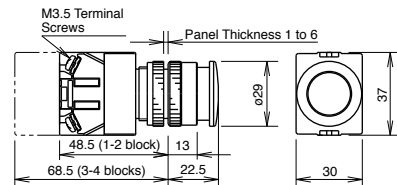

40mm Mushroom

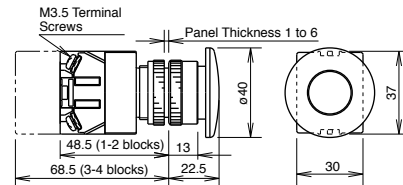

Mushroom with Full Shroud

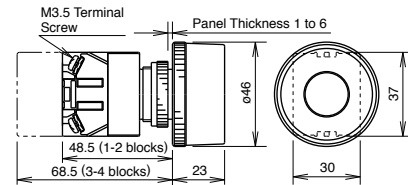

29mm Push-Lock-Turn-Reset

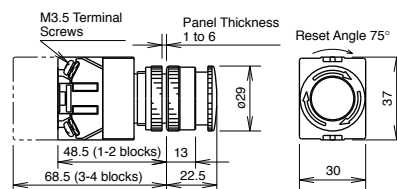

40mm Push-Lock-Turn-Reset

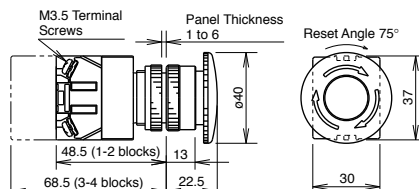

Keylock Push On/Off

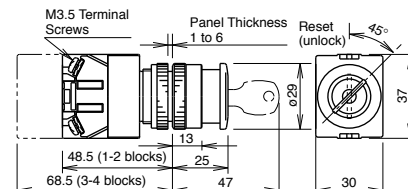

40mm Pushlock Key reset

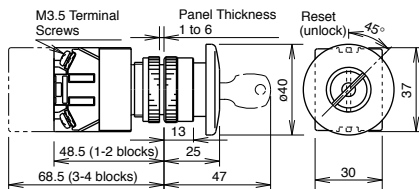

40mm Push-Pull

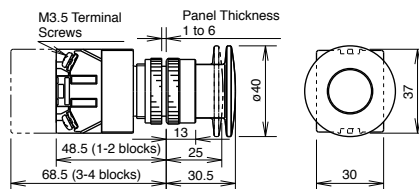

Square Flush

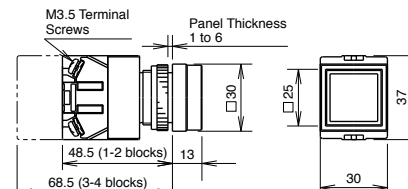

Square Extended

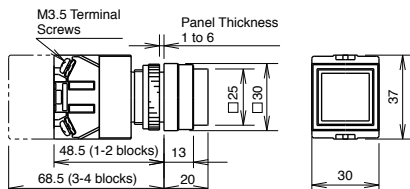

Selector Switches

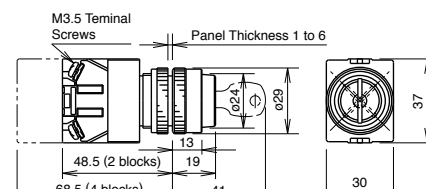
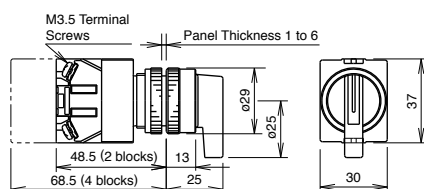
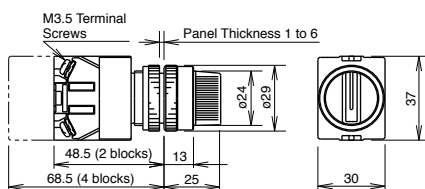

Switches & Pilot Devices

Signaling Lights

Relays & Sockets

Timers

Contactors

Terminal Blocks

Circuit Breakers

Dimensions continued

Illuminated Pushbuttons

Extended

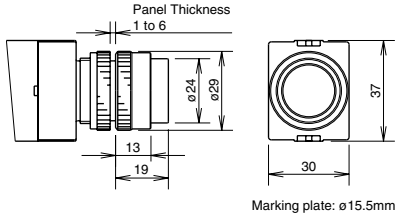

Extended with Full Shroud

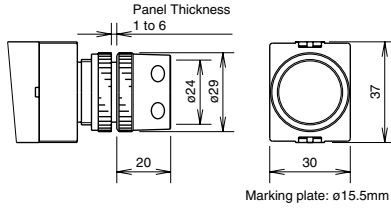

Square Extended

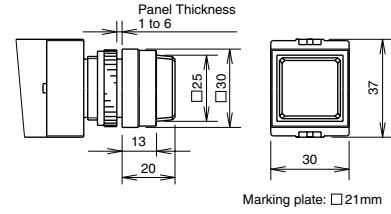

29mm Push-Turn-Reset

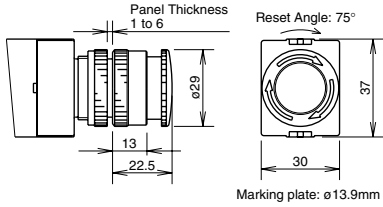

40mm Push-Turn-Reset

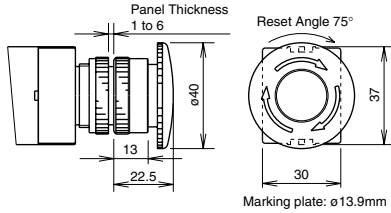

Mushroom

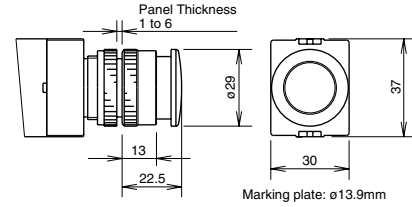

Push-Pull

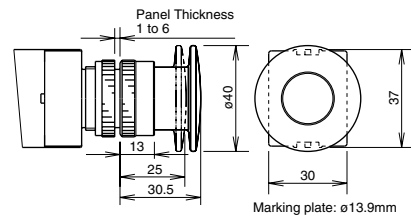

Illuminated Selector Switches

1 Contact Block with Full Voltage Adaptor

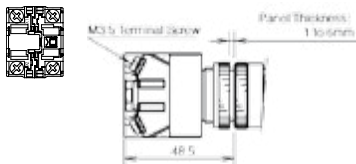

Transformer (2 blocks)

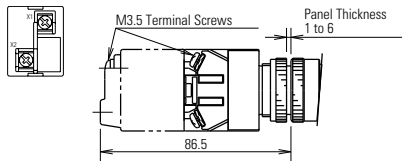

1 Contact Block with Half Size Transformer

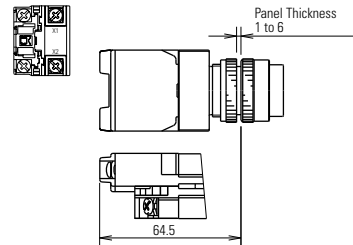

2 Contact Blocks with Full Voltage Adaptor Transformer (4 blocks)

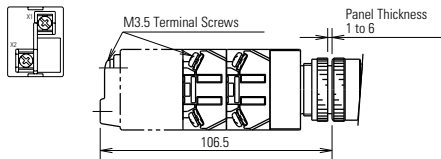
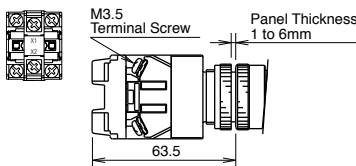

2 Contact Blocks with Half Size Transformer

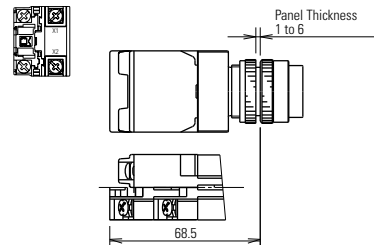

3 Contact Blocks with Full Voltage Adaptor

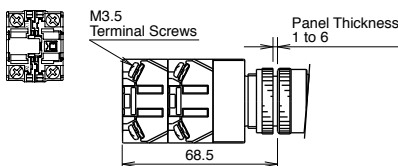

4 Contact Blocks with Full Voltage Adaptor

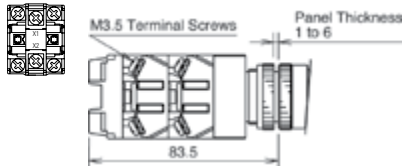

3 Contact Blocks with Half Size Transformer

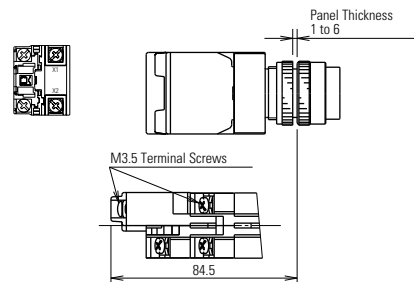

Dimensions continued

Pilot Lights

Round Flush APW1 Full Voltage

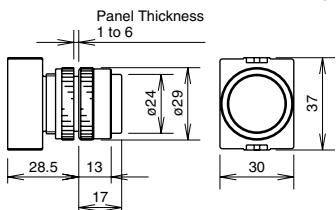

Round Flush APW1 Transformer

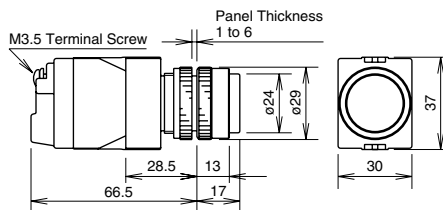

Round Flush Marking Type APW1B Full Voltage

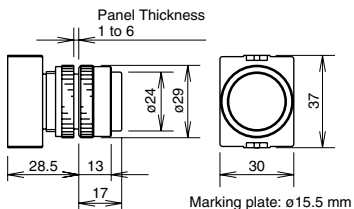

Round Flush Marking Type APW1B Transformer

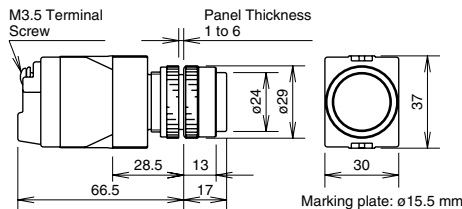

Dome APW2 Full Voltage

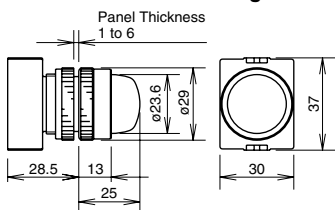

Dome APW2 Transformer

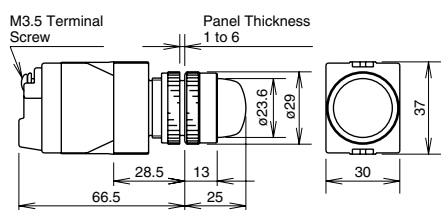

Square Flush Marking Type APQW1B Full Voltage

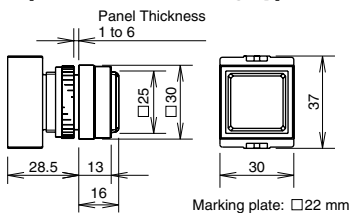

Square Flush Marking Type APQW1B Transformer

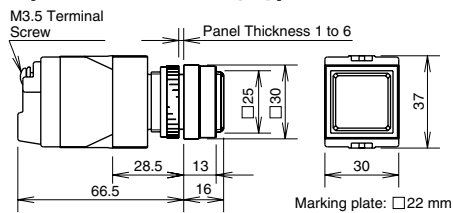

Illuminated Selector Switches

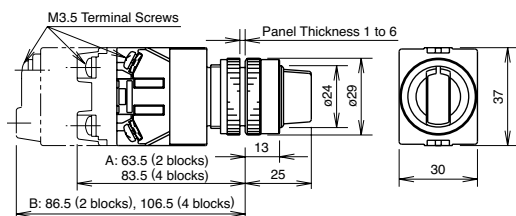

Switches & Pilot Devices

Signaling Lights

Relays & Sockets

Timers

Contactors

Terminal Blocks

Circuit Breakers

### Dimensions continued

#### Panel Cut-Out

Diagram	Part	Dimension			
		A	B	C	D
	Pushbuttons	$\varnothing$ 0.137" (3.5mm)	1.95" (50mm); 1.76" (45mm) minimum	$\varnothing$ 0.878" (22.3mm)	1.17" (30mm) Std. Octagonal
	Pilot Light				> 1.56" (40mm) Large Mushroom
	Illuminated Pushbuttons				
	Selector Switches				
	Illuminated Selector Switches				1.17" (30mm) *See note.

1. The  $\varnothing$  0.137" ( $\varnothing$  3.5mm) recess is necessary when either the nameplate or anti-rotation ring is used.
2. \* > 1.404" (36mm) for 2- or 3-position.  
> 1.95" (50mm) for 4- or 5-position.

#### Accessory Dimensions

##### OGL-31

##### Anti-Rotation Ring

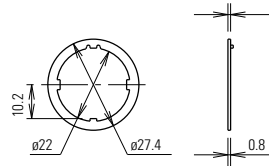

##### OLW-C

##### Metal Button Guard

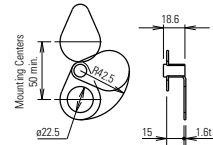

##### OCW-11

##### Pushbutton Rubber Boot

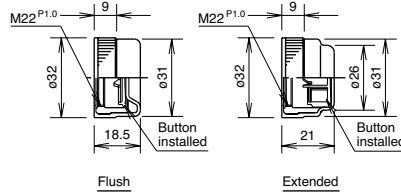

##### OB-31

##### Mounting Hole Rubber Plug

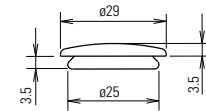

##### HW9Z-KL1

##### Lock-out Adaptor

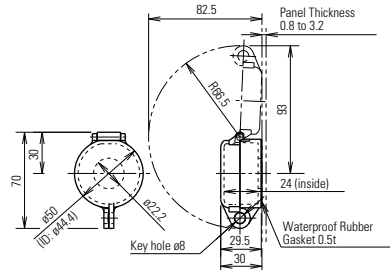

##### AW-RP1B

##### Round Plastic Bezel



##### AW-FP1B

##### Round Plastic w/Full Shroud



##### AW-QF1B

##### Square Full Shroud

#### Finger-Safe Cover Dimensions

##### HW-VL6

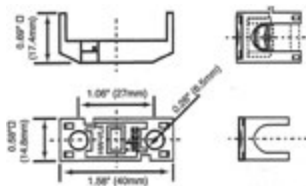

##### HW-VL5

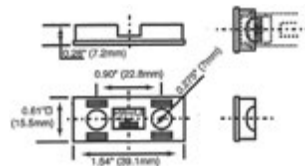

##### HW-VL4

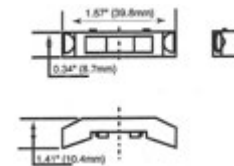

##### HW-VL3

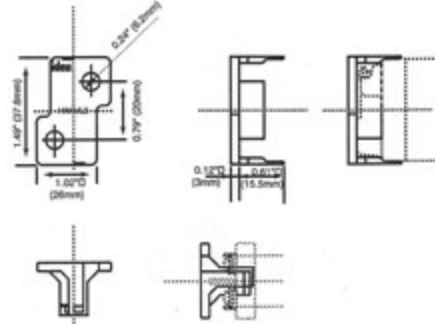

##### HW-VL2

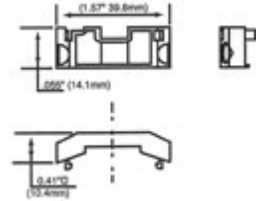

##### APS-PVL

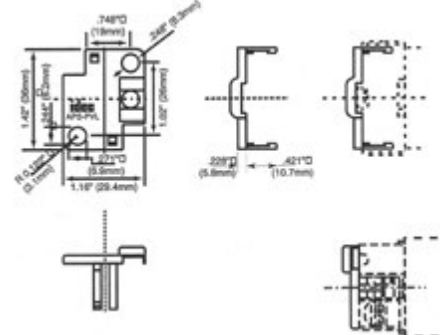

Component Construction and General Instructions – TW Series

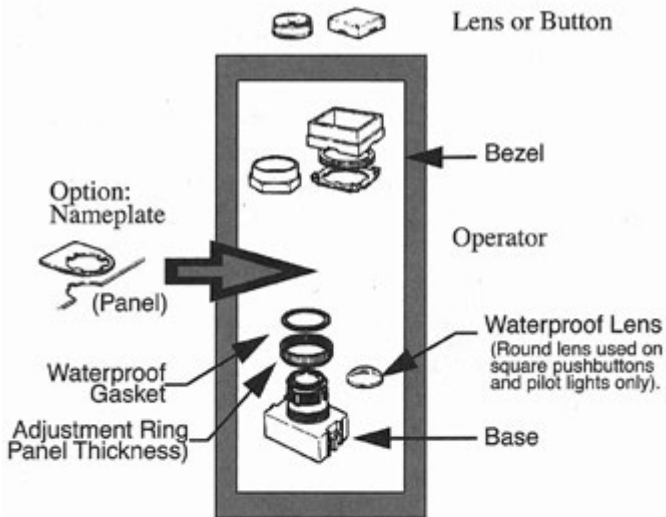

Instructions for Switches and Pilot Devices

TW Series: Adjustment for Panel Thickness

The panel thickness ring provides adjustment from 0.04" to 0.24" (1 to 6mm) in 0.004" (0.1mm) increments. Rotate the ring until the markings around the periphery are aligned for the desired thickness, as shown below.

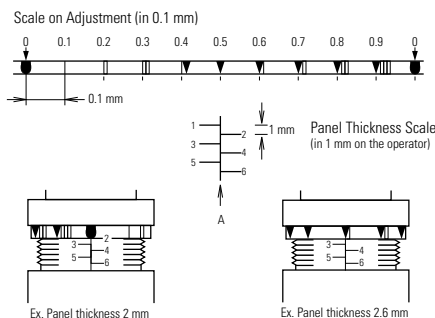

**Note:** When a nameplate or an anti-rotation ring is used, add 0.03" (0.8mm) to the panel thickness dimension.

An adjustment for panel thicknesses shown below can be made quickly by using the contact block remover tool.

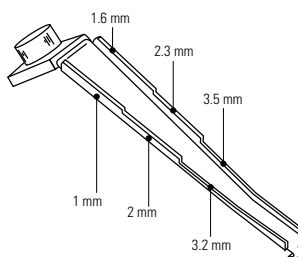

Tool TW-KC1

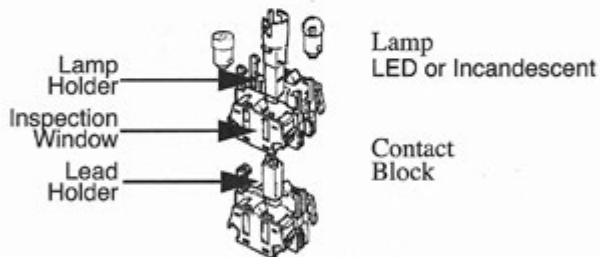
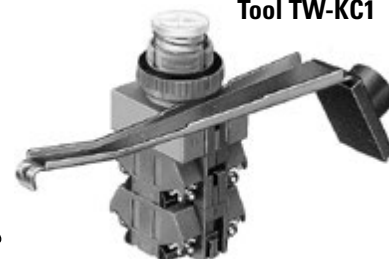

Options

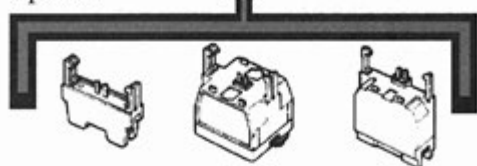

**Full Voltage Adaptor:**  
Used with full voltage LED or incandescent.

**Full-Size Transformer:**  
Used with incandescent/LED – even number of contact blocks.

**Half-Size Transformer:**  
Used with incandescent – odd number of contact blocks.

Instructions continued

Pilot Lights and Pushbuttons

IMPORTANT: Install the body of the TW control unit with the panel thickness scale facing up.

Octagonal and Round Bezels

Octagonal and round bezels screw into the operator. Use a locking ring wrench (optional) for secure tightening and easy removal. Round flush and extended buttons snap onto the operator base. Mushroom buttons screw onto the operator base.

Every round lens can be used with or without legend markings. Engraving can be done on a white translucent plate which is placed in the lens, or clear mylar can be printed and placed in the lens.

Round Marking Unit

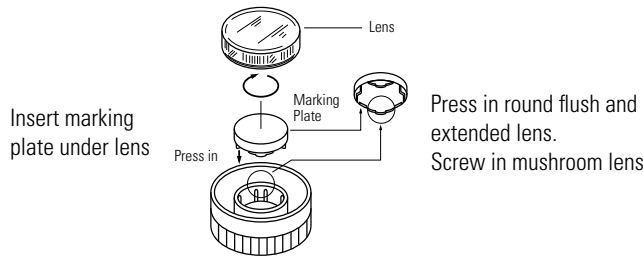

Square Bezels

Square bezels are installed in a 3-step procedure. First install the base plate from the front. Then install the lock nut using the nut locking wrench (optional). Finally, install the square bezel, which snap-fits onto the base plate. Square buttons also snap onto the operator base.

Every square lens can be used with or without legend markings. Engraving can be done on a white translucent plate which is placed in the lens, or clear mylar can be printed and placed in the lens. Square units include a round waterproof lens which screws into the operator. The square outer lens snaps on.

Square Marking Units

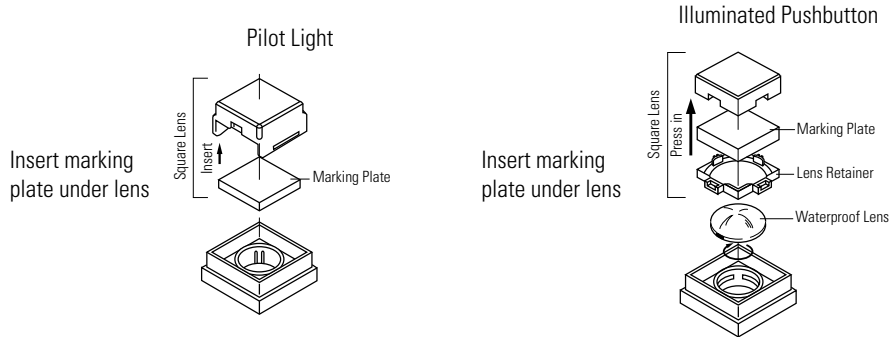

To remove square lens from operator, place a screwdriver under the indentation on the side of the lens. To remove the marking plate, place a screwdriver under the indentation and lift out the plate. The lens retainer can be removed by pressing a 3/16" screwdriver into one of the recesses.



Marking Plate Engraving Area

Shape	Engraving Area	Used With	Part Number
Round	Ø 0.55" (14mm)	Illuminated pushbuttons	ALW2B
	Ø 0.55" (14mm)	Pilot lights	APW2B
Mushroom	Ø 0.55" (14mm)	Illuminated mushroom	ALW3B
Square	□ 0.83" (21mm)	Square pilot lights	APQW1B
Square	□ 0.83" (21mm)	Square illuminated pushbuttons	ALQW2B



Instructions, continued

Selector Switches

The operator shaft of each unit has a recess to identify in which direction to install the handle. Align the handle with the recess. Press color insert (TW-HC1) into the handle and then press handle into the operator, as shown below.

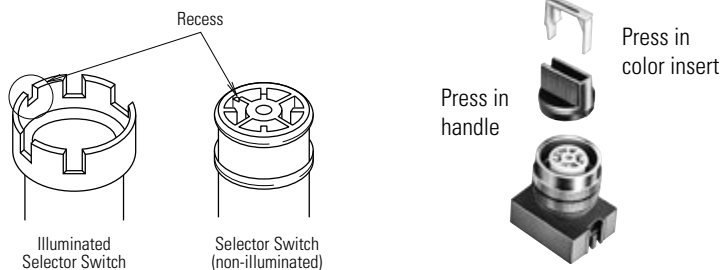

Remove color insert before pulling out the handle.

Standard Operating Positions

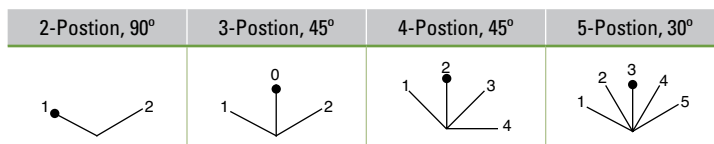

Positions: Non-Illuminated 3-Position Operators

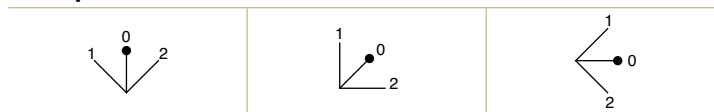

Installation

TW Pilot Lights

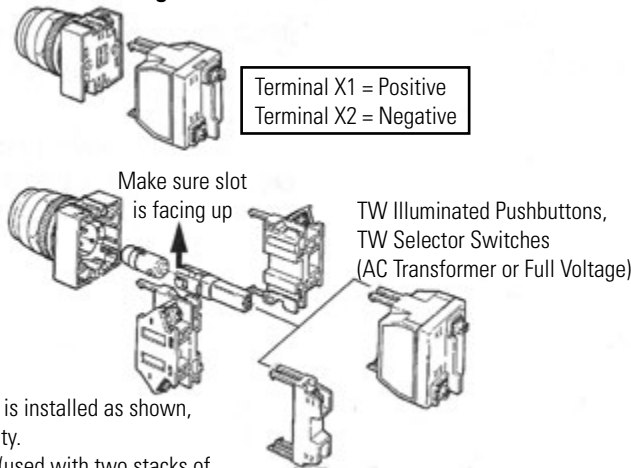

Installation of LED Illuminated Units

AC transformers are recommended for use in areas subjected to inductive noise. When using full voltage types, install a protection diode as shown below. (Diode with DC power supply to protect against surges and noise.)



Make sure that LED illuminated units are installed with correct polarity, as indicated at the terminals.

## Enclosures for XW, HW & TW 22mm Switches and Pilot Devices

### Key features:

- Three compact sizes (mm): 76 x 76, 140 x 76 and 200 x 76
- Available in 1, 2, 3, 4 or 5 mounting hole configurations
- Easy installation: panel, wall or frame mountable
- Polycarbonate enclosure cover and base, stainless steel screws
- UL Listed, RoHS Compliant
- IP65 and Type 4X rated (when installed with IP65 or Nema Type 4X unit)
- Class II electric shock protection (when installed with applicable unit)
- Ideal for high temperatures (-25 to +60°C) and corrosive environments



### Specifications

Operating Conditions	Ambient temperature	-25 to +60°C (no freezing)
	Relative humidity	45 to 85%RH (no condensation)
	Storage temperature	-40 to +80°C (no freezing)
	Degree of pollution	3
Degree of Protection	IP65 (when IP65 switches and pilot devices are installed) Type 4X Indoor Use Only (when Type 4X switches and pilot devices are installed)	
Electric Shock Protection	Class II (when class II switches and pilot devices are installed)	
Material	Cover and base	Polycarbonate
	Cover mounting screws	Stainless steel
Applicable Switches and Pilot Devices	HW, TW and XW series switches, pilot devices and accessories (see note below)	
Weight (approx.)	76mm type: 125g (FB1W-111Z) 140mm type: 184g (FB2W-211Z) 200mm type: 243g (FB3W-311Z)	



Choose switches, pilot devices and accessories that match the mounting hole centers, effective depth behind the cover, and the thickness of the cover where switches and pilot devices are installed (3 mm). Enclosures with 30 or 36mm mounting hole centers may limit the knob orientation of selector switches because the contact blocks can be mounted in one direction only on these mounting centers.

### Enclosure Part Numbers

Size (mm)	Description	Part Number	Distance Between Hole Centers (mm)
76 x 76 x 59.5	Enclosure 1 hole, Yellow	FB1W-111Y	-
	Enclosure 1 hole, Beige	FB1W-111Z	-
140 x 76 x 59.5	Enclosure 2 hole, Beige	FB2W-211Z	50
	Enclosure 3 hole, Beige	FB2W-312Z	30
200 x 76 x 59.5	Enclosure 3 hole, Beige	FB3W-311Z	50
	Enclosure 4 hole, Beige	FB3W-413Z	36
	Enclosure 5 hole, Beige	FB3W-512Z	30

### Accessories

Description	Part Number
Plug Adaptor 13.5mm	HW9Z-PG135
Mounting Bracket	FB9Z-PK1



Connectors and nuts are not supplied with accessories.

### Switch and Pilot Device Accessories

Series	Description	Part Number
HW Series	Nameplate	HWAM, HWAQ, HWAS, HWAV
	Marking plate for nameplate	HWNP
	Anti-rotation ring	HW9Z-RL
	EMO switch guard	HW9Z-KG1, HW9Z-KG2, HW9Z-KG3, HW9Z-KG4
	Switch cover	HW9Z-K1, HW9Z-K11
	Pushbutton clear boot	OC-31, OC-32
	Padlock cover	HW9Z-KL1
XW Series E-Stops	Nameplate	HWAV
	EMO switch guard	HW9Z-KG1, HW9Z-KG2, HW9Z-KG3, HW9Z-KG4
	Anti-rotation ring	HW9Z-RL
TW Series	Nameplate	NWA, NWAQ, NWAS-0, NWAL-0, NWAQL-0, NWAV
	Anti-rotation ring	OGL-31
	Metal button guard	OLW-C
	Pushbutton clear boot	OC-31, OC-32
	Button cover	OCW-11
Padlock cover	HW9Z-KL1	

External Dimensions (mm)

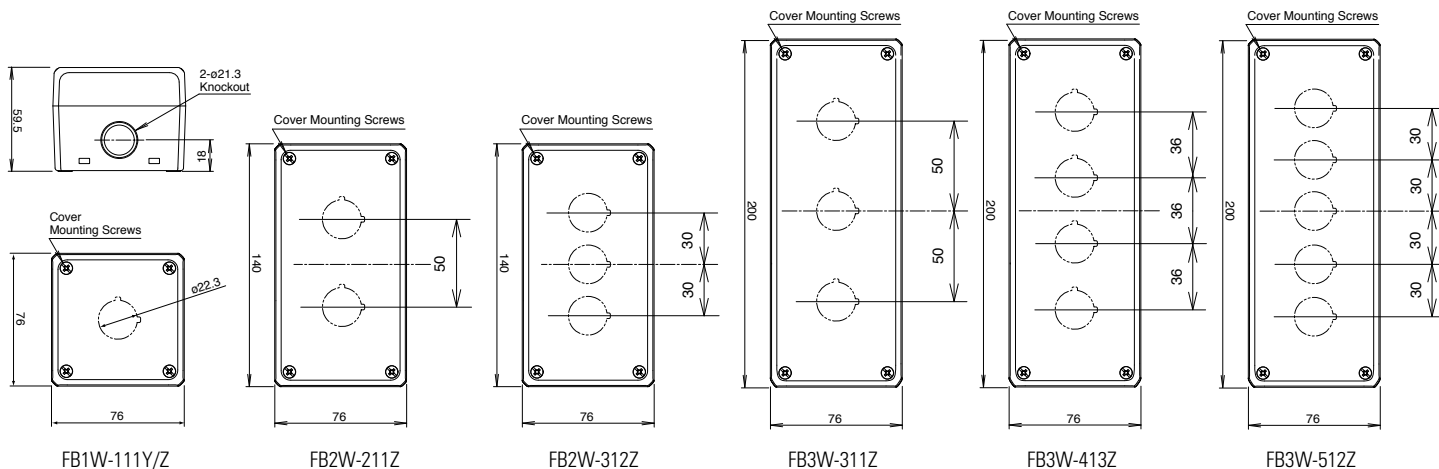

Internal Dimensions (mm)

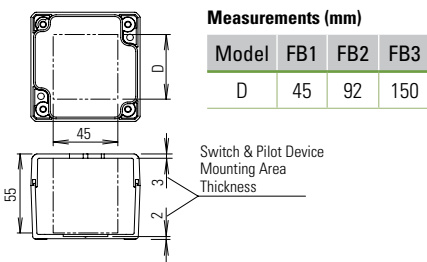

External Back Dimensions (mm)

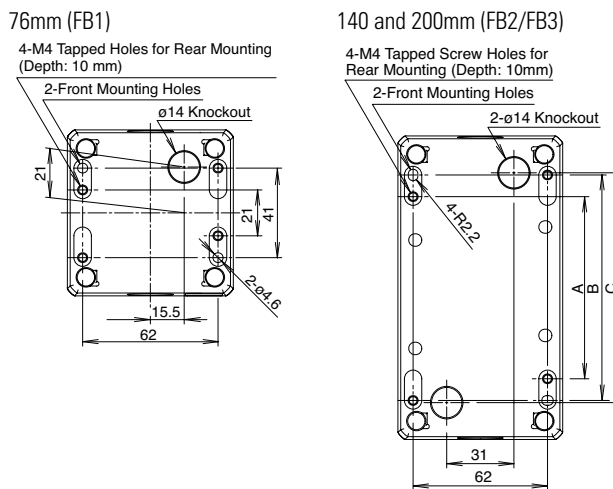

Measurements (mm)

Model	FB2	FB3
A	84	144
B	104	164
C	106	166

Mounting

FB9Z-PK1 Frame Mounting Adapter

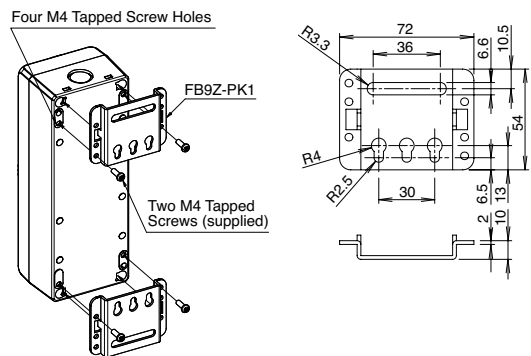

Mounting Hole Dimensions

Model	FB1	FB2	FB3	FB2/FB3
		50mm Mounting Centers	36/50mm Mounting Centers	30mm Mounting Centers
Shape				

### 30mm XN E-Stops

**Key features:**

- Plastic bezel, metallic padlock and flush bezel available
- Install up to 20 padlocks (XN4E)
- ø40, ø44 or ø60mm Mushroom heads available
- IDEC's original "safe break action" ensures that the contacts stay open when the contact block is detached from the operator.
- Safety-lock mechanism (IEC60947-5-5, 6.2)
- 2-in-1: Push-to-lock, Pull/Turn-to-Reset
- Push-ON LED model allows E-Stops to be illuminated only when latched
- Direct Opening Action mechanism (IEC60947-5-5, 5.2, IEC60947-5-1, Annex K)
- Very short panel depth
- Degree of protection IP65 (IEC60529)
- RoHS compliant (EU directive 2002/95/EC).
- XN4E series complies with OSHA and ISO 12100-2:2003 standards
- UL, c-UL listed, EN compliant
- UL NISD category emergency type device (File# E305148)





**Specifications**



Applicable Standards	IEC60947-5-1, EN60947-5-1, IEC60947-5-5, EN60947-5-5, UL508, UL991, CSA C22.2 No. 14	
Operating Temperature	Non-illuminated: -25 to +60°C (no freezing), Illuminated: -25 to +55°C (no freezing)	
Operating Humidity	45 to 85% RH (no condensation)	
Storage Temperature	-45 to +80°C	
Operating Force	<b>XN1E, XN5E</b> Push-to-lock: 32N Pull-to-reset: 21N Turn-to-reset: 0.27 N·m	<b>XN4E</b> Push-to-lock: 32N Pull-to-reset: N/A Turn-to-reset: 0.4 N·m
Minimum Force Required for Direct Opening Action	80N	
Min Operator Stroke Required for Direct Opening Action	4mm	
Maximum Operator Stroke	4.5mm	
Contact Resistance	50mΩ maximum (initial value)	
Contact Material	Gold plated silver	
Insulation Resistance	100MΩ minimum (500V DC megger)	
Impulse Withstand Voltage	2.5kV	
Pollution Degree	3	
Operation Frequency	900 operations/hour	
Shock Resistance	Operating extremes: 150m/s <sup>2</sup> (15G), Damage limits: 1000m/s <sup>2</sup> (100G)	
Vibration Resistance	Operating extremes: 10 to 500Hz, amplitude 0.35mm acceleration 50m/s <sup>2</sup> Damage limits: 10 to 500Hz, amplitude 0.35mm acceleration 50m/s <sup>2</sup>	
Mechanical Life	250,000 operations minimum	
Electrical Life	100,000 operations minimum, (250,000 operations minimum @ 24V AC/DC, 100mA)	
Degree of Protection	Operator: IP65 (IEC60529) Terminal: IP20 (when XW9Z-VL2MF is installed)	
Terminal Style	M3.0 screw terminal	
Recommended Tightening Torque for Locking Ring	2.5N·m	
Wire Size	16 AWG max	
Weight	XN1E: Plastic bezel: 83g (ø40 mm), 93g (ø60 mm) XN5E: Flush bezel: 89g XN4E: Padlock type: 20g	

Part Numbers



XN1E Plastic Bezel Type E-Stops (push-pull/twist reset)

Style	Operator Type	Main Contact	Monitor Contact	Part Number
Non-Illuminated 	40mm Mushroom	1NC	1NO	XN1E-BV411MR
		2NC	-	XN1E-BV402MR
		2NC	2NO	XN1E-BV422MR
		3NC	1NO	XN1E-BV413MR
	60mm Mushroom	4NC	-	XN1E-BV404MR
		1NC	1NO	XN1E-BV511MR
		2NC	-	XN1E-BV502MR
		2NC	2NO	XN1E-BV522MR
Illuminated 	40mm Mushroom LED (24V AC/DC)	3NC	1NO	XN1E-BV513MR
		4NC	-	XN1E-BV504MR
		1NC	1NO	XN1E-LV411Q4MR
		2NC	-	XN1E-LV402Q4MR
	40mm Mushroom Push-ON LED (24V AC/DC)	2NC	2NO	XN1E-LV422Q4MR
		3NC	1NO	XN1E-LV413Q4MR
		4NC	-	XN1E-LV404Q4MR
		2NC	1NO	XN1E-TV412Q4MR

XN4E Padlock Type E-Stops (push twist reset only)

Style	Operator Type	Main Contact	Monitor Contact	Part Number
Non-Illuminated 	44mm Mushroom	1NC	1NO	XN4E-BL411MR
		2NC	-	XN4E-BL402MR
		2NC	2NO	XN4E-BL422MR
		3NC	1NO	XN4E-BL413MR
		4NC	-	XN4E-BL404MR
Illuminated 	44mm Mushroom LED (24V AC/DC)	1NC	1NO	XN4E-LL411Q4MR
		2NC	-	XN4E-LL402Q4MR
		2NC	2NO	XN4E-LL422Q4MR
		3NC	1NO	XN4E-LL413Q4MR
	44mm Mushroom Push-ON LED (24V AC/DC)	4NC	-	XN4E-LL404Q4MR
		2NC	1NO	XN4E-TL412Q4MR

XN5E Flush Bezel Type E-Stops (push-pull/twist reset)

Style	Operator Type	Main Contact	Monitor Contact	Part Number
Non-Illuminated 	40mm Mushroom	1NC	1NO	XN5E-BV411MR
		2NC	-	XN5E-BV402MR
		2NC	2NO	XN5E-BV422MR
		3NC	1NO	XN5E-BV413MR
		4NC	-	XN5E-BV404MR
Illuminated 	40mm Mushroom LED (24V AC/DC)	1NC	1NO	XN5E-LV411Q4MR
		2NC	-	XN5E-LV402Q4MR
		2NC	2NO	XN5E-LV422Q4MR
		3NC	1NO	XN5E-LV413Q4MR
	40mm Mushroom Push-ON LED (24V AC/DC)	4NC	-	XN5E-LV404Q4MR
		2NC	1NO	XN5E-TV412Q4MR

**Contact Ratings**

Rated Insulation Voltage (Ui)		250V				
Rated Current (Ith)		5A				
Rated Operating Voltage (Ue)		30V	125V	250V		
Rated Operating Current	Main Contacts (NC)	AC 50/60Hz	Resistive Load (AC-12)	–	5A	3A
			Inductive Load (AC-15)	–	3A	1.5A
	DC	Resistive Load (DC-12)	2A	0.4A	0.2A	
		Inductive Load (DC-13)	1A	0.22A	0.1A	
Rated Operating Current	Monitor Contacts (NO)	AC 50/60Hz	Resistive Load (AC-12)	–	1.2A	0.6A
			Inductive Load (AC-14)	–	0.6A	0.3A
	DC	Resistive Load (DC-12)	2A	0.4A	0.2A	
		Inductive Load (DC-13)	1A	0.22A	0.1A	

1. Minimum applicable load: 5V AC/DC, 1mA (reference value).
2. The rated operating currents are measured at resistive/inductive load types specified in IEC 60947-5-1.

**Illuminated Unit LED Ratings**

Model	Operating Voltage	Current
XN	24V AC/DC ±10%	15mA

**Depth Behind the Panel**

Model	Depth (mm)	Description
XN1E	47.7	1 - 4 contacts, plastic bezel
XN5E	60.4	1 - 4 contacts, flush bezel
XN4E	61.4	1 - 4 contacts, padlock

**Mounting Hole Layout**

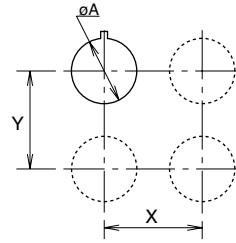

**Measurements**

Size	øA	X & Y
XN1E, XN5E	30.5 <sup>+0.5</sup>	70mm min
XN4E	30.5	For XN4E, determine the values according to the size and number of padlocks and hasp.

**Panel Cutout**

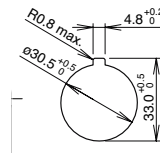

**Part Numbers**

**XN1E - LV 4 02 Q4 MR**

**Bezel**  
 1: Plastic Bezel  
 4: Padlock  
 5: Flush Bezel

**Illumination**  
 XN1E, XN5E  
 BV: Non-Illuminated  
 LV: Illuminated LED  
 TV: Illuminated Push-ON LED  
 XN4E  
 BL: Non-Illuminated  
 LL: Illuminated LED  
 TL: Illuminated Push-ON LED

**Mushroom Size**  
 4: ø40mm: XN1E, XN5E  
 ø44mm: XN4E  
 ø60mm  
 (XN1E non-illuminated only)

**Contact Configuration\***  
 11: 1NO - 1NC  
 02: 2NC  
 13: 1NO - 3NC  
 22: 2NO - 2NC  
 04: 4NC  
 12: 1NO-2NC (Push-ON LED only)

**Voltage Code**  
 Blank: Non-Illuminated  
 Q4: 24V AC/DC (Illuminated & Push-ON LED type)

\*Contact IDEC for additional configurations.

**Terminal Arrangements (Bottom View)**

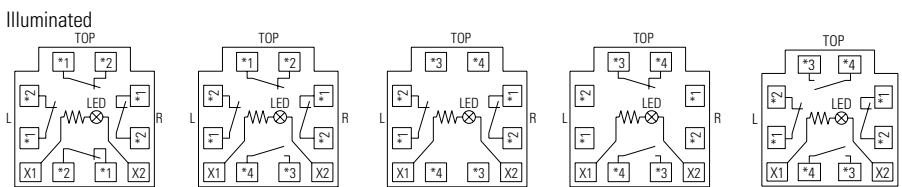
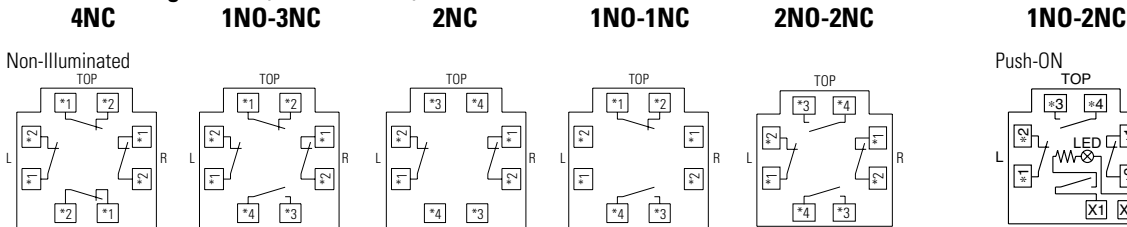

**Terminal Marking Description**

• Contact Type  
 1-2: NC main contact  
 3-4: NO monitor contact

• Contact Number (1-4)  
 Starting with the contact on TOP in a counterclockwise direction.  
 Note:  
 1: contact on the TOP  
 2: contact on the Left  
 3: contact on the Bottom  
 4: contact on the Right

(Example: 1NO-3NC contact)



Dimensions (mm)

XN1E Non-Illuminated (with terminal cover)

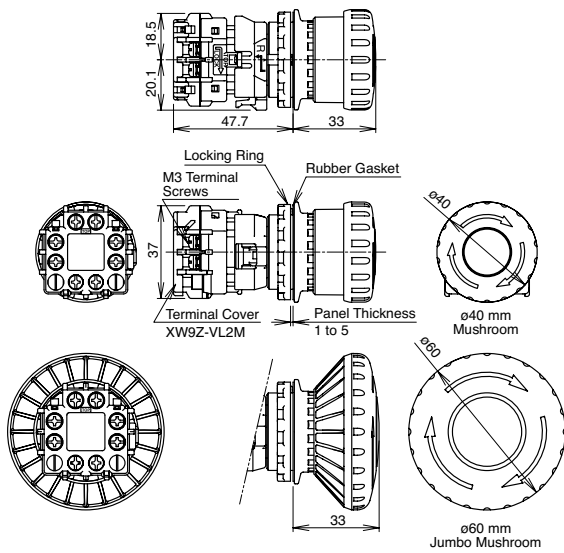

XN1E Illuminated/Push-ON (with terminal cover)

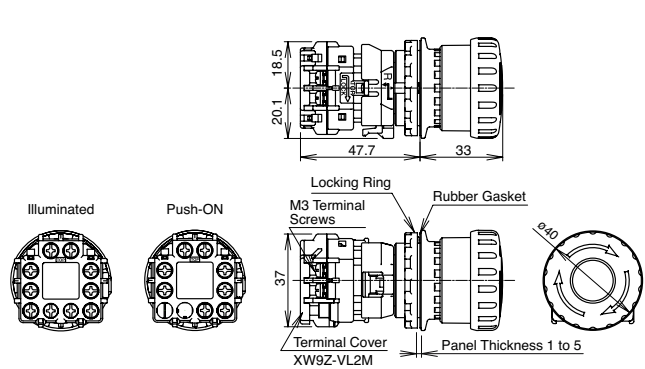

XN5E Non-Illuminated (with terminal cover)

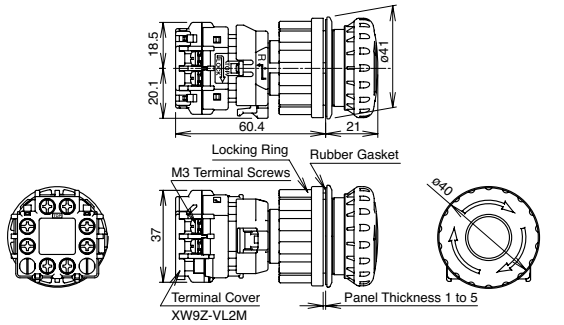

XN5E Illuminated (with terminal cover)

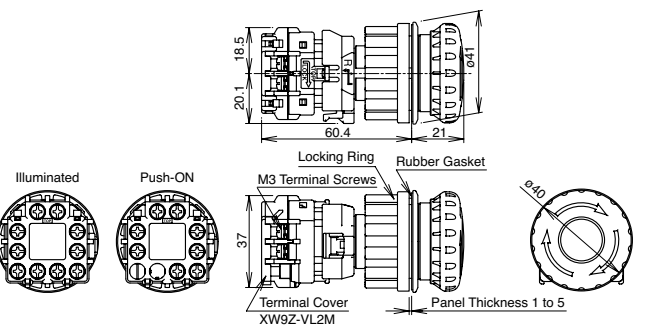

XN4E Non-Illuminated (with terminal cover)

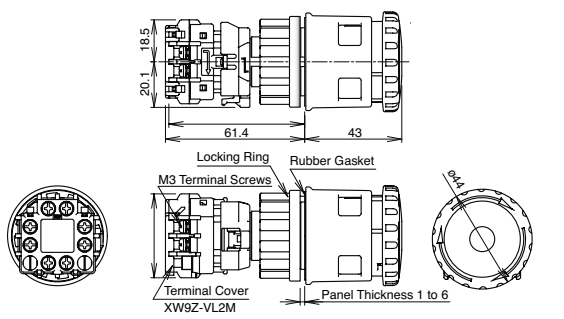

XN4E Illuminated (with terminal cover)

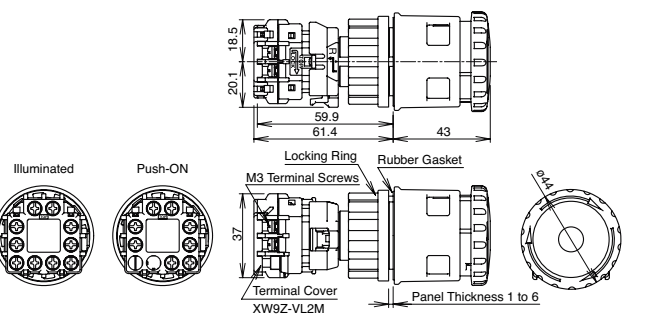

Accessories

Item	Description	Part Number
	Locking Ring Wrench	XN9Z-T1
	Locking Ring Twist Wrench	TWST-T1
	Lockout Hasp	XN9Z-HASP421

Nameplates

Item	Part No.	Legend	Mounting Panel Thickness
	HNAV-0	(blank)	XN4E: 1.0 to 4.5 mm
	HNAV-27	EMERGENCY STOP	XN1E, XN5E: 1.0 to 3.5 mm

Item	Description	Part Number
	Terminal Cover for Contact Block	XW9Z-VL2M
	IP20 Fingersafe Cover	XW9Z-VL2MF



## Operating Instructions

### Removing the Contact Block

First unlock the operator button. Grab the yellow bayonet ring ① and pull back the bayonet ring ②. Turn counterclockwise ③. The latch pin clicks ②, then turn the contact block counterclockwise and pull out ③.

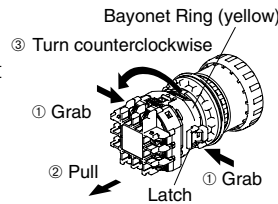

### Notes for removing the contact block

1. Do not attempt to remove the contact block while the operator is latched, otherwise the switch may be damaged.
2. When the contact block is removed, the monitor contact (NO contact) is closed.
3. While removing the contact block, do not use excessive force, otherwise the switch may be damaged.
4. An LED lamp is built into the contact block for illuminated pushbuttons. When removing the contact block, pull the contact block straight to prevent damage to the LED lamp. If excessive force is used, the LED lamp may be damaged and fail to light.

### Panel Mounting

Remove the locking ring from the operator and check that the rubber gasket is in place. Insert the operator from panel front into the panel hole. Face the side without thread on the operator with TOP marking upward, and tighten the locking ring using ring wrench XN9Z-T1 or TWST-T1 to a torque of 2.5 N·m maximum.

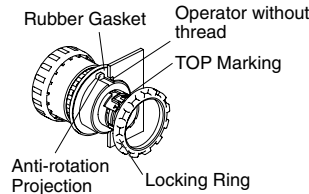

### When using a nameplate

When using a nameplate HNAV-□, break the projection from the nameplate using pliers.



### Installing the Contact Block

First unlock the operator button. Align the small ▼ marking on the edge of the operator with the small ▲ marking on the yellow bayonet ring. Hold the contact block, not the bayonet ring. Press the contact block onto the operator and turn the contact block clockwise until the bayonet ring clicks.

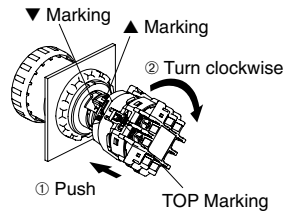

### Notes for installing the contact block

1. Do not attempt to install the contact block when the operator is latched, otherwise the switch may be damaged.
2. Make sure that the bayonet ring is in the locked position.

### Installing & Removing Terminal Covers

#### XW9Z-VL2M

To install the terminal cover, align the TOP marking on the terminal cover with the TOP marking on the contact block. Place the two projections on the bottom side of the contact block into the slots in the terminal cover. Press the terminal cover toward the contact block.

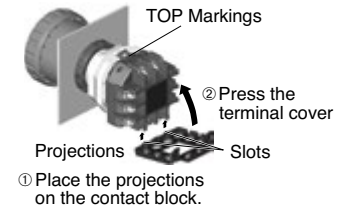

To remove the terminal cover, pull out the two latches on the top side of the terminal cover. Do not exert excessive force to the latches, otherwise the latches may break.

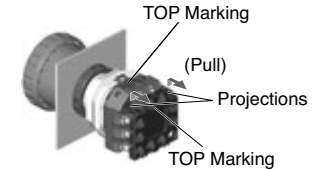

#### IP20 Fingersafe Terminal Cover XW9Z-VL2MF

To install the IP20 fingersafe terminal cover, align the TOP marking on the cover with the TOP marking on the contact block, and press the cover toward the contact block.

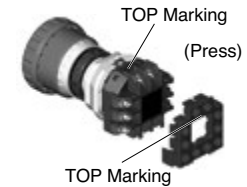

1. Once installed, the XW9Z-VL2MF cannot be removed.
2. With the XW9Z-VL2MF installed, crimping terminals cannot be used.
3. The XW9Z-VL2MF cannot be installed after wiring.
4. Make sure that the XW9Z-VL2MF is securely installed. IP20 cannot be achieved when installed loosely, and electric shock may occur.

### Notes for Operation

When using the XN emergency stop switches in safety-related part of a control system, observe safety standards and regulations of the relevant country or region. Also be sure to perform a risk assessment before operation.

### Wiring

Tighten the M3 terminal screws to a torque of 0.6 to 1.0 N·m.

### Contact Bounce

When the button is reset by pulling or turning, the NC main contacts will bounce. When pressing the button, the NO monitor contacts will bounce.

When designing a control circuit, take the contact bounce time into consideration (reference value: 20 ms).

### LED Illuminated Switches

LED lamp is built into the contact block and cannot be replaced.

### Handling

Do not expose the switch to excessive shocks and vibrations, for example by operating the switch with tools. Otherwise the switch may be deformed or damaged, causing malfunction or operation failure.

### Screw Terminal Type

1. AWG18 to 16
2. Tighten the M3 terminal screw to a tightening torque of 0.6 to 1.0 N·m.

Operating Instructions, continued

Screw Terminal Type

1. Wire thickness: 0.75 to 1.25 mm<sup>2</sup> (AWG18 to 16)

Applicable Crimping Terminals

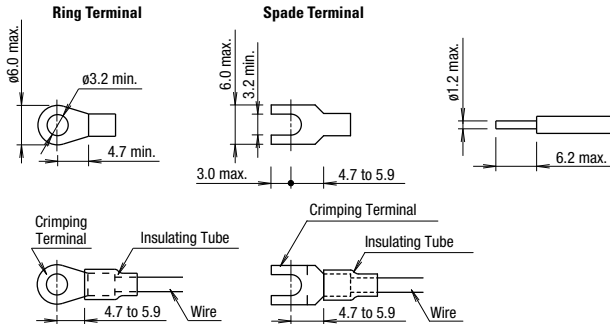

Solid Wire

To remove the terminal cover, pull out the two latches on the top side of the terminal cover. Do not exert excessive force to the latches, otherwise the latches may break.

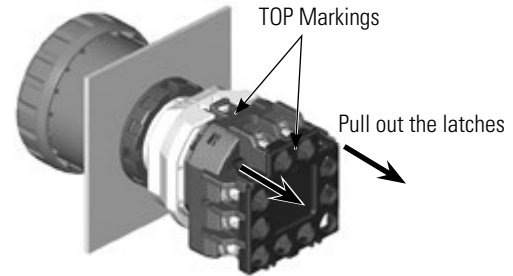

IP20 Protection Terminal Cover XW9Z-VL2MF

To install the IP20 protection cover, align the TOP marking on the cover with the TOP marking on the contact block, and press the cover toward the contact block.

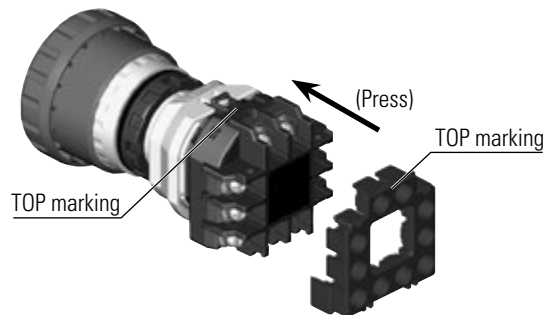

1. Once installed, the XW9Z-VL2MF cannot be removed.
2. The XW9Z-VL2MF cannot be installed after wiring.
3. With the XW9Z-VL2MF installed, crimping terminals cannot be used. Use solid wires.
4. Make sure that the XW9Z-VL2MF is securely installed. IP20 cannot be achieved when installed loosely, and electric shocks may occur.

Be sure to install an insulating tube on the crimping terminal.

2. Tighten the M3 terminal screw to a tightening torque of 0.6 to 1.0 N·m.

Connector Type

1. Connector shape  
Tyco Electronics, D-2000 series  
Part No. 1376009-1 (tab header, board mount)
2. Applicable connectors (to be supplied by user)  
Tyco Electronics, D-2000 series  
Part No. 1-1318119-4 (receptacle housing)  
Tyco Electronics, D-2000 series  
Part No. 1318107-1 (receptacle contact)
3. To prepare correct receptacles for the connector type, read the instruction sheet and catalog of Tyco Electronics and understand the installation and wiring method.
4. Fasten the cable so that the connector is not pulled.  
Otherwise the switch may be deformed and damaged, causing malfunction or operation failure.

Installing and Removing Terminal Covers

XW9Z-VL2M

To install the terminal cover, align the TOP marking on the terminal cover with the TOP marking on the contact block. Place the two projections on the bottom side of the contact block into the slots in the terminal cover. Press the terminal cover toward the contact block.

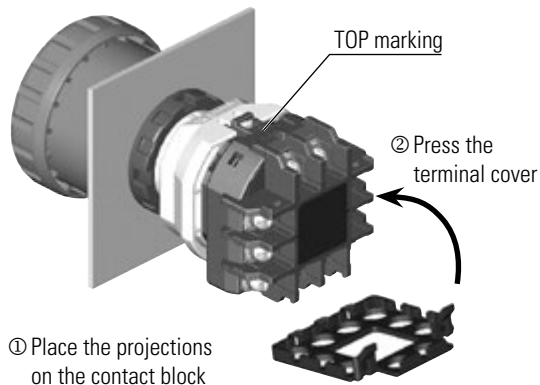

Contact Bounce

When the button is reset by pulling or turning, the NC main contacts will bounce. When pressing the button, the NO monitor contacts will bounce.

When designing a control circuit, take the contact bounce time into consideration (reference value: 20 ms).

LED Illuminated Switches

An LED lamp is built into the contact block and cannot be replaced.

Installing the Anti-rotation Ring HW9Z-RL

Align the side without thread on the operator with TOP marking, the small s marking on the anti-rotation ring, and the recess on the mounting panel.

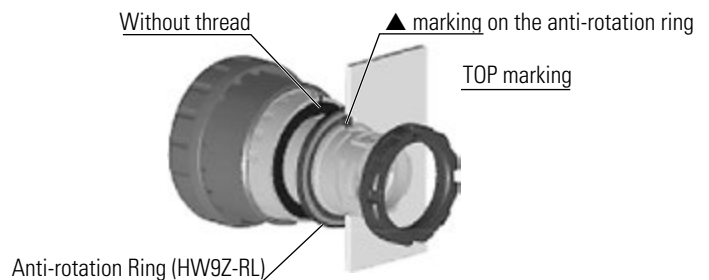

**TWTD Series – Full Size NEMA Pushbuttons**



**TWTD Series: Heavy duty switches built to last**

**Key features:**

- Variety of button sizes up to 2 9/16" (65mm)
- Rugged construction includes chrome plated zinc locking ring die cast zinc mounting threads, screw mounted contact blocks
- LED or incandescent illumination
- Transformer or full voltage
- Transparent contact windows
- Slow make, double break self-cleaning contacts
- Modular construction for maximum flexibility
- Double nickel plated terminal screws
- Available assembled or as sub-components
- Type 4x and IP65 watertight/oiltight panel
- Large M3.5 screw terminals with captive sems plate

The rugged series of TWTD switches offers both variety and durability in an attractive design.

With button sizes up to 2 9/16" (65mm), chrome plated zinc locking rings, die cast zinc mounting threads, steel anti-rotation rings, and self cleaning contacts, the TWTDs are here to stay.

The TWTD series also offers either LED or incandescent illumination in full voltage and transformer models.

Transparent contact windows allow the viewing of IDEC's self cleaning slow-make/slow-break contacts.

Regardless of your switching needs, the TWTD series provides the kind of long lasting, industrial strength quality you've come to expect from IDEC.



Switches & Pilot Devices

Signaling Lights

Relays & Sockets

Timers

Contactors

Terminal Blocks

Circuit Breakers

**Specifications**

Conforming to Standards	EN60947-1, EN60947-5-1, VDE0660-200, UL508, CSA C22-2 No.14
Approvals	<b>CSA:</b> pushbuttons and selector switches: A600 pilot lights and illuminated pushbuttons, direct supply pilot lights and illuminated pushbuttons with integral transformer (100/110, 115, 120, 200/220, 230, 240, 380, 400/440, 480V) <b>UL:</b> pushbuttons and selector switches: A600 pilot lights and illuminated pushbuttons, direct supply pilot lights and illuminated pushbuttons with integral transformer (100/110, 115, 120, 200/220, 230, 240, 380, 400/440, 480V) <b>TÜV:</b> pushbuttons and selector switches: A600–P600 (NO, NC)/Q600 (NO-EM, NC-LB) pilot lights and illuminated pushbuttons, direct supply pilot lights and illuminated pushbuttons with integral transformer (100/110, 115, 120, 200/220, 230, 240, 380, 400/440, 480V)
Operating Temperature	Operation: –25 to +50°C (without freezing) Storage: –40 to +70°C (without freezing)
Vibration Resistance	10 to 55Hz, 98m/sec <sup>2</sup> (10g) conforming to IEC6068-2-6
Shock Resistance	980m/sec <sup>2</sup> (100g) conforming to IEC6068-2-7
Electric Shock Protection	Class 0 conforming to IEC60536
Degree of Protection	IP65 (from front of the panel) (conforming to IEC60529) IP54 (key switches) Type 1, 2, 3, 3R, 3S, 4, 4X, 5, 12, 13 (conforming to NEMA ICS6-110)
Mechanical Life	Momentary pushbuttons: 5,000,000 (900 operations per hour) All other switches: 500,000
Pollution Degree (conforming to IEC60947-1)	3 for switches not using a transformer 2 for switches using a transformer

**Mechanical-Electrical Specifications**

Rated Operational Characteristics	AC-15: A600 or Ue = 250V, Ie = 3A (NO, NC, NO-EM, NC-LB) DC-13: P600 or Ue = 125V, Ie = 1.1A (NO, NC) DC-13: Q600 or Ue = 125V, Ie = 0.9A (NO-EM, NC-LB)
Rated Insulation Voltage	600V
Rated Switching Overvoltage	Less than 4kV, conforming to IEC60947-1
Rated Impulse Withstanding Voltage	4kV for contact circuit 2.5kV for lamp circuit
Rated Thermal Current	10 Amp
Minimum Switching Capacity	5 mA at 3V AC/DC
Contact Operation	Slow break NC or NO, self-cleaning
Operating Force	Flush and extended pushbuttons—with 1NO or 1NC contact: 6.2±2N (momentary), 7.0±2N (maintained) Additional contacts—1NO or 1NC: +3.2N (momentary), + 3.3N (maintained)
Terminal Referencing	Conforming to CENELEC EN50005
Recommended Terminal Torque	0.8 N m (7.1 in lb.)
External Short-Circuit Protection	10A 250V fuse conforming to IEC60269-1
Applicable Wire Size	Minimum 1 x 22 AWG, max. 2 x 14 AWG or 1 x 12 AWG
Contact Resistance	Initial contact resistance of 50mΩ or less
Contact Gap	4mm (NO and NC) 2mm (NO-EM and NC-LB)
Lamp Ratings	Incandescent: 1 W LEDs: 6V: 17mA, 12V: 11mA, 24V: 11mA, / 120, 240V: 10mA
Maximum Inrush Current	40 A (40 msec)
Contact Material	Silver

**Contact Ratings**

Contact Ratings by Utilization Category IEC 60947-5-1		AC-15 (A600)	
		DC-13 (P600)	
Contact Ratings by Utilization Category			
Operational Voltage		24V    48V    50V    110V    220V    440V	
Operation Current	AC 50/60 Hz	AC-12 Control of resistive loads & solid state loads	10A    —    10A    10A    6A    2A
		AC-15 Control of electromagnetic loads (> 72VA)	10A    —    7A    5A    3A    1A
	DC	DC-12 Control of resistive loads & solid state loads	8A    5A    —    2.2A    1.1A    —
		DC-13 Control of electromagnets	5A    2A    —    1.1A    0.6A    —

Non-Illuminated Pushbuttons (Assembled)

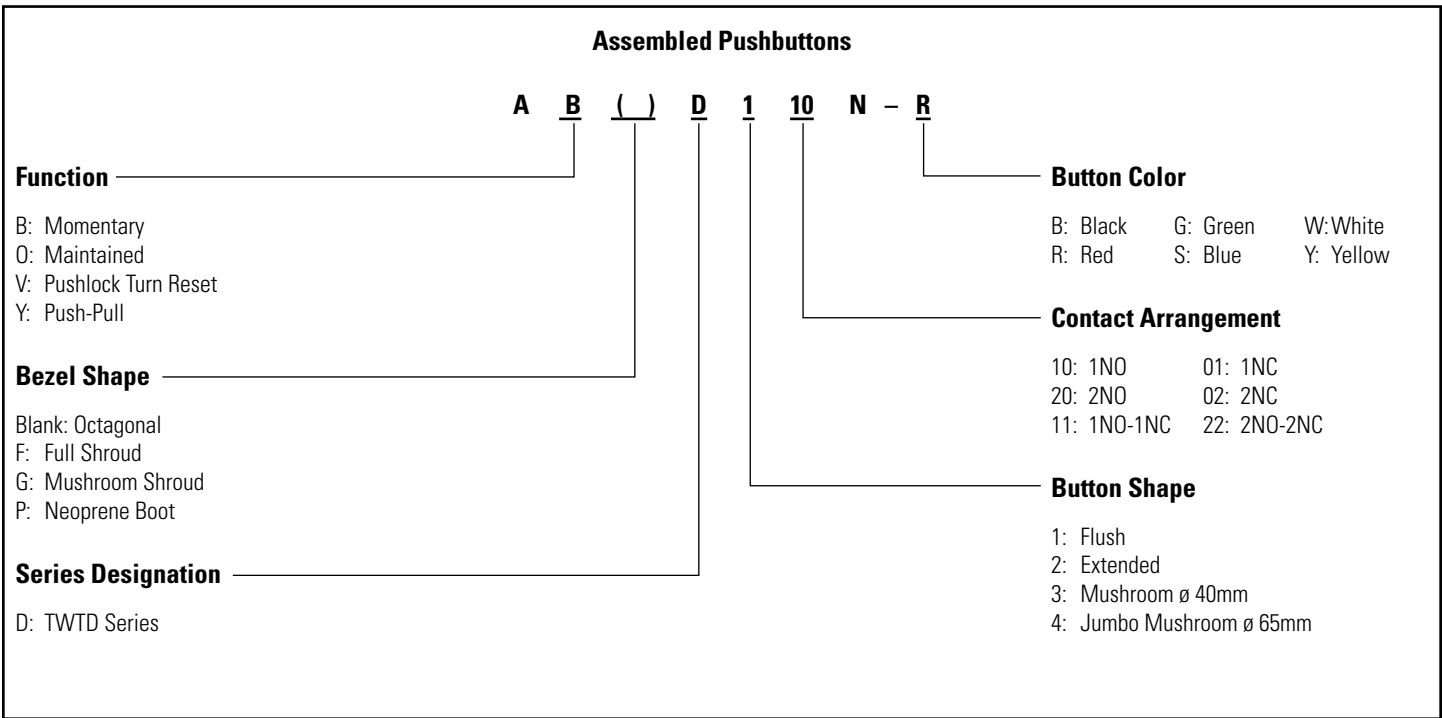

1. Use only when interpreting part numbers. Do not use for developing part numbers.  
2. Custom contact configurations available, contact IDEC for details.



Non-Illuminated Pushbuttons (Assembled)

Non-Illuminated Pushbuttons

Style	Contacts	Momentary	Maintained
Flush	1NO	ABD110N-Ⓞ	AOD110N-Ⓞ
	1NC	ABD101N-Ⓞ	AOD101N-Ⓞ
	1NO-1NC	ABD111N-Ⓞ	AOD111N-Ⓞ
	2NO	ABD120N-Ⓞ	AOD120N-Ⓞ
	2NC	ABD102N-Ⓞ	AOD102N-Ⓞ
Extended	1NO	ABD210N-Ⓞ	AOD210N-Ⓞ
	1NC	ABD201N-Ⓞ	AOD201N-Ⓞ
	1NO-1NC	ABD211N-Ⓞ	AOD211N-Ⓞ
	2NO	ABD220N-Ⓞ	AOD220N-Ⓞ
	2NC	ABD202N-Ⓞ	AOD202N-Ⓞ
Extended with Neoprene Boot*	1NO	ABPD210N-Ⓞ	AOPD210N-Ⓞ
	1NC	ABPD201N-Ⓞ	AOPD201N-Ⓞ
	1NO-1NC	ABPD211N-Ⓞ	AOPD211N-Ⓞ
	2NO	ABPD220N-Ⓞ	AOPD220N-Ⓞ
	2NC	ABPD202N-Ⓞ	AOPD202N-Ⓞ
Recessed	1NO	ABFD110N-Ⓞ	AOFD110N-Ⓞ
	1NC	ABFD101N-Ⓞ	AOFD101N-Ⓞ
	1NO-1NC	ABFD111N-Ⓞ	AOFD111N-Ⓞ
	2NO	ABFD120N-Ⓞ	AOFD120N-Ⓞ
	2NC	ABFD102N-Ⓞ	AOFD102N-Ⓞ
Extended with Full Shroud	1NO	ABFD210N-Ⓞ	AOFD210N-Ⓞ
	1NC	ABFD201N-Ⓞ	AOFD201N-Ⓞ
	1NO-1NC	ABFD211N-Ⓞ	AOFD211N-Ⓞ
	2NO	ABFD220N-Ⓞ	AOFD220N-Ⓞ
	2NC	ABFD202N-Ⓞ	AOFD202N-Ⓞ
ø 40mm Mushroom Head	1NO	ABD310N-Ⓞ	AOD310N-Ⓞ
	1NC	ABD301N-Ⓞ	AOD301N-Ⓞ
	1NO-1NC	ABD311N-Ⓞ	AOD311N-Ⓞ
	2NO	ABD320N-Ⓞ	AOD320N-Ⓞ
	2NC	ABD302N-Ⓞ	AOD302N-Ⓞ
ø 40mm Mushroom Head with Full Shroud	1NO	ABGD310N-Ⓞ	AOGD310N-Ⓞ
	1NC	ABGD301N-Ⓞ	AOGD301N-Ⓞ
	1NO-1NC	ABGD311N-Ⓞ	AOGD311N-Ⓞ
	2NO	ABGD320N-Ⓞ	AOGD320N-Ⓞ
	2NC	ABGD302N-Ⓞ	AOGD302N-Ⓞ
ø 65mm Jumbo Mushroom Head	1NO	ABD410N-Ⓞ	AOD410N-Ⓞ
	1NC	ABD401N-Ⓞ	AOD401N-Ⓞ
	1NO-1NC	ABD411N-Ⓞ	AOD411N-Ⓞ
	2NO	ABD420N-Ⓞ	AOD420N-Ⓞ
	2NC	ABD402N-Ⓞ	AOD402N-Ⓞ
ø 65mm Jumbo Mushroom Head with Shallow Shroud	1NO	ABGD410N-Ⓞ	AOGD410N-Ⓞ
	1NC	ABGD401N-Ⓞ	AOGD401N-Ⓞ
	1NO-1NC	ABGD411N-Ⓞ	AOGD411N-Ⓞ
	2NO	ABGD420N-Ⓞ	AOGD420N-Ⓞ
	2NC	ABGD402N-Ⓞ	AOGD402N-Ⓞ
ø 65mm Jumbo Mushroom Head With Deep Shroud	1NO	ABFD410N-Ⓞ	AOFD410N-Ⓞ
	1NC	ABFD401N-Ⓞ	AOFD401N-Ⓞ
	1NO-1NC	ABFD411N-Ⓞ	AOFD411N-Ⓞ
	2NO	ABFD420N-Ⓞ	AOFD420N-Ⓞ
	2NC	ABFD402N-Ⓞ	AOFD402N-Ⓞ

Ⓞ Button Color Codes

Color	Code
Black	B
Green	G
Red	R
Blue	S
Yellow	Y
White	W

- 1. 65mm Jumbo mushroom not available in white.
- 2. Neoprene boot is not available in blue or white.

- 1. In place of Ⓞ, specify the Button Color Code.
- 2. For sub-assembly part numbers, see next page.
- 3. For accessories, see page 732.
- 4. \*Neoprene boot available only in Black (B), Green (G), Red (R) and Yellow (Y).

Non-Illuminated Pushbuttons (Sub-Assembled)

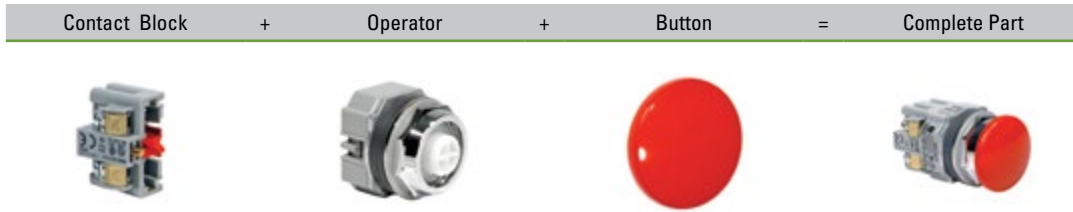

Operators

Style	Image	Part Number	
		Momentary	Maintained
Flush/Extended		ABD-100	AOD-100
Extended with Full Shroud		ABFD-200	AOFD-200
ø 40mm Mushroom/ø 65mm Jumbo Mushroom		ABD-300	AOD-300
ø 40mm Mushroom with Full Shroud		ABGD-300	AOGD-300
ø 65mm Jumbo Mushroom with Shallow Shroud		ABGD-400	AOGD-400
ø 65mm Jumbo Mushroom with Deep Shroud		ABFD-400	AOFD-400

Buttons and Lenses

Style	Image	Part Number
Flush		ABD1BN-⓪
Extended		ABD2BN-⓪
ø 40mm Mushroom		ABD3BN-⓪
ø 65mm Jumbo Mushroom		ABD4BN-⓪

In place of ⓪, specify the Button Color Code. (See table previous page)

Contact Blocks

Style	Image	Part Number	
		1NO	1NC
All Control Units		BST-010	BST-001
		BST-010S (early make)	BST-001S (late break)
Dummy Block		BST-D	

- 1. Dummy blocks (no contacts) are used with an odd number of contact blocks.
- 2. Combining BST-010S and BST-001S result in overlapping contacts (remain on, or closed, when switch is moved between two positions).



Stop Switches (Assembled)



**Assembled Stop Switches**

**A V (L) D 3 (99) 11 (D) N - R - (24V)**

<p><b>Function</b></p> <p>V: Pushlock Turn Reset Y: Push-Pull</p> <p><b>Illumination</b></p> <p>Blank: None L: Illuminated</p> <p><b>Series Designation</b></p> <p>D: TWTD Series</p> <p><b>Button/Lens Size</b></p> <p>3: 40mm Mushroom</p> <p><b>Illumination Circuit</b></p> <p>99: Full Voltage (lamp determines voltage) 126: 120V AC Step Down Transformer 246: 240V AC Step Down Transformer 486: 480V AC Step Down Transformer</p>	<p><b>Lamp Voltage</b> (full voltage illuminated units only)</p> <p>6V: 6V AC/DC 12V: 12V AC/DC 24V: 24V AC/DC 120V: 120V AC (LED only) 240V: 240V AC (LED only)</p> <p><b>Button/Lens Color Code</b></p> <p>A: Amber G: Green R: Red S: Blue W: White Y: Yellow</p> <p><b>Lamp Type</b> (illuminated units only)</p> <p>Blank: Incandescent D: LED</p> <p><b>Contact Arrangement</b></p> <table border="0"> <tr> <td>10: 1NO</td> <td>01: 1NC</td> </tr> <tr> <td>20: 2NO</td> <td>02: 2NC</td> </tr> <tr> <td>11: 1NO-1NC</td> <td>22: 2NO-2NC</td> </tr> </table>	10: 1NO	01: 1NC	20: 2NO	02: 2NC	11: 1NO-1NC	22: 2NO-2NC
10: 1NO	01: 1NC						
20: 2NO	02: 2NC						
11: 1NO-1NC	22: 2NO-2NC						

1. Use only when interpreting part numbers. Do not use for developing part numbers.  
2. Custom contact configurations available, contact IDEC for details.

### Stop Switches (Assembled)

#### Stop Switches

Style	Contacts	Part Number	
ø 40mm Pushlock Turn Reset 	1NO	AVD310N-R*	
	1NC	AVD301N-R*	
	1NO-1NC	AVD311N-R*	
	2NO	AVD320N-R*	
	2NC	AVD302N-R*	
ø 40mm Illuminated Pushlock Turn Reset 	1NO-1NC	AVLD39911ⓈN-R-Ⓢ*	
	2NO	AVLD39920ⓈN-R-Ⓢ*	
	2NC	AVLD39902ⓈN-R-Ⓢ*	
ø 40mm Push-Pull 	1NO	AYD310N-Ⓢ	
	1NC	AYD301N-Ⓢ	
	1NO-1NC	AYD311N-Ⓢ	
ø 40mm Push-Pull 	2NO	AYD320N-Ⓢ	
	2NC	AYD302N-Ⓢ	
	Full Voltage	1NO-1NC	AYLD39911ⓈN-Ⓢ-Ⓢ**
		2NO	AYLD39920ⓈN-Ⓢ-Ⓢ**
		2NC	AYLD39902ⓈN-Ⓢ-Ⓢ**
Transformer	1NO-1NC	AYLD3Ⓢ 11ⓈN-Ⓢ**	
	2NO	AYLD3Ⓢ 20ⓈN-Ⓢ**	
	2NC	AYLD3Ⓢ 02ⓈN-Ⓢ**	
ø 40mm Momentary Push-Pull (3-position) 	Full Voltage	1NO-1NC	AYLD229911ⓈN-Ⓢ-Ⓢ -TK962
		1NC-1LB†	AYLD229902SⓈN-Ⓢ-Ⓢ-TK962
	Transformer	1NO-1NC	AYLD22Ⓢ 11ⓈN-Ⓢ-TK962
		1NC-1LB†	AYLD22Ⓢ 02SⓈN-Ⓢ-TK962

#### Unibody E-Stops

Style	Contacts	Part Number
ø 40mm Pushlock Turn Reset (available in Red only) 	1NO-1NC 2NC	HN1E-BV4F11-R* HN1E-BV4F02-R*
Illuminated ø 40mm Pushlock Turn Reset (available in Red only) 	1NO-1NC 2NC	HN1E-LV4F11QⓈ-R-Ⓢ HN1E-LV4F02QⓈ-R-Ⓢ

#### 3 Position Push-Pull†

Contact	Push	Center	Pull
NC (BST-001)	0	0	X
NC-LB (BST-001S)	0	X	X
NO (BST-010)	X	0	0
NO-EM (BST-010S)	X	X	0

#### ① Button Color Codes

Color	Code
Black	B
Green	G
Red	R
Blue	S
Yellow	Y

#### ② LED/Lens Color Codes

Color	Code
Amber	A
Green	G
Red	R
Blue	S
White	W

#### ③ Full Voltage Codes

Voltage	Code
6V AC/DC	6V
12V AC/DC	12V
24V AC/DC	24V
120V AC	120V
240V AC	240V (LED only)

#### ④ Transformer Voltage Codes

Voltage	Code
120VAC	126
240VAC	246
480VAC	486



Transformers step down to 6V.

#### ⑤ Lamp Type Codes

Lamp	Code
Incandescent	Blank
LED	D



- In place of ①, specify the button color code
- In place of ②, specify the lens color code.
- In place of ③, specify the Full Voltage (lamp voltage) Code.
- In place of ④, specify the transformer voltage code.
- In place of ⑤, specify the Lamp Type code.
- With single unit construction, the positive action contacts are integrated in the body of the switch. This provides an extra degree of safety and reliability for critical emergency stop functions.
- HN1E series E-stops comply with the IEC "E-Stop Addendum to the Low Voltage Directive," this includes "tamper proof" operation whereby a change of contact state is not possible by "teasing" or "floating" the operator.
- 3 position push-pull available in spring return to center only.
- \*Available in red only.
- \*\*Not available in blue.
- †The most common configuration for motor starting applications.
- ‡For sub-assembly part numbers, see next page.
- ‡For nameplates and accessories, see page 734 and page 732.
- ‡For dimensions, see page 737.

### Stop Switches (Sub-Assembled)

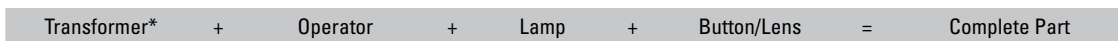





\* Not required for full voltage units (full voltage clips used instead).

#### Operators



Style	Part Number
 ø40mm Pushlock Turn Reset	AVD-300
 Illuminated ø40mm Pushlock Turn Reset	AVLD3-0600N
 ø40mm Push-Pull	AYD-3100
 Illuminated ø 40mm Push-Pull	2 pos AYLD-0600
	3 pos AYLD22TK962-0B01

#### Buttons and Lenses

Style	Part Number
 Button for Pushlock Turn Reset Stop Switches (ø40mm, red only)	AVN3B-R
 Lens for Illuminated Pushlock Turn Reset Stop Switches (ø40mm, red only)	AVLN3LU-R
 Button for Push-Pull Stop Switches (ø40mm)	AYD3BN-①
 Lens for Illuminated Push-Pull Stop Switches (ø40mm)	2 pos* AYLD3L-②
	3 pos AYLD2L-②

- In place of ①, specify the Button Color Code. (See table below)
- In place of ②, specify the LED Color Code.
- \*Not available in blue.

#### Lamps

Style	Voltage	Part Number
 LED	6V AC/DC	LSTD-6②
	12V AC/DC	LSTD-1②
	24V AC/DC	LSTD-2②
	120V AC	LSTD-H2②
	240V AC	LSTD-M4②
 Incandescent	6V AC/DC	IS-6
	12V AC/DC	IS-12
	24V AC/DC	IS-24
	120V AC	L-120L

- In place of ②, specify the LED color code.
- The LED contains a current-limiting resistor and a protection diode.

#### ① Button Color Codes

Color	Code
Black	B
Green	G
Red	R
Blue	S
Yellow	Y

#### ② LED Color Codes

Color	Code
Amber	A
Green	G
Red	R
Blue	S
White	W

#### Contact Blocks

Style	Part Number	
	1NO	1NC
 All Control Units	BST-010	BST-001
	BST-010S (early make)	BST-001S (late break)
Dummy Block	BST-D	

- Dummy blocks (no contacts) are used with an odd number of contact blocks.
- Combining BST-010S and BST-001S result in overlapping contacts.

#### Full Voltage Clips

Primary Voltage (50/60Hz)	Part Number
 Full Voltage Clips (2 required for each unit)	APD-F

#### Transformers

Style	Primary Voltage (50/60Hz)	Part Number
	120V AC	TWD-0126
	240V AC	TWD-0246
	480V AC	TWD-0486

6V secondary voltage (uses 6V lamp).



Pilot Lights (Assembled)



**Assembled Pilot Lights**

**A P D 1 126 D N - R - ( )**

**Function** \_\_\_\_\_  
P: Pilot Light

**Series Designation** \_\_\_\_\_  
D: TWTD Series

**Lens Shape** \_\_\_\_\_  
1: Dome

**Rated Operational Voltage (Primary)**  
Transformer Type Full Voltage Type  
126: 120V AC 99: Full Voltage  
246: 240V AC  
486: 480V AC



**Lamp Voltage**  
(full voltage illuminated units only)  
6V: 6V AC/DC  
12V: 12V AC/DC  
24V: 24V AC/DC  
120V: 120V AC (LED only)  
240V: 240V AC (LED only)

**Lens Color Code**  
A: Amber  
G: Green  
R: Red  
S: Blue  
W: White  
Y: Yellow

**Lamp Type**  
Blank: Incandescent  
D: LED

Use only when interpreting part numbers. Do not use for developing part numbers.

**LED and Incandescent Pilot Lights**

Style	Operating Voltage	Part Number	
		LED	Incandescent
 Transformer Dome	120V AC 240V AC 480V AC	APD1126DN-②	APD1126N-②
		APD1246DN-②	APD1246N-②
		APD1486DN-②	APD1486N-②
 Full Voltage Dome	—	APD199DN-②-③	APD199N-②-③

**② Lens Color Codes**

Color	Code
Amber	A
Green	G
Red	R
Blue	S
White	W
Yellow	Y

**③ Full Voltage Codes**

Voltage	Code
6V AC/DC	6V
12V AC/DC	12V
24V AC/DC	24V
120V AC	120V
240V AC	240V (LED only)

- 1. In place of ②, specify the Lens/LED Color Code.
- 2. In place of ③, specify the Full Voltage Code (lamp voltage).
- 3. Yellow pilot light comes with white LED.

Pilot Lights (Sub-Assembled)



\* Not required for full voltage units (full voltage clips used instead).



Operators

Style	Part Number
	APD-006
	APD-199



Full voltage operator comes with full voltage clips.

Lenses

Style	Part Number
	APN106LN-②

1. In place of ②, specify the Lens Color Code.  
2. LED and incandescent lenses differ in shade only. Some colors have only one shade.

Lamps

Style	Voltage	Part Number
	6V AC/DC	LSTD-6②
	12V AC/DC	LSTD-1②
	24V AC/DC	LSTD-2②
	120V AC	LSTD-H2②
	240V AC	LSTD-M4②
	6V AC/DC	IS-6
	12V AC/DC	IS-12
	24V AC/DC	IS-24
	120V AC	L-120L

1. In place of ②, specify the LED color code.  
2. The LED contains a current-limiting resistor and a protection diode.

Full Voltage Clips

Primary Voltage (50/60Hz)	Part Number
	APD-F

Required for all full voltage models. Two pieces each.

Transformers

Style	Primary Voltage (50/60Hz)	Part Number
	120V AC	TWD-0126
	240V AC	TWD-0246
	480V AC	TWD-0486

6V secondary voltage (use 6V lamp).

② LED/Lens Color Codes

Color	Code
Amber	A
Green	G
Red	R
Blue	S
White	W
Yellow	Y

Yellow lens only. Yellow LED not available, use white LED.

**Illuminated Pushbuttons (Assembled)**



**Assembled Illuminated Pushbuttons**

**A L ( ) D 2 126 11 (D) N - R - ( )**

**Function**

L: Momentary Action  
OL: Maintained Action

**Bezel Shape**

Blank: Octagonal  
F: Full Shroud

**Series Designation**

D: TWTD Series

**Lens Shape**

2: Extended  
3: Mushroom ø 40mm

**Rated Operational Voltage (Primary)**

Transformer Type	Full Voltage Type
126: 120V AC	99: Full Voltage
246: 240V AC	
486: 480V AC	

**Lamp Voltage**  
(full voltage only)

6V: 6V AC/DC  
12V: 12V AC/DC  
24V: 24V AC/DC  
120V: 120V AC  
240V: 240V AC (LED only)

**Lens Color Code**

A: Amber  
G: Green  
R: Red  
S: Blue  
W: White  
Y: Yellow

**Lamp Type**

Blank: Incandescent  
D: LED

**Contact Arrangement**

20: 2NO      02: 2NC  
11: 1NO-1NC

1. Use only when interpreting part numbers. Do not use for developing part numbers.  
2. All transformers step down to 6V.



**Illuminated Pushbuttons (Assembled)**

**Illuminated Pushbuttons**

Style	Contacts	Part Number		
		Momentary	Maintained	
Extended Lens 	Full Voltage	1NO-1NC 2NO 2NC	ALD29911ⓈN-②-③ ALD29920ⓈN-②-③ ALD29902ⓈN-②-③	AOLD29911ⓈN-②-③ AOLD29920ⓈN-②-③ AOLD29902ⓈN-②-③
	Transformer	1NO-1NC 2NO 2NC	ALD2 ④ 11ⓈN-② ALD2 ④ 20ⓈN-② ALD2 ④ 02ⓈN-②	AOLD2 ④ 11ⓈN-② AOLD2 ④ 20ⓈN-② AOLD2 ④ 02ⓈN-②
Extended Lens with Full Shroud 	Full Voltage	1NO-1NC 2NO 2NC	ALFD29911ⓈN-②-③ ALFD29920ⓈN-②-③ ALFD29902ⓈN-②-③	AOLFD29911ⓈN-②-③ AOLFD29920ⓈN-②-③ AOLFD29902ⓈN-②-③
	Transformer	1NO-1NC 2NO 2NC	ALFD2 ④ 11ⓈN-② ALFD2 ④ 20ⓈN-② ALFD2 ④ 02ⓈN-②	AOLFD2 ④ 11ⓈN-② AOLFD2 ④ 20ⓈN-② AOLFD2 ④ 02ⓈN-②
ø 40mm Mushroom Lens 	Full Voltage	1NO-1NC 2NO 2NC	ALD39911ⓈN-②-③ ALD39920ⓈN-②-③ ALD39902ⓈN-②-③	AOLD39911ⓈN-②-③ AOLD39920ⓈN-②-③ AOLD39902ⓈN-②-③
	Transformer	1NO-1NC 2NO 2NC	ALD3 ④ 11ⓈN-② ALD3 ④ 20ⓈN-② ALD3 ④ 02ⓈN-②	AOLD3 ④ 11ⓈN-② AOLD3 ④ 20ⓈN-② AOLD3 ④ 02ⓈN-②

**② Lens Color Codes**

Color	Code
Amber	A
Green	G
Red	R
Blue	S
White	W
Yellow	Y

**③ Full Voltage Codes**

Voltage	Code
6V AC/DC	6V
12V AC/DC	12V
24V AC/DC	24V
120V AC	120V
240V AC	240V (LED only)

**④ Transformer Voltage Codes**

Voltage	Code
120VAC	126
240VAC	246
480VAC	486

 6V secondary voltage (uses 6V lamp).

**⑤ Lamp Type Codes**

Lamp	Code
Incandescent	Blank
LED	D

- 1. In place of ②, specify the Lens Color Code.
- 2. In place of ③, specify the Full Voltage Code (lamp voltage).
- 3. In place of ④, specify the Transformer Voltage Code.
- 4. In place of ⑤, specify the Lamp Type Code.
- 5. Light is independent of switch position.
- 6. Yellow pushbutton comes with white LED only.



### Illuminated Pushbuttons (Sub-Assembled)

Transformer\* + Contact Block + Operator + Lamp + Lens = Complete Part



\*Not required for full voltage types (full voltage types use APD-F full voltage clips).

#### Operators

Style	Part Number	
	Momentary	Maintained
Extended	ALD-0600	AOLD-0600
Extended with Full Shroud	ALFD-0600	AOLFD-0600
40mm Mushroom	ALD-0600	AOLD-0600

#### Lamps

Style	Voltage	Part Number
LED	6V AC/DC	LSTD-6Ⓞ
	12V AC/DC	LSTD-1Ⓞ
	24V AC/DC	LSTD-2Ⓞ
	120V AC	LSTD-H2Ⓞ
	240V AC	LSTD-M4Ⓞ
Incandescent	6V AC/DC	IS-6
	12V AC/DC	IS-12
	24V AC/DC	IS-24
	120V AC	L-120L

#### LED/Lens Color Codes

Color	Code
Amber	A
Green	G
Red	R
Blue	S
White	W
Yellow	Y

Yellow lens only. Yellow LED not available, use white LED.

- 1. In place of Ⓞ, specify the LED color code.
- 2. The LED contains a current-limiting resistor and a protection diode.

#### Contact Blocks

Style	Part Number	
	1NO	1NC
All Control Units	BST-010	BST-001
	BST-010S (early make)	BST-001S (late break)
Dummy Block	BST-D	

- 1. Dummy blocks (no contacts) are used with an odd number of contact blocks.
- 2. Combining BST-010S and BST-001S result in overlapping contacts (remain on, or closed, when switch is moved between two positions).

#### Transformers

Style	Primary Voltage (50/60Hz)	Part Number
Transformers	120V AC	TWD-0126
	240V AC	TWD-0246
	480V AC	TWD-0486

6V secondary voltage (use 6V lamp).

#### Lenses

Style	Part Number
Extended	ALN06LU-Ⓞ
ø 40mm Mushroom	ALN3LU-Ⓞ

In place of Ⓞ, specify the Lens Color Code.

#### Full Voltage Clips

Style	Part Number
Full Voltage Clips (2 required for each unit)	APD-F

Required for all full voltage models.

Non-Illuminated Selector Switches (Assembled)



Assembled Selector Switches

**A S D 2 ( ) ( ) 11 N - ( )**

**Function**

S: Selector Switch

**Series Designation**

D: TWTD Series

**Number of Positions**

2: 2-Position  
3: 3-Position

**Spring Return Action**

Blank: Maintained  
1: Spring return from Right  
2: Spring return from Left  
3: 2-Way spring return from Left and Right

**Circuit Number**

(See Circuit # column of Selector Switch Contact Arrangement Chart on beginning on page 729.)

**Contact Arrangement Code**

10: 1NO    01: 1NC  
20: 2NO    02: 2NC  
40: 4NO    04: 4NC  
11: 1NO-1NC    22: 2NO-2NC

**Operator Style Code**

Blank: Knob Operator  
L: Lever Operator  
K: Key Operator

- 1. Use only when interpreting part numbers. Do not use for developing part numbers.
- 2. Custom key removal codes available. Please contact IDEC for details.

Non-Illuminated Selector Switches (Assembled)

Non-Illuminated 2-Position Selector Switches

Style					Part Number		
Contact	Mounting	Operator Position			Maintained	Spring Return from Right	Spring Return from Left
		L	R				
1NO	1 2	0 0	X 0	Knob Lever Key	ASD210N ASD2L10N ASD2K10N	ASD2110N ASD21L10N ASD21K10N	ASD2210N ASD22L10N ASD22K10N
1NC	1 2	X 0	0 0	Knob Lever Key	ASD201N-116 ASD2L01N-116 ASD2K01N-116	ASD2101N-116 ASD21L01N-116 ASD21K01N-116	ASD2201N-116 ASD22L01N-116 ASD22K01N-116
1NO 1NC	1 2	0 X	X 0	Knob Lever Key	ASD211N ASD2L11N ASD2K11N	ASD2111N ASD21L11N ASD21K11N	ASD2211N ASD22L11N ASD22K11N
2NO	1 2	0 0	X X	Knob Lever Key	ASD220N ASD2L20N ASD2K20N	ASD2120N ASD21L20N ASD21K20N	ASD2220N ASD22L20N ASD22K20N
2NC	1 2	X X	0 0	Knob Lever Key	ASD202N-104 ASD2L02N-104 ASD2K02N-104	ASD2102N-104 ASD21L02N-104 ASD21K02N-104	ASD2202N-104 ASD22L02N-104 ASD22K02N-104
2NO 2NC	1 2 3 4	0 X 0 X	X 0 X 0	Knob Lever Key	ASD222N ASD2L22N ASD2K22N	ASD2122N ASD21L22N ASD21K22N	ASD2222N ASD22L22N ASD22K22N
2NO 2NC	1 2 3 4	0 0 X X	X X 0 0	Knob Lever Key	ASD222N-111 ASD2L22N-111 ASD2K22N-111	ASD2122N-111 ASD21L22N-111 ASD21K22N-111	ASD2222N-111 ASD22L22N-111 ASD22K22N-111



- The truth table indicates the operating position of contact block when the operator is switched to that position.  
X = On (closed contacts) 0 = Off (open contacts)  
X-X = Overlapping Contacts: Remain on (closed contacts) when switch is moved between these two positions.
- All knob and lever selector switches come in black. Other colors are available by ordering the knob or lever separately.
- Custom contact arrangements available, see page 729.

Non-Illuminated 3-Position Selector Switches

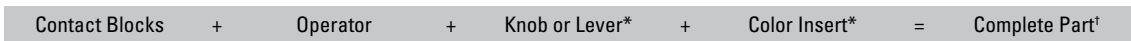

Style						Part Number			
Contact	Mounting	Operator Position				Maintained	Spring Return from Right	Spring Return from Left	Spring Return Two-Way
		L	C	R					
2NO	1 2	X 0	0 0	0 X	Knob Lever Key	ASD320N ASD3L20N ASD3K20N	ASD3120N ASD31L20N ASD31K20N	ASD3220N ASD32L20N ASD32K20N	ASD3320N ASD33L20N ASD33K20N
2NC	1 2	0 X	X X	X 0	Knob Lever Key	ASD302N ASD3L02N ASD3K02N	ASD3102N ASD31L02N ASD31K02N	ASD3202N ASD32L02N ASD32K02N	ASD3302N ASD33L02N ASD33K02N
2NO 2NC	1 2 3 4	X 0 0 X	0 0 X X	0 X X 0	Knob Lever Key	ASD322N ASD3L22N ASD3K22N	ASD3122N ASD31L22N ASD31K22N	ASD3222N ASD32L22N ASD32K22N	ASD3322N ASD33L22N ASD33K22N
2NO 2NC	1 2 3 4	X X 0 0	0 X X 0	X 0 0 X	Knob Lever Key	ASD322N-309 ASD3L22N-309 ASD3K22N-309	ASD3122N-309 ASD31L22N-309 ASD31K22N-309	ASD3222N-309 ASD32L22N-309 ASD32K22N-309	ASD3322N-309 ASD33L22N-309 ASD33K22N-309
2NO 2NC	1 2 3 4	0 0 0 0	X 0 X 0	0 X 0 X	Knob Lever Key	ASD322N-310 ASD3L22N-310 ASD3K22N-310	ASD3122N-310 ASD31L22N-310 ASD31K22N-310	ASD3222N-310 ASD32L22N-310 ASD32K22N-310	ASD3322N-310 ASD33L22N-310 ASD33K22N-310
4NO	1 2 3 4	X 0 X 0	0 0 0 0	0 X 0 X	Knob Lever Key	ASD340N ASD3L40N ASD3K40N	ASD3140N ASD31L40N ASD31K40N	ASD3240N ASD32L40N ASD32K40N	ASD3340N ASD33L40N ASD33K40N
4NC	1 2 3 4	0 X 0 X	X X X X	X 0 X 0	Knob Lever Key	ASD304N ASD3L04N ASD3K04N	ASD3104N ASD31L04N ASD31K04N	ASD3204N ASD32L04N ASD32K04N	ASD3304N ASD33L04N ASD33K04N

### Non-Illuminated Selector Switches (Sub-Assembled)



- 1. \*Not needed with key type switches.
- 2. †Knob type shown.

#### Operators

Style	Position	Description	Part Number	
Knob/Lever 	2	Maintained	ASD200	
		Spring return from right	ASD2100	
		Spring return from left	ASD2200	
	3	Maintained, Cam 1 Maintained, Cam 2	ASD300-1	ASD300-2
			Spring return from right, Cam 1 Spring return from right, Cam 2	ASD3100-1 ASD3100-2
		Spring return from left, Cam 1 Spring return from left, Cam 2	ASD3200-1	ASD3200-2
Spring return from left/right, Cam 1 Spring return from left/right, Cam 2			ASD3300-1 ASD3300-2	
Key 		2	Maintained	ASD2K00-RA
			Spring return from right	ASD21K00-RL
	Spring return from left		ASD22K00	
	3	Maintained, Cam 1 Maintained, Cam 2	ASD3K00-1	ASD3K00-2
			Spring return from right, Cam 1 Spring return from right, Cam 2	ASD31K00-1-RLC ASD31K00-2-RLC
		Spring return from left, Cam 1 Spring return from left, Cam 2	ASD32K00-1-RRC ASD32K00-2-RRC	
Spring return from left/right, Cam 1 Spring return from left/right, Cam 2	ASD33K00-1-RC ASD33K00-2-RC			

- 1. Order knobs, levers, color inserts separately (see below).
- 2. For key switches, keys are removable in all maintained positions. Other options available, contact IDEC for details.
- 3. See page 731 "Operator Truth Tables" for details of difference between cams.

#### ① Color Codes

Knob/Lever Color	Code
Black	B
Blue	S
Green	G
Red	R
Yellow	Y
White	W

- 1. Knob/Lever not available in white.
- 2. Color inserts not available in Black.
- 3. Lever not available in yellow.

#### Handles and Inserts

Style	Part Number
Knob 	ASDHHY-①
Lever 	ASDHHL-①*
Color Insert 	TW-HC1-①

- 1. In place of ①, specify the Color Code.  
\*Not available in yellow.

#### Contact Blocks

Style	Part Number	
	1NO	1NC
All Control Units 	BST-010 BST-010S (early make)	BST-001 BST-001S (late break)
Dummy Block	BST-D	

- 1. Dummy blocks (no contacts) are used with an odd number of contact blocks.
- 2. Combining BST-010S and BST-001S result in overlapping contacts (remain on, or closed, when switch is moved between two positions).

**Illuminated Selector Switches (Assembled)**



**Assembled Illuminated Selector Switches**

**A SL D 2 (2) 99 11 D N - 111 - R - 24**

**Function**

SL: Illuminated Selector Switch

**Series Designation**

D: TWTD series

**Number of Positions**

2: 2-Position  
3: 3-Position

**Spring Return Action**

Blank: Maintained  
1: Spring return from Right  
2: Spring return from Left  
3: Two-Way spring return from Left and Right

**Rated Operational Voltage (Primary)**

Transformer Type	Full Voltage Type
126: 120V AC	99: Full Voltage
246: 240V AC	
486: 480V AC	

**Contact Arrangement Code**

20: 2NO	02: 2NC
40: 4NO	04: 4NC
11: 1NO-1NC	22: 2NO-2NC

**Lamp Voltage**

(Full Voltage Units Only)

6V: 6V AC/DC  
12V: 12V AC/DC  
24V: 24V AC/DC  
120V: 120V AC  
240V: 240V AC (LED only)

**Lens Color Code**

A: Amber  
G: Green  
R: Red  
S: Blue  
W: White  
Y: Yellow

**Circuit Code Number**

See Circuit # column of Selector Switch Contact Arrangement Charts on page 729.

**Lamp Type**

Blank: Incandescent Lamp  
D: LED Lamp



Use only when interpreting part numbers. Do not use for developing part numbers.

Illuminated Selector Switches (Assembled)

Illuminated 2-Position Selector Switches

Style					Part Number		
Contact	Mounting	Operator Position		Lamp Circuit Type	Maintained	Spring Return from Right	Spring Return from Left
		L	R				
1NO 1NC	1 2	0 X	X 0	Transformer Full Voltage	ASLD2 ④11ⓈN-② ASLD29911ⓈN-②-③	ASLD21 ④11ⓈN-② ASLD219911ⓈN-②-③	ASLD22 ④11ⓈN-② ASLD229911ⓈN-②-③
2NO	1 2	0 0	X X	Transformer Full Voltage	ASLD2 ④20ⓈN-② ASLD29920ⓈN-②-③	ASLD21 ④20ⓈN-② ASLD219920ⓈN-②-③	ASLD22 ④20ⓈN-② ASLD229920ⓈN-②-③
2NC	1 2	X X	0 0	Transformer Full Voltage	ASLD2 ④02ⓈN-104-② ASLD29902ⓈN-104-②-③	ASLD21 ④02ⓈN-104-② ASLD219902ⓈN-104-②-③	ASLD22 ④02ⓈN-104-② ASLD229902ⓈN-104-②-③
2NO 2NC	1 2 3 4	0 X 0 X	X 0 X 0	Transformer Full Voltage	ASLD2 ④22ⓈN-② ASLD29922ⓈN-②-③	ASLD21 ④22ⓈN-② ASLD219922ⓈN-②-③	ASLD22 ④22ⓈN-② ASLD229922ⓈN-②-③
2NO 2NC	1 2 3 4	0 0 X X	X 0 0 0	Transformer Full Voltage	ASLD2 ④22ⓈN-111-② ASLD29922ⓈN-111-②-③	ASLD21 ④22ⓈN-111-② ASLD219922ⓈN-111-②-③	ASLD22 ④22ⓈN-111-② ASLD229922ⓈN-111-②-③

② LED/Lens Color Codes

Color	Code
Amber	A
Green	G
Red	R
Blue	S
White	W
Yellow	Y

③ Full Voltage Codes

Voltage	Code
6V AC/DC	6V
12V AC/DC	12V
24V AC/DC	24V
120V AC	120V
240V AC	240V (LED only)

Illuminated 3-Position Selector Switches, Maintained and Spring Return

Style					Part Number				
Contact	Mounting	Operator Position			Lamp Circuit Type	Maintained	Spring Return From Right	Spring Return from Left	Spring Return Two-Way
		L	C	R					
2NO	1 2	X 0	0 0	0 X	Transformer Full Voltage	ASLD3 ④ 20ⓈN-② ASLD39920ⓈN-②-③	ASLD31 ④ 20ⓈN-② ASLD319920ⓈN-②-③	ASLD32 ④ 20ⓈN-② ASLD329920ⓈN-②-③	ASLD33 ④ 20ⓈN-② ASLD339920ⓈN-②-③
2NC	1 2	0 X	X X	X 0	Transformer Full Voltage	ASLD3 ④ 02ⓈN-② ASLD39902ⓈN-②-③	ASLD31 ④ 02ⓈN-② ASLD319902ⓈN-②-③	ASLD32 ④ 02ⓈN-② ASLD329902ⓈN-②-③	ASLD33 ④ 02ⓈN-② ASLD339902ⓈN-②-③
2NO 2NC	1 2 3 4	X 0 0 X	0 0 X X	0 X X 0	Transformer Full Voltage	ASLD3 ④ 22ⓈN-② ASLD39922ⓈN-②-③	ASLD31 ④ 22ⓈN-② ASLD319922ⓈN-②-③	ASLD32 ④ 22ⓈN-② ASLD329922ⓈN-②-③	ASLD33 ④ 22ⓈN-② ASLD339922ⓈN-②-③
2NO 2NC	1 2 3 4	X X 0 0	0 X X 0	X 0 0 X	Transformer Full Voltage	ASLD3 ④ 22ⓈN-309-② ASLD39922ⓈN-309-②-③	ASLD31 ④ 22ⓈN-309-② ASLD319922ⓈN-309-②-③	ASLD32 ④ 22ⓈN-309-② ASLD329922ⓈN-309-②-③	ASLD33 ④ 22ⓈN-309-② ASLD339922ⓈN-309-②-③
2NO 2NC	1 2 3 4	0 0 0 0	X 0 X 0	0 X 0 X	Transformer Full Voltage	ASLD3 ④ 22ⓈN-310-② ASLD39922ⓈN-310-②-③	ASLD31 ④ 22ⓈN-310-② ASLD319922ⓈN-310-②-③	ASLD32 ④ 22ⓈN-310-② ASLD329922ⓈN-310-②-③	ASLD33 ④ 22ⓈN-310-② ASLD339922ⓈN-310-②-③
4NO	1 2 3 4	X 0 X 0	0 0 0 0	0 X 0 X	Transformer Full Voltage	ASLD3 ④ 40ⓈN-② ASLD39940ⓈN-②-③	ASLD31 ④ 40ⓈN-② ASLD319940ⓈN-②-③	ASLD32 ④ 40ⓈN-② ASLD329940ⓈN-②-③	ASLD33 ④ 40ⓈN-② ASLD339940ⓈN-②-③
4NC	1 2 3 4	0 X 0 X	X X X X	X 0 X 0	Transformer Full Voltage	ASLD3 ④ 04ⓈN-② ASLD39904ⓈN-②-③	ASLD31 ④ 04ⓈN-② ASLD319904ⓈN-②-③	ASLD32 ④ 04ⓈN-② ASLD329904ⓈN-②-③	ASLD33 ④ 04ⓈN-② ASLD339904ⓈN-②-③

- In place of ②, specify the Lens/LED Color Code, in place of ③, specify the Full Voltage (lamp voltage) Code, in place of ④, specify the Transformer Voltage Code and in place of ⑤ specify the Lamp Type Code.
- The truth table indicates the operating position of contact block when the operator is switched to that position.  
X = On (Closed Contacts) 0 = Off (Open Contacts)  
X—X = Overlapping Contacts: Remain on (closed contacts) when switch is moved between these positions
- Yellow selector switch comes with white LED.

④ Transformer Voltage Codes

Voltage	Code
120VAC	126
240VAC	246
480VAC	486

Transformers step down to 6V (use 6V lamp).

⑤ Lamp Type Codes

Lamp	Code
Incandescent	Blank
LED	D

Light is independent of switch position.



### Illuminated Selector Switches (Sub-Assembled)



\*Not required for full voltage units (use APD-F full voltage clips instead).

#### Operators

Style	Position	Description	Part Number
Operator	2	Maintained	ASLD200
	3	Maintained, Cam 1	ASLD300-1
		Maintained, Cam 2	ASLD300-2
	2	Spring return from right	ASLD2100
		Spring return from left	ASLD2200
	3	Spring return from right, Cam 1	ASLD3100-1
		Spring return from right, Cam 2	ASLD3100-2
		Spring return from left, Cam 1	ASLD3200-1
Spring return from left, Cam 2		ASLD3200-2	
3	Spring return from left/right, Cam 1	ASLD3300-1	
	Spring return from left/right, Cam 2	ASLD3300-2	

#### Contact Blocks

Style	Part Number	
	1NO	1NC
All Control Units	BST-010	BST-001
	BST-010S (early make)	BST-001S (late break)
Dummy Block	BST-D	



- Dummy blocks (no contacts) are used with an odd number of contact blocks.
- Combining BST-010S and BST-001S result in overlapping contacts (remain on, or closed, when switch is moved between two positions).

#### Full Voltage Clips

Style	Part Number
Full Voltage Clips (2 required for each unit)	APD-F



Required for all full voltage models.

#### Transformers

Style	Primary Voltage (50/60Hz)	Part Number
Transformers	120V AC	TWD-0126
	240V AC	TWD-0246
	480V AC	TWD-0486



6V secondary voltage.

#### LED/Lens Color Codes

Color	Code	Color	Code
Amber	A	Blue	S
Green	G	White	W
Red	R	Yellow	Y



Yellow lens only. Yellow LED not available, use white LED.

#### Lenses

Style	Part Number
Knob	ASLNHU-①

#### Lamps

Style	Voltage	Part Number
LED	6V AC/DC	LSTD-6②
	12V AC/DC	LSTD-1②
	24V AC/DC	LSTD-2②
	120V AC	LSTD-H2②
	240V AC	LSTD-M4②
Incandescent	6V AC/DC	IS-6
	12V AC/DC	IS-12
	24V AC/DC	IS-24
	120V AC	L-120L



- In place of ②, specify the LED color code.
- The LED contains a current-limiting resistor and a protection diode.



Contact Arrangement Charts

How to Read Contact Arrangement Charts

To determine contact block mounting position, first make sure the selector switch is oriented as shown on the right

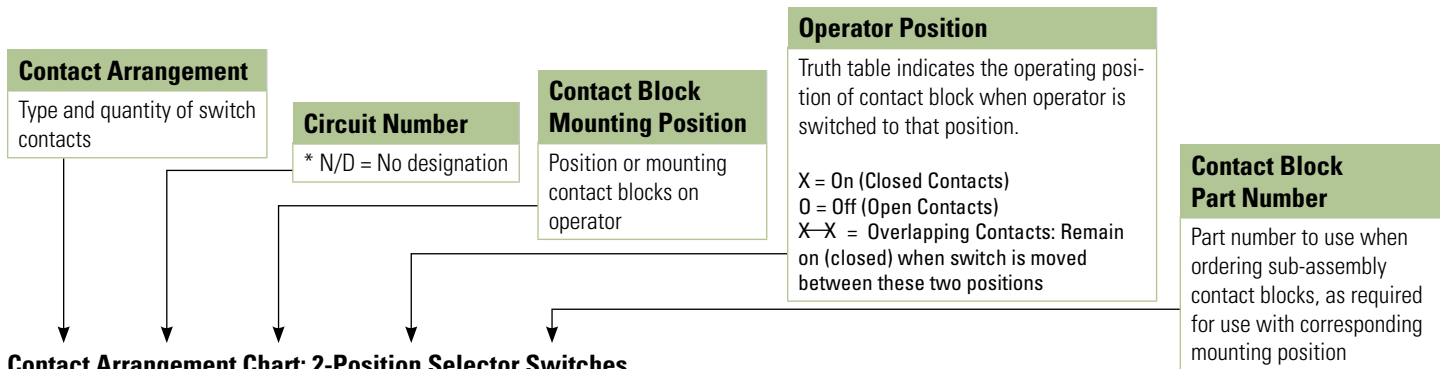

Contact Arrangement Chart: 2-Position Selector Switches

Style		Mounting Position	Operator Position		Contact Block Part Number	Description	Operator Part Number		
Contact	Circuit Number		L	R			Maintained	Spring Return from Right	Spring Return from Left
1NO	N/D	1	O	X	BST-010	Knob/Lever Key	ASD200 ASD2K00	ASD2100 ASD21K00	ASD2200 ASD22K00
		2	O	O	BST-D	Illuminated Knob	ASLD200	ASLD2100	ASLD2200
1NC	116	1	X	O	BST-001	Knob/Lever Key	ASD200 ASD2K00	ASD2100 ASD21K00	ASD2200 ASD22K00
		2	O	O	BST-D	Illuminated Knob	ASLD200	ASLD2100	ASLD2200
1NO 1NC	N/D	1	O	X	BST-010	Knob/Lever Key	ASD200 ASD2K00	ASD2100 ASD21K00	ASD2200 ASD22K00
		2	X	O	BST-001	Illuminated Knob	ASLD200	ASLD2100	ASLD2200
	103	1	X	O	BST-001	Knob/Lever Key	ASD200 ASD2K00	ASD2100 ASD21K00	ASD2200 ASD22K00
		2	O	X	BST-010	Illuminated Knob	ASLD200	ASLD2100	ASLD2200
1NO-EM 1NC-LB	600	1	O	X	BST-010S	Knob/Lever Key	ASD200 ASD2K00	ASD2100 ASD21K00	ASD2200 ASD22K00
		2	X	O	BST-001S	Illuminated Knob	ASLD200	ASLD2100	ASLD2200
	601	1	X	O	BST-001S	Knob/Lever Key	ASD200 ASD2K00	ASD2100 ASD21K00	ASD2200 ASD22K00
		2	O	X	BST-010S	Illuminated Knob	ASLD200	ASLD2100	ASLD2200
2NO	N/D	1	O	X	BST-010	Knob/Lever Key	ASD200 ASD2K00	ASD2100 ASD21K00	ASD2200 ASD22K00
		2	O	X	BST-010	Illuminated Knob	ASLD200	ASLD2100	ASLD2200
2NC	104	1	X	O	BST-001	Knob/Lever Key	ASD200 ASD2K00	ASD2100 ASD21K00	ASD2200 ASD22K00
		2	X	O	BST-001	Illuminated Knob	ASLD200	ASLD2100	ASLD2200
2NO 2NC	N/D	1	O	X	BST-010	Knob/Lever Key	ASD200	ASD2100	ASD2200
		2	X	O	BST-001	Illuminated Knob	ASLD200	ASLD2100	ASLD2200
		3	O	X	BST-010	Knob/Lever Key	ASD200	ASD2100	ASD2200
		4	X	O	BST-001	Illuminated Knob	ASLD200	ASLD2100	ASLD2200
	110	1	X	O	BST-001	Knob/Lever Key	ASD200	ASD2100	ASD2200
		2	O	X	BST-010	Illuminated Knob	ASD2K00	ASD21K00	ASD22K00
		3	X	O	BST-001	Knob/Lever Key	ASD200	ASD2100	ASD2200
		4	O	X	BST-010	Illuminated Knob	ASLD200	ASLD2100	ASLD2200
111	1	O	X	BST-010	Knob/Lever Key	ASD200	ASD2100	ASD2200	
	2	O	X	BST-010	Knob/Lever Key	ASD2K00	ASD21K00	ASD22K00	
	3	X	O	BST-001	Illuminated Knob	ASLD200	ASLD2100	ASLD2200	
	4	X	O	BST-001	Illuminated Knob	ASLD200	ASLD2100	ASLD2200	
4NO	N/D	1	O	X	BST-010	Knob/Lever Key	ASD200	ASD2100	ASD2200
		2	O	X	BST-010	Knob/Lever Key	ASD2K00	ASD21K00	ASD22K00
		3	O	X	BST-010	Knob/Lever Key	ASD200	ASD2100	ASD2200
		4	O	X	BST-010	Illuminated Knob	ASLD200	ASLD2100	ASLD2200

Switches & Pilot Devices

Signaling Lights

Relays & Sockets

Timers

Contactors

Terminal Blocks

Circuit Breakers

Contact Arrangement Chart: 3-Position Selector Switches

Contact	Circuit Number	Mounting Position	Operator Position			Contact Block Part Number	Description	Operator Part Number				
			L	C	R			Maintained	Spring Return from Right	Spring Return from Left	Two-Way	
1NO 1NC	202	1	X	0	0	BST-010	Knob/Lever Key	ASD300-1 ASD3K00-1 ASLD300-1	ASD3100-1 ASD31K00-1 ASLD3100-1	ASD3200-1 ASD32K00-1 ASLD3200-1	ASD3300-1 ASD33K00-1 ASLD3300-1	
		2	X	X	0	BST-001	Illuminated Knob					
	203	1	0	X	X	BST-001	Knob/Lever Key	ASD300-1 ASD3K00-1 ASLD300-1	ASD3100-1 ASD31K00-1 ASLD3100-1	ASD3200-1 ASD32K00-1 ASLD3200-1	ASD3300-1 ASD33K00-1 ASLD3300-1	
		2	0	0	X	BST-010	Illuminated Knob					
	302	1	X	0	X	BST-010	Knob/Lever Key	ASD300-2 ASD3K00-2 ASLD300-2	ASD3100-2 ASD31K00-2 ASLD3100-2	ASD3200-2 ASD32K00-2 ASLD3200-2	ASD3300-2 ASD33K00-2 ASLD3300-2	
		2	X	X	0	BST-001	Illuminated Knob					
	303	1	0	X	0	BST-001	Knob/Lever Key	ASD300-2 ASD3K00-2 ASLD300-2	ASD3100-2 ASD31K00-2 ASLD3100-2	ASD3200-2 ASD32K00-2 ASLD3200-2	ASD3300-2 ASD33K00-2 ASLD3300-2	
		2	0	0	X	BST-010	Illuminated Knob					
	2NO	N/D	1	X	0	0	BST-010	Knob/Lever Key	ASD300-1 ASD3K00-1 ASLD300-1	ASD3100-1 ASD31K00-1 ASLD3100-1	ASD3200-1 ASD32K00-1 ASLD3200-1	ASD3300-1 ASD33K00-1 ASLD3300-1
			2	0	0	X	BST-010	Illuminated Knob				
301		1	X	0	X	BST-010	Knob/Lever Key	ASD300-2 ASD3K00-2 ASLD300-2	ASD3100-2 ASD31K00-2 ASLD3100-2	ASD3200-2 ASD32K00-2 ASLD3200-2	ASD3300-2 ASD33K00-2 ASLD3300-2	
		2	0	0	X	BST-010	Illuminated Knob					
2NC	304	1	0	X	0	BST-001	Knob/Lever Key	ASD300-2 ASD3K00-2 ASLD300-2	ASD3100-2 ASD31K00-2 ASLD3100-2	ASD3200-2 ASD32K00-2 ASLD3200-2	ASD3300-2 ASD33K00-2 ASLD3300-2	
		2	X	X	0	BST-001	Illuminated Knob					
	N/D	1	0	X	X	BST-001	Knob/Lever Key	ASD300-1 ASD3K00-1 ASLD300-1	ASD3100-1 ASD31K00-1 ASLD3100-1	ASD3200-1 ASD32K00-1 ASLD3200-1	ASD3300-1 ASD33K00-1 ASLD3300-1	
		2	X	X	0	BST-001	Illuminated Knob					
2NO 2NC	N/D	1	X	0	0	BST-010	Knob/Lever Key Illuminated Knob	ASD300-1 ASD3K00-1 ASLD300-1	ASD3100-1 ASD31K00-1 ASLD3100-1	ASD3200-1 ASD32K00-1 ASLD3200-1	ASD3300-1 ASD33K00-1 ASLD3300-1	
		2	0	0	X	BST-010						
		3	0	X	X	BST-001						
		4	X	X	0	BST-001						
	210	1	0	X	X	BST-001	Knob/Lever Key Illuminated Knob	ASD300-1 ASD3K00-1 ASLD300-1	ASD3100-1 ASD31K00-1 ASLD3100-1	ASD3200-1 ASD32K00-1 ASLD3200-1	ASD3300-1 ASD33K00-1 ASLD3300-1	
		2	0	0	X	BST-010						
		3	0	X	X	BST-001						
		4	0	0	X	BST-010						
	308	1	X	0	X	BST-010	Knob/Lever Key Illuminated Knob	ASD300-2 ASD3K00-2 ASLD300-2	ASD3100-2 ASD31K00-2 ASLD3100-2	ASD3200-2 ASD32K00-2 ASLD3200-2	ASD3300-2 ASD33K00-2 ASLD3300-2	
		2	X	X	0	BST-001						
		3	X	0	X	BST-010						
		4	X	X	0	BST-001						
309	1	X	0	X	BST-010	Knob/Lever Key Illuminated Knob	ASD300-2 ASD3K00-2 ASLD300-2	ASD3100-2 ASD31K00-2 ASLD3100-2	ASD3200-2 ASD32K00-2 ASLD3200-2	ASD3300-2 ASD33K00-2 ASLD3300-2		
	2	X	X	0	BST-001							
	3	0	X	0	BST-001							
	4	0	0	X	BST-010							
310	1	0	X	0	BST-001	Knob/Lever Key Illuminated Knob	ASD300-2 ASD3K00-2 ASLD300-2	ASD3100-2 ASD31K00-2 ASLD3100-2	ASD3200-2 ASD32K00-2 ASLD3200-2	ASD3300-2 ASD33K00-2 ASLD3300-2		
	2	0	0	X	BST-010							
	3	0	X	0	BST-001							
	4	0	0	X	BST-010							

- Each operator sub-assembly is available as a "-1" and a "-2" for 3-position selector switches. The internal cam of a "-1" is different from that of a "-2". This results in designated combinations of open and closed contacts in the various operator positions.
- N/D = No circuit number designation required in assembled part number.
- X = On (closed contacts) 0 = Off (open contacts). X-X Overlapping contacts remain on (closed) when switch is moved between these two positions.

Contact Arrangement Chart: 3-Position Selector Switches

Style		Mounting Position	Operator Position			Contact Block Part Number	Description	Operator Part Number			
Contact	Circuit Number		L	C	R			Maintained	Spring Return from Right	Spring Return from Left	Two-Way
4NO	N/D	1	X	0	0	BST-010	Knob/Lever Key Illuminated Knob	ASD300-1 ASD3K00-1 ASLD300-1	ASD3100-1 ASD31K00-1 ASLD3100-1	ASD3200-1 ASD32K00-1 ASLD3200-1	ASD3300-1 ASD33K00-1 ASLD3300-1
		2	0	0	X	BST-010					
		3	X	0	0	BST-010					
		4	0	0	X	BST-010					
	305	1	X	0	X	BST-010	Knob/Lever Key Illuminated Knob	ASD300-2 ASD3K00-2 ASLD300-2	ASD3100-2 ASD31K00-2 ASLD3100-2	ASD3200-2 ASD32K00-2 ASLD3200-2	ASD3300-2 ASD33K00-2 ASLD3300-2
		2	0	0	X	BST-010					
		3	X	0	X	BST-010					
		4	0	0	X	BST-010					
4NC	N/D	1	0	X	X	BST-001	Knob/Lever Key Illuminated Knob	ASD300-1 ASD3K00-1 ASLD300-1	ASD3100-1 ASD31K00-1 ASLD3100-1	ASD3200-1 ASD32K00-1 ASLD3200-1	ASD3300-1 ASD33K00-1 ASLD3300-1
		2	X	X	0	BST-001					
		3	0	X	X	BST-001					
		4	X	X	0	BST-001					
	314	1	0	X	0	BST-001	Knob/Lever Key Illuminated Knob	ASD300-2 ASD3K00-2 ASLD300-2	ASD3100-2 ASD31K00-2 ASLD3100-2	ASD3200-2 ASD32K00-2 ASLD3200-2	ASD3300-2 ASD33K00-2 ASLD3300-2
		2	X	X	0	BST-001					
		3	0	X	0	BST-001					
		4	X	X	0	BST-001					

- Each operator sub-assembly is available as a "-1" and a "-2" for 3-position selector switches. The internal cam of a "-1" is different from that of a "-2". This results in designated combinations of open and closed contacts in the various operator positions.
- N/D = No circuit number designation required in assembled part number.
- X = On (closed contacts) 0 = Off (open contacts). X-X Overlapping contacts remain on (closed) when switch is moved between these two positions.

Operator Truth Tables

Use the following tables to build custom selector switches.

2 Position Selector Switches

	Contact	Mounting Position	Operator Position	
			Left	Right
ASD200	BST-010 (NO)	L	0	X
		R	0	X
	BST-001 (NC)	L	X	0
		R	X	0
	BST-010S (NO-EM)	L	0	X-X
		R	0	X-X
	BST-001S (NC-LB)	L	X-X	0
		R	X-X	0

3 Position Selector Switches

	Contact	Mounting Position	Operator Position		
			Left	Center	Right
ASD300-1 ASLD300-1 ASD3K00-1	BST-010 (NO)	L	X	0	0
		R	0	0	X
	BST-001 (NC)	L	0	X-X	X
		R	X-X	X	0
	BST-010S (NO-EM)	L	X	0	0
		R	0	0	X
	BST-001S (NC-LB)	L	0	X-X	X
		R	X	X	0

3 Position Push/Pull Switches

	Contact	Operator Position		
		Pull	Normal	Push
AYLD22	BST-010 (NO)	0	0	X
	BST-001 (NC)	X	0	0
	BST-010S (NO-EM)	0	X	X
	BST-001S (NC-LB)	X	X	0

	Contact	Mounting Position	Operator Position		
			Left	Center	Right
ASD300-2 ASLD300-2 ASD3K00-2	BST-010 (NO)	L	X	0	X
		R	0	0	X
	BST-001 (NC)	L	0	X	0
		R	X-X	X	0
	BST-010S (NO-EM)	L	X	0	X
		R	0	0	X
	BST-001S (NC-LB)	L	0	X	0
		R	X	X	0

Accessories – TWTD Series

TWTD Series Accessories

Item	Appearance	Description/Usage	Part Number	
Lamp Removal Tool		Rubber tool used to install or remove LED's and incandescent lamps	OR-55	
Metal Bezel		Standard octagonal units (chrome-pl.).	OG-81	
		Extended, non-illuminated (chrome-pl.).	OG-82	
		Extended, illuminated (chrome-pl.).	OG-83L	
		Jumbo Mushroom Shallow Shroud	ABN4G	
		Jumbo Mushroom Deep Shroud	ABN4F	
Plastic Bezel		Black plastic locking ring/bezel	OGP11B	
Boot/Cover		Used to cover and protect pushbuttons	In place of ⊕, specify <b>Neoprene Rubber Boot</b> color: <b>B</b> (black), <b>G</b> (green), <b>R</b> (red), <b>Y</b> (yellow)	
			OC-11 ⊕	
			Flush units (clear plastic -40° to +60°C).	OC-121
		Extended units (clear plastic -40° to +60°C).	OC-122	
Anti-Rotation Ring		Plastic washer For nameplates or panels that should not be scratched.	OGL-D1T	
		Thrust washer/Anti-rotation ring for use with notched panel cutout.	OGL-D1S	
Mounting Hole Plug		Plugs used to fill unused 30mm panel cutouts.	Plastic with locking nut attached.	
			OBP-11	
			Metal with locking nut attached	OB-11
			Grey rubber (-5° to +60°C)	OB-13
Terminal Tab Adaptor		Tab #250 17/64" x 3/64" (6.35mm x 0.8mm): Single tab	TW-FA1	
Full Voltage Adaptor		Used on all full voltage illuminated units. Two required per unit. (M3.5 screw and saddle)	APD-F	
Lock Out Adaptor		Used to provide lockout protection for TWTD pushbuttons and knob selectors. ø 1-13/64" (30mm)	OL-KL1	
Replacement Keys		Pair of keys (#0)	TW-SK	

Fingersafe Covers for TWTD Series

Item	Description	Used with	Part Number
	Fingersafe terminal cover, for full voltage pilot lights, adds 3mm to overall depth	APD199... full voltage pilot lights	APD-PVL
	Fingersafe terminal cover, for contact blocks, adds 3mm to overall depth	Non-Illuminated pushbuttons ABD..., and AOD...	N-VL2
	Fingersafe terminal cover, adds 1.5mm to overall depth	Transformer pilot lights and illuminated units	N-VL3
	Fingersafe terminal cover, adds 4 mm to depth	Full voltage illuminated pushbuttons	N-VL4

 Dimensions on page 737.

Switches & Pilot Devices

Signaling Lights

Relays & Sockets

Timers

Contactors

Terminal Blocks

Circuit Breakers

Nameplates – TWTD Series

Faceplates

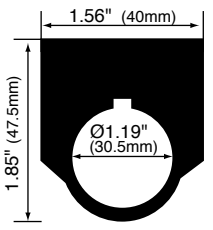
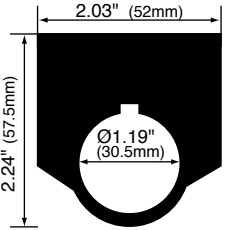
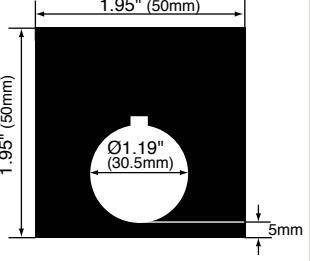
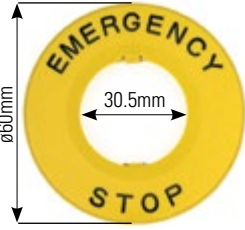
	NALD	NAKD	NAQD	HNAV
Dimensions				
Description	Part Number			
Nameplate (blank)	NALD-B (black) NALD-R (red)	NAKD-B (black) NAKD-R (red)	NAQD-B (black) NAQD-R (red)	HNAV-0
Nameplate (engraved)	NALD-⓪	NAKD-⓪	NAQD-⓪	HNAV-27 "Emergency Stop"

1. Nameplates are made of 0.031" aluminum. Lettering is white letters engraved on black background.
2. In place of ⓪, insert either the standard legend code from table below or custom engraving delimited by " ".
3. HNAV available in yellow only.

Standard Legend Codes

Pushbuttons				Pushbuttons/Selector Switches				Selector Switches	
Legend	Code	Legend	Code	Legend	Code	Legend	Code	Legend	Code
AUTO	101	OPEN	116	AUTO-MAN	201			AUTO-MAN-OFF	301
CLOSE	102	OUT	117	CLOSE-OPEN	202			AUTO-OFF-MAN	302
DOWN	103	RAISE	118	DOWN-UP	203			CLOSE-OFF-OPEN	303
EMERG.STOP*	104	RESET	119	FAST-SLOW	204	REV-FOR	216	DOWN-OFF-SLOW	304
FAST	105	REVERSE	120	FOR-REV	205	RUN-JOG	217	FAST-OFF-SLOW	305
FORWARD	106	RUN	121	HAND-AUTO	206	RUN-SAFE	218	FOR-OFF-REV	306
HAND	107	SLOW	122	HIGH-LOW	207	SAFE-RUN	219	LEFT-OFF-RIGHT	307
HIGH	108	START	123	JOG-RUN	208	SLOW-FAST	220	LOWER-OFF-RAISE	308
IN	109	STOP*	124	LEFT-RIGHT	209	START-STOP	221	OFF-MAN-AUTO	309
INCH	110	STOP	125	LOWER-RAISE	210	STOP-START	222	OFF-SLOW-FAST	310
JOG	111	TEST	126	MAN-AUTO	211	UP-DOWN	223	OFF-1-2	311
LOW	112	UP	127	OFF-ON	212			OPEN-OFF-CLOSE	312
LOWER	113	I (Int'l On)	150	ON-OFF	213			SLOW-OFF-FAST	313
OFF	114	O (Int'l Off)	151	OPEN-CLOSE	214			SUMMER-OFF-WINTER	314
ON	115	EMO	152	RAISE-LOWER	215			UP-OFF-DOWN	315
								1-OFF-2	316
								HAND-OFF-AUTO	317

1. \*Available in Red as standard legend code 104 and 124. To order engraved nameplate and codes, add legend code to nameplate part number. Character height based on the number of characters, space and size of nameplate. Standard character size is 3/16".
2. Nameplates with standard legends are the same list price as blank nameplates. Special engravings, additional cost.

To specify engraving instructions, use the Nameplate order form on next page.

**Custom engraved Nameplates Order Form – TWTD Series**

Copy this order form and use it to specify Letter Height, Custom Engravings, Location of Engraving on Nameplate, and Quantity Desired. To ensure engraving accuracy, fax it to your IDEC representative, or Distributor.

Your Company Name: \_\_\_\_\_

IDEC Rep/Distributor Contact: \_\_\_\_\_

Your Name: \_\_\_\_\_

PO number (if known): \_\_\_\_\_

Telephone: \_\_\_\_\_

IDEC Rep/Distributor Phone: \_\_\_\_\_

Fax & Email: \_\_\_\_\_

IDEC Rep/Distributor Fax & Email: \_\_\_\_\_

**NALD Nameplate**

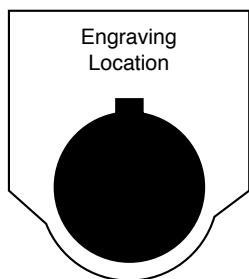

**Step 1.**

Choose Letter Size - 7/64" or 1/8".

Check the box for the letter size you want. Then write your lettering in box below checkboxes. Note: 1/8" size letters cannot exceed 13 characters.

**Sample Letter Sizes**

7/64" Letters: A B C D

1/8" Letters: A B C D

7/64" Letter Size

16 characters max (for 7/64" size letters)

1/8" Letter Size

13 characters max (for 1/8" size letters)

**Step 2.**

Specify Quantity.

Enter the number of nameplates desired in the box on the right.

<b>Qty</b>
------------

-----															
-----															
-----															
-----															
-----															
1	2	3	4	5	6	7	8	9	10	11	12	13	14	15	16

**NAKD Nameplate**

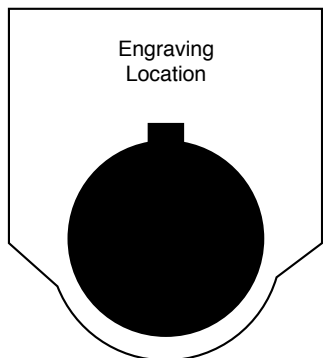

**Step 1.**

Choose Letter Size - 7/64" or 1/8".

Check the box for the letter size you want. Then write your lettering in box below checkboxes. Note: 1/8" size letters cannot exceed 9 characters.

**Step 2.**

Specify Quantity.

Enter the number of nameplates desired in the box on the right.

<b>Qty</b>
------------

-----																
-----																
-----																
-----																
-----																
1	2	3	4	5	6	7	8	9	10	11	12	13	14	15	16	17

**Sample Letter Sizes**

1/8" Letters: A B C D

**NAQD Nameplate**

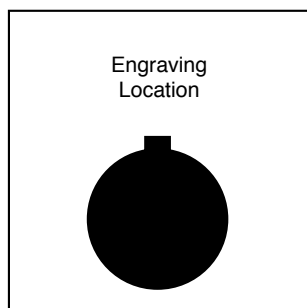

**Step 1.**

Choose Letter Size - 7/64" or 1/8".

Check the box for the letter size you want. Then write your lettering in box below checkboxes. Note: 1/8" size letters cannot exceed 16 characters.

7/64" Letter Size

20 characters max (for 7/64" size letters)

1/8" Letter Size

16 characters max (for 1/8" size letters)

**Step 2.**

Specify Quantity.

Enter the number of nameplates desired in the box on the right.

<b>Qty</b>
------------

-----																			
-----																			
-----																			
-----																			
-----																			
1	2	3	4	5	6	7	8	9	10	11	12	13	14	15	16	17	18	19	20

**Sample Letter Sizes**

3/32" Letters: A B C D

1/8" Letters: A B C D



### Switch Engraving Order Form – TWTD Series

Copy this order form and use it to specify Letter Height, Maximum Number of Lines and Text to be engraved.

To insure engraving accuracy, fax it to your IDEC representative or Distributor.

Your Company: \_\_\_\_\_  
 Name: \_\_\_\_\_  
 Address: \_\_\_\_\_  
 PO: \_\_\_\_\_

Telephone: \_\_\_\_\_  
 Fax: \_\_\_\_\_  
 Email: \_\_\_\_\_  
 Part Number to be Engraved: \_\_\_\_\_

Please check one of the boxes below to indicate your choice of engraving options:



ø29mm, ø40mm Mushroom Head

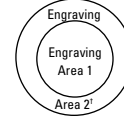

	# of Lines	Letter Height	Max. Characters Per Line
<input type="checkbox"/>	1	5/32	7
<input type="checkbox"/>		1/8	8
<input type="checkbox"/>	2	5/32	7
<input type="checkbox"/>		1/8	8
<input type="checkbox"/>	3	1/8	8
<input type="checkbox"/>	4	Custom*	

\*Engraving is possible, but character size will be smaller than standard sizes.

	# of Lines	Letter Height	Max. Characters Per Line
<input type="checkbox"/>	1	3/4	4
<input type="checkbox"/>		5/16	5
<input type="checkbox"/>	2	5/16	5
<input type="checkbox"/>		1/4	6
<input type="checkbox"/>		5/32	8
<input type="checkbox"/>	3	5/32	8
<input type="checkbox"/>		1/8	9
<input type="checkbox"/>	4	1/8	9

	# of Lines	Letter Height	Max. Characters Per Line	
<input type="checkbox"/>	Engraving Area 1	1	5/32	5
<input type="checkbox"/>		1/8	5	
<input type="checkbox"/>	Engraving Area 2	1	5/32	7
<input type="checkbox"/>		1/8	7	



- Above mentioned specifications hold true for standard size push-buttons (round and square).
- \*Engraving Area 2 can be engraved for 40mm mushroom head non-illuminated pushbutton only.
- Engraving is done on the button itself for non-illuminated push buttons and on marking plate for illuminated push buttons and pilot lights.
- Please enter text exactly how you want it engraved, take care to emphasize capital or small letters.



	# of Lines	Letter Height	Max. Characters Per Line
<input type="checkbox"/>	1	5/32	7
<input type="checkbox"/>		1/8	8
<input type="checkbox"/>	2	5/32	7
<input type="checkbox"/>		1/8	8
<input type="checkbox"/>	3	1/8	8
<input type="checkbox"/>	4	Custom*	

\*Engraving is possible, but character size will be smaller than standard sizes.

Enter text to be engraved:

Line 1: \_\_\_\_\_  
 Line 2: \_\_\_\_\_  
 Line 3: \_\_\_\_\_  
 Line 4: \_\_\_\_\_

#### Sample Letter Sizes

1/8 Letters: **OPEN**

5/32 Letters: **OPEN**



All engraving is 5/8mm wide.

For IDEC Internal Use Only:

Work Order #: \_\_\_\_\_

Dimensions (mm)

Pushbutton

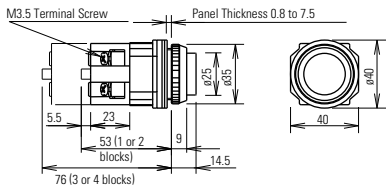

Mushroom Pushbutton w/Full Shroud

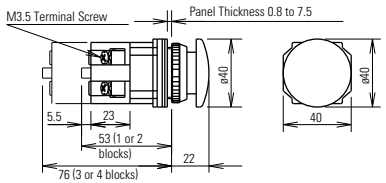

Pushbuttons	Dimension A	Dimension B
Flush	0.351" (9mm)	ø 0.975" (25mm)
Extended	0.566" (14.5mm)	ø 0.975" (25mm)
Extended w/Full Shroud	0.663" (17mm)	ø 1.11" (28.5mm)
Mushroom	0.858" (22mm)	ø 1.56" (40mm)
Mushroom w/Full Shroud	0.936" (24mm)	ø 1.87" (48mm)
Jumbo Mushroom	1.13" (29mm)	ø 2.54" (65mm)
Mushroom, Pushlock Turn Reset and Push-Pull	*0.975" (25mm) **0.975" (25mm)	ø 1.56" (40mm) ø 1.56" (40mm)



\*Dimension when operator is in reset position.  
\*\*Dimension when operator is in pull position.

Illuminated Pushbuttons

w/Transformer

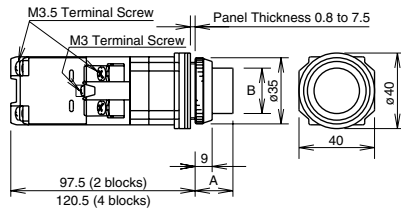

Full Voltage

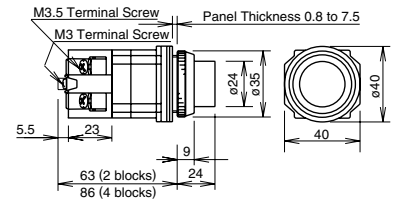

Illuminated Pushbuttons	Dimension A	Dimension B
Flush w/Full Shroud	0.975" (25mm) 0.995" (25.5mm)	ø 0.936" (24mm) ø 0.936" (24mm)
Extended w/Full Shroud	0.741" (19mm) 0.761" (19.5mm)	ø 0.936" (24mm) ø 0.936" (24mm)
ø 1.56" (40mm) Mushroom Pushlock Turn Reset, Push-Pull	*0.975" (25mm) **0.975" (25mm)	ø 1.56" (40mm) ø 1.56" (40mm)

Pilot Lights

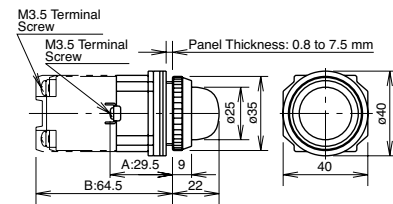

\*Dimension when operator is in reset position.  
\*\*Dimension when operator is in pull position.

Selector Switches

Knob

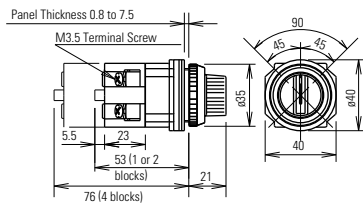

Lever

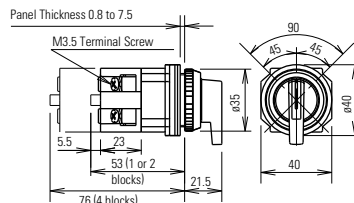

Key

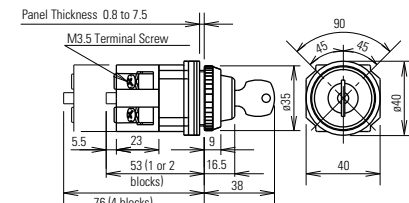

Illuminated Knob

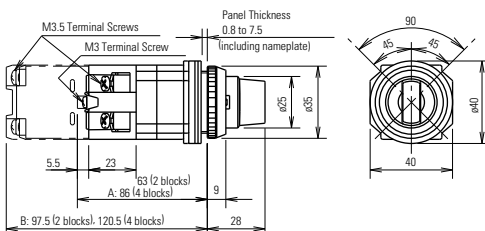

**Selector Switches Panel Cut-Out**

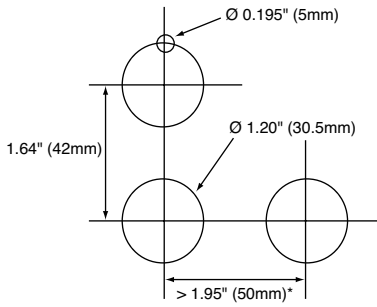

1. \*Jumbo Mushroom < 2.61" (66mm)
2. Minimum mounting centers are applicable to switches with one stack of contact blocks. When mounting two stacks of contact blocks, minimum centers should allow for access to wiring.
3. The ø 0.195" (ø 5mm) recess is necessary when either the nameplate or anti-rotation ring is used.

**Illuminated Selector Switches**

**OL-KL1**

Lock-Out Adaptor

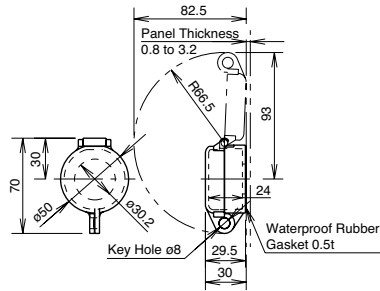

**OC-31**

Pushbutton Clear Boot

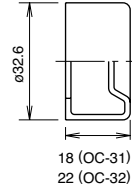

**OGL-31**

Anti-Rotation Ring

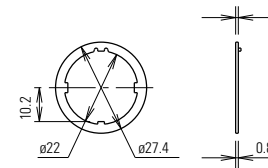

**OB-31**

Mounting Hole Rubber Plug

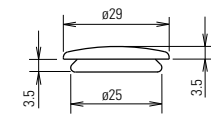

**Finger-Safe Cover**

**N-VL2**

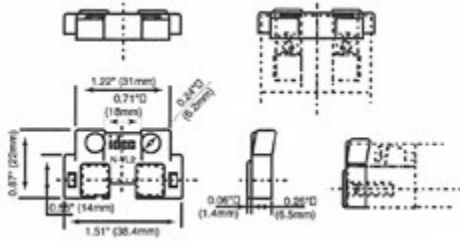

**N-VL3**

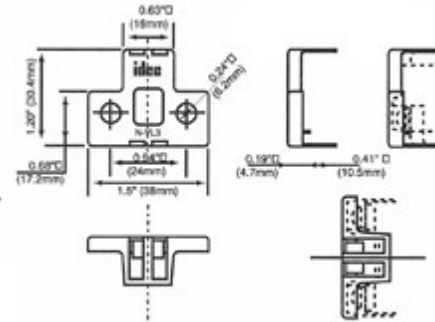

**N-VL4**

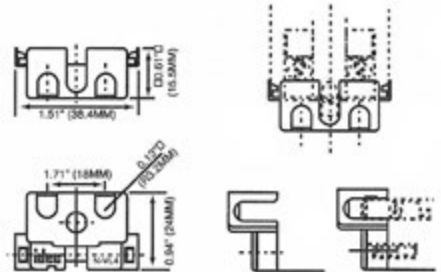

**APD-PVL**

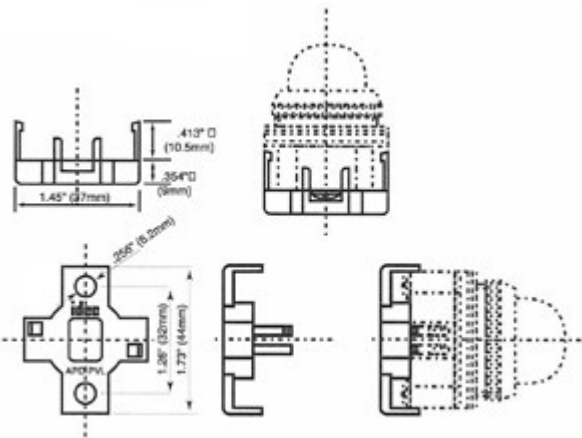

## Operating Instructions

### Adjustment for Panel Thickness

Each unit is shipped with several waterproof gaskets which are 0.06" (1.5mm) and 0.12" (3mm) thick. Combine the gaskets for a dimension approximately equal to panel thickness and install between the bezel and the body of the unit.

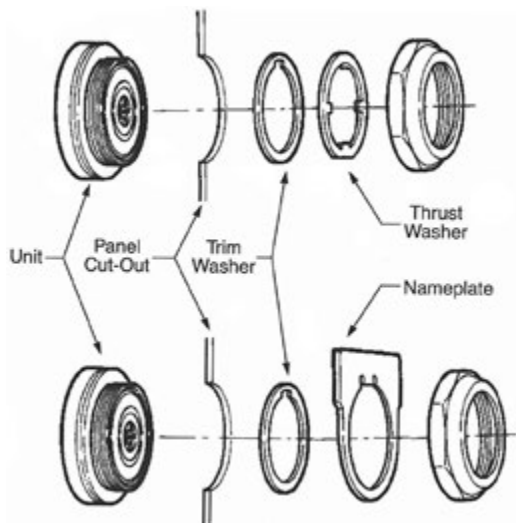

A trim washer must be used with a thrust washer or a nameplate to prevent the control unit from rotating in the mounting hole. When using anti-rotation rings (trim washer with thrust washer or nameplate), install as shown below.

### Selector Switches

The operator shaft of each unit has a recess to identify in which direction to install the handle. Align the handle with the recess. Press color insert (TW-HC1) into the Standard Operating Positions.

#### Standard Operation Positions

2-Position, 90°	3-Position, 45°

#### Non-Illuminated 3-Position Operators

--	--	--

### Installation of TWTD Series Units

#### TWTD Pilot Lights

TWTD Illuminated Pushbuttons  
TWTD Selector Switches  
(Transformer or Full Voltage)

Terminal X1 = Positive  
Terminal X2 = Negative

### Installation of LED Illuminated Units

Transformer units are recommended for use in areas subjected to inductive noise. When using full voltage types, install a protection diode as shown below. Use diode with DC power supply to protect against surges and noise.

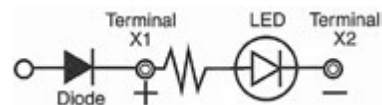

Make sure that LED illuminated units are installed with correct polarity, as indicated at the terminals.

### Application Example For Push-To-Test Pilot Light

A typical application of illuminated pushbuttons is a push-to-test pilot light which can be used to check the lamp/LED circuit.

#### Transformer/AC-Adapter Circuit

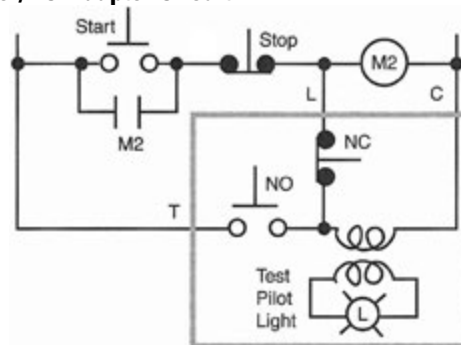

#### Full Voltage Circuit

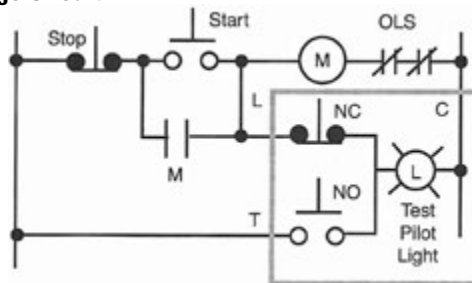

### 30mm Hazardous Location Switches

**Key features:**

- Class I, Zone 1/Division 2
- Applicable in explosive gas atmospheres (AEx de IIC T6 Gb)
- UL Type 4X rated
- Up to 3 contact blocks
- Selector switches available with lever or key
- Selector switches available with overlapping contacts
- Exposed and finger-safe (IP20) screw terminals available



IECEX is pending approval

### Specifications

**Standards Compliance**

	Switches	Pilot Lights	Meters
UL	Class I, Zone 1, AEx de IIC T6 Gb Class I, Div 2, Groups A, B, C and D	Class I, Zone 1, AEx de IIC T6 Gb Class I, Div 2, Groups A, B, C and D	Class I, Zone 1, AEx de IIC T6 Gb Class I, Div 2, Groups A, B, C and D
c-UL	Class I, Zone 1, Ex de IIC T6 Gb Class I, Div 2, Groups A, B, C and D	Class I, Zone 1, Ex de IIB T6 Gb Class I, Div 2, Groups C and D	Class I, Zone 1, Ex de IIC T6 Gb Class I, Div 2, Groups A, B, C and D
ATEX	⚠ IICG Ex de IIC ⚠ IICD tD A21 IP65		⚠ IICG Ex de IIC Gb ⚠ IICD Ex tb IIIC Db IP65

**Certificate Numbers**

UL/cUL	E347230
ATEX	PTB 08 ATEX 1053 U PTB 08 ATEX 1003 U

**Applicable Standards**

Products	Applicable Standards	Mark	Certifications
Pushbuttons Selector Switches Key Selector Switches Pilot Lights	EN60947-5-1	CE	EU Low Voltage Directive
Emergency Stop Switches	EN60947-5-5	TÜV	TÜV SÜD
		CE	EU Low Voltage Directive

General Specifications

Degree of Protection	IP65 (IEC60529), Type 4X	
Insulation Resistance	100 MΩ minimum (500V DC megger)	
Operating Temperature	-20 to +50°C (no freezing)	
Operating Humidity	45 to 85% (no condensation)	
Altitude	2,000m Maximum	
Pollution Degree	3	
Shock Resistance	Operating Extremes	100-m/s <sup>2</sup> Emergency Stop Switch: 150-m/s <sup>2</sup> (without Meter)
	Damage Limits	1000-m/s <sup>2</sup>
Vibration Resistance	Operating Extremes	5 to 55-Hz, amplitude 0.5 mm Emergency Stop Switch: 5 to 500-Hz, amplitude 0.35-mm, acceleration 50-m/s <sup>2</sup> (without Meter)
	Damage Limits	30Hz, amplitude 1.5-mm Emergency Stop Switch: 5 to 500-Hz, amplitude 0.35-mm, acceleration 50-m/s <sup>2</sup>

Switch Specifications

Rated Insulation Voltage	600V	
Contact Resistance	50mΩ maximum (initial value)	
Impulse Withstand Voltage (Uimp)	6kV	
Insulation Resistance	100MΩ minimum (500V DC megger)	
Short-Circuit Protection	250V/10A fuse (Type aM IEC60269-1/IEC60269-2)	
Conditional Short-Circuit Current	1,000A	
Mechanical Life	Pushbutton	1,000,000 operations minimum
	Selector Switch	500,000 operations minimum
	Key Selector Switch	500,000 operations minimum
	Emergency Stop Switch	50,000 operations minimum
Electrical Life	Pushbutton	250,000 (switching frequency 1800 operations/h)
	Selector Switch	250,000 (switching frequency 900 operations/h)
	Key Selector Switch	250,000 (switching frequency 900 operations/h)
	Emergency Stop Switch	50,000 (switching frequency 900 operations/h)
Minimum Operator Stroke Required for Direct Opening Action	Emergency Stop Switch	7.0mm
Maximum Operator Stroke	Emergency Stop Switch	9.0mm

Note: Contacts will bounce during operation of pushbuttons and selector switches (reference value: 20-ms). Be sure to take contact bounce time into consideration when designing a control circuit.

Contact Rating (Switches)

Rated Insulation Voltage (Ui)	600V						
Rated Thermal Current (Ith)	10A*						
Rated Operating Voltage (Ue)	24V	120V	240V	500V			
Rated Operating Current (Ie)	AC 50/60Hz	Resistive Load (AC12)		10A*	10A*	6A	2.8A
		Inductive Load (AC15)		10A*	6A	3A	1.4A
	DC	Resistive Load (DC12)		8A	2.2A	1.1A	—
		Inductive Load (DC13)		4A	1.1A	0.55A	—

Note: Up to 2 contacts (per control unit): 10A  
3 contacts (per control unit): 9A  
Minimum applicable load: 3V AC/DC, 5mA  
Applicable operating locations may vary according to operating conditions and load types.

Contact Rating Code Designation	Thermal Continuous Test Current Amperes	Maximum current, Amperes								Maximum Volt-Amperes	
		120 Volt		240 Volt		480 Volt		600 Volt		600 Volt	
		Make	Break	Make	Break	Make	Break	Make	Break	Make	Break
A600	10	60	6.00	30	3.00	15	1.5	12	1.2	7200	720

Pilot Lights

Rated Insulation Voltage (Ui)	500V	
Rated Operating Voltage (Ue)	Voltage	6V, 12V, 24V AC/DC
	Transformer	120V, 230V, 240V, 380V, 480V AC
Impulse Withstand Voltage (Uimp)	4kV	
Insulation Resistance	100 MΩ minimum (500V DC)	
Frequency	50/60Hz	
Power Consumption (approx.)	Full Voltage	0.3W
	Transformer	1.5VA
Life (reference value)	Approx. 40,000 hours	

Note: Because the built-in LED lamp is a high-brightness version, the lamp may light dimly due to induction even when power is off.

Meters

Accuracy Class	2.5	
Insulation Resistance	100 MΩ minimum (500V DC megger)	
AC ammeter	Rated Insulation Voltage (Ui)	300V
	Operation	Moving core
	Impulse Withstand Voltage (Uimp)	4kV
	Power Consumption	1VA
	Measurement	5A, 10A, 30A, 50A, etc
	Input (CT Ratio)	1A, 5A
Extended Memory	3 times, etc	
DC ammeter	Rated Insulation Voltage (Ui)	150V
	Operation	Moving coil
	Impulse Withstand Voltage (Uimp)	2.5kV
	Input	0 to 10V DC, 4 to 20mA, etc.
	Power Consumption	0.15W
Consumption Current	1mA	

Note: Use a commercially available CT (current transformer) for all AC ammeters, and install the CT in a non-hazardous location.



Pushbuttons



Part Number Structure

EU2B - YB1 11 F S D

**Operator (style / function)**  
 B1 : Flush pushbutton / Momentary  
 B2 : Extended pushbutton / Momentary  
 B3 : Mushroom pushbutton / Momentary

**Contact arrangement**  
 10 : 1NO      01 : 1NC  
 20 : 2NO      02 : 2NC  
 30 : 3NO      03 : 3NC  
 11 : 1NO-1NC    12 : 1NO-2NC  
 21 : 2NO-1NC

**Button color**  
 Blank: Red, Green, Black, and White included  
 Y : Yellow S : Blue

**Terminals**  
 F : Finger-safe terminal (IP20)  
 C : Exposed screw terminal

Emergency Stop Switches



Part Number Structure

EU2B - YBV3 11 F R

**Operator (style / function)**  
 BV3 : 40mm mushroom/push, pull or twist release

**Contact arrangement**  
 01 : 1NC  
 11 : 1NO-1NC  
 02 : 2NC  
 03 : 3NC  
 12 : 1NO-2NC

**Button color**  
 R : Red

**Terminals**  
 F : Finger-safe terminal (IP20)  
 C : Exposed screw terminal

Note: Use only when interpreting part numbers. Do not use for developing part numbers.

Note: Use only when interpreting part numbers. Do not use for developing part numbers.

Part Number	Style and Function	Contact Arrangement	Weight (Approx.)	① Button Color
EU2B-YB110④①-D	Flush Momentary	1NO	68g	① Blank - supplied with red, green, black, and white buttons  For yellow or blue buttons, specify Y (yellow) or S (blue).
EU2B-YB101④①-D		1NC		
EU2B-YB111④①-D		1NO-1NC	92g	
EU2B-YB120④①-D		2NO		
EU2B-YB102④①-D		2NC		
EU2B-YB121④①-D		2NO-1NC		
EU2B-YB112④①-D		1NO-2NC	116g	
EU2B-YB130④①-D		3NO		
EU2B-YB103④①-D		3NC		
EU2B-YB210④①-D		Extended Momentary	1NO	
EU2B-YB201④①-D	1NC			
EU2B-YB211④①-D	1NO-1NC		94g	
EU2B-YB220④①-D	2NO			
EU2B-YB202④①-D	2NC			
EU2B-YB221④①-D	2NO-1NC			
EU2B-YB212④①-D	1NO-2NC		118g	
EU2B-YB230④①-D	3NO			
EU2B-YB203④①-D	3NC			
EU2B-YB310④①-D	1NO			76g
EU2B-YB301④①-D	1NC			
EU2B-YB311④①-D	1NO-1NC	101g		
EU2B-YB320④①-D	2NO			
EU2B-YB302④①-D	2NC			
EU2B-YB321④①-D	2NO-1NC			
EU2B-YB312④①-D	1NO-2NC	125g		
EU2B-YB330④①-D	3NO			
EU2B-YB303④①-D	3NC			

Note: ① Button Color.

Specify a contact terminal style in place of ④ in the part number: F (Finger-safe terminal), C (Exposed screw terminal)

Part Number	Operator	Contact Arrangement	Weight (Approx.)	Button Color
EU2B-YBV301④R	ø40 Mushroom	1NC	96g	R : Red
EU2B-YBV311④R		1NO-1NC		
EU2B-YBV302④R		2NC	120g	
EU2B-YBV312④R		1NO-2NC		
EU2B-YBV303④R		3NC		

Specify a terminal style in place of ④ in the part number: F (Finger-safe terminal), C (Exposed screw terminal)

Pilot Lights



Part Number Structure

EU2B - YL1 22 F D R

**Operator (style / function)**  
 L1 : Pilot Light / dome

**Lens/LED Colors**  
 R : Red G : Green A : Amber  
 Y : Yellow PW : White S : Blue

**Operating voltage**  
 126 : AC 120V (Transformer type)    66 : AC/DC 6V (Full voltage type)  
 246 : AC 240V (Transformer type)    11 : AC/DC 12V (Full voltage type)  
 386 : AC 380V (Transformer type)    22 : AC/DC 24V (Full voltage type)  
 486 : AC 480V (Transformer type)

**Terminals**  
 F : Finger-safe terminal (IP20)  
 C : Exposed screw terminal

Note: Use only when interpreting part numbers. Do not use for developing part numbers.

Part Number	Type	Operating Voltage	Weight (Approx.)	① Illumination Color Code
EU2B-YL1126④D①	Transformer	120V AC	150g	R : red G : green A : amber Y : yellow PW : white S : blue
EU2B-YL1236④D①		230V AC		
EU2B-YL1246④D①		240V AC		
EU2B-YL1386④D①		380V AC		
EU2B-YL1486④D①		480V AC		
EU2B-YL166④D①	Full Voltage	6V AC/DC	108g	
EU2B-YL111④D①		12V AC/DC		
EU2B-YL122④D①		24V AC/DC		

Note: ① Illumination Color.

Specify a contact terminal style in place of ④ in the part number: F (Finger-safe terminal), C (Exposed screw terminal)



Selector Switches



Part Number Structure

EU2B - YS 2 11 N1 F

**Operator (style / function)**  
S : Selector (Knob operator)

**Number of Positions / Spring Return Action**  
 2 : 2-position / Maintained  
 2R : 2-position / Maintained (Overlap)  
 2J : 2-position / Maintained (Special function)  
 21 : 2-position / Spring return from right  
 3 : 3-position / Maintained  
 31 : 3-position / Spring return from right  
 32 : 3-position / Spring return from left  
 33 : 3-position / Spring return two-way

**Contact arrangement**  
 10 : 1NO  
 11 : 1NO-1NC  
 01 : 1NC  
 30 : 3NO  
 20 : 2NO  
 03 : 3NC  
 02 : 2NC  
 21 : 2NO-1NC  
 12 : 1NO-2NC

**Terminals**  
 F : Finger-safe terminal (IP20)  
 C : Exposed screw terminal

**Circuit Number**  
 Blank : No Designation  
 N\* : See charts

Note: Use only when interpreting part numbers. Do not use for developing part numbers.

2-Position Selector Switches

Contact	Mounting	Operator Position		Maintained	Spring Return from Right	Weight (approx)
		L	R			
NO	1		●	EU2B-YS210④	EU2B-YS2110④	74g
		●				
NC	3	●		EU2B-YS201④	EU2B-YS2101④	74g
			●			
NO	1		●	EU2B-YS220④	EU2B-YS2120④	98g
		●				
NO	3	●		EU2B-YS202④	EU2B-YS2102④	98g
			●			
NC	1	●		EU2B-YS211④	EU2B-YS2111④	98g
			●			
NO	2		●	EU2B-YS230④	EU2B-YS2130④	122g
		●				
NO	3	●		EU2B-YS203④	EU2B-YS2103④	122g
			●			
NO	1		●	EU2B-YS221④	EU2B-YS2121④	122g
		●				
NC	2	●		EU2B-YS212④	EU2B-YS2112④	122g
			●			
NC	3	●		EU2B-YS212④	EU2B-YS2112④	122g
			●			
NO	1		●	EU2B-YS2R11④	N/A	98g
		●				
NC	2		●			

Specify a terminal style in place of ④ in the part number: F (Finger-safe terminal), C (Exposed screw terminal)

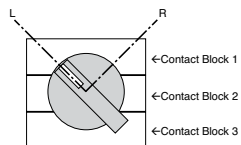

2-Position Selector Switches (Inverse Cam)

Contact	Mounting	Operator Position		Maintained	Weight (approx)
		L	R		
NO	1	●		EU2B-YS2J10④	74g
			●		
NC	3	●		EU2B-YS2J01④	74g
			●		
NO	1	●		EU2B-YS2J20④	98g
			●		
NO	3	●		EU2B-YS2J02④	98g
			●		
NC	1	●		EU2B-YS2J11④	98g
			●		
NO	2	●		EU2B-YS2J30④	122g
			●		
NO	3	●		EU2B-YS2J03④	122g
			●		
NO	1	●		EU2B-YS2J21④	122g
			●		
NC	2	●		EU2B-YS2J12④	122g
			●		
NC	3	●		EU2B-YS2J12④	122g
			●		

3-Position Selector Switches

Contact	Mounting	Operator Position			Maintained	Spring Return from Right	Spring Return from Left	Spring Return Two Way	Weight (approx)	
		L	C	R	L C R	L C R	L C R	L C R		
NO	1	●			EU2B-YS320④	EU2B-YS3120④	EU2B-YS3220④	EU2B-YS3320④	98g	
NO	3			●						
NO	2	●		●	EU2B-YS320N1④	EU2B-YS3120N1④	EU2B-YS3220N1④	EU2B-YS3320N1④		
NO	3			●						
NC	1		■		EU2B-YS302④	EU2B-YS302④	EU2B-YS3202④	EU2B-YS3302④		
NC	3	■								
NC	2		●		EU2B-YS302N1④	EU2B-YS3102N1④③	EU2B-YS3202N1④③	EU2B-YS3302N1④		
NC	3	■								
NO	1	●			EU2B-YS311④	EU2B-YS311④	EU2B-YS3211④	EU2B-YS3311④		
NC	3	■								
NC	1		■		EU2B-YS311N1④	EU2B-YS311N1④	EU2B-YS3211N1④	EU2B-YS3311N1④		
NO	3			●						
NO	1	●			EU2B-YS311N2④	EU2B-YS311N2④	EU2B-YS3211N2④	EU2B-YS3311N2④		
NC	2		●							
NC	2		●		EU2B-YS311N3④	EU2B-YS311N3①	EU2B-YS3211N3①	EU2B-YS3311N3①		
NO	3			●						
NO	2	●		●	EU2B-YS311N4④	EU2B-YS311N4④	EU2B-YS3211N4④	EU2B-YS3311N4④		
NC	3	■								
NO	1	●			EU2B-YS330④	EU2B-YS3130④	EU2B-YS3230④	EU2B-YS3330④		122g
NO	2	●		●						
NO	3			●						
NC	1		■		EU2B-YS303④	EU2B-YS3103④	EU2B-YS3203④	EU2B-YS3303④		
NC	2		●							
NC	3	■								
NO	1	●			EU2B-YS3 21N1④	EU2B-YS3121N1④	EU2B-YS3221N1④	EU2B-YS3321N1④		
NC	2		●							
NO	3			●						
NC	1		■		EU2B-YS3 12N1④	EU2B-YS3112N1④	EU2B-YS3212N1④	EU2B-YS3312N1④		
NO	2	●		●						
NC	3	■								

Specify a terminal style in place of ④ in the part number: F (Finger-safe terminal), C (Exposed screw terminal)

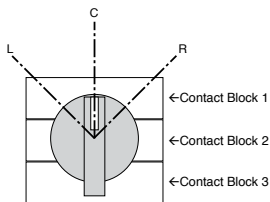

Key Selector Switches



Part Number Structure

EU2B - YSK 2 11 N1 F A

Operator (style / function)

SK: Key selector (Key operator)

Number of Positions / Spring Return Action

- 2: 2-position / Maintained
- 2R: 2-position / Maintained (Overlap)
- 2J: 2-position / Maintained (Special function)
- 21: 2-position / Spring return from right
- 3: 3-position / Maintained
- 31: 3-position / Spring return from right
- 32: 3-position / Spring return from left
- 33: 3-position / Spring return two-way

Contact arrangement

- 10: 1NO
- 11: 1NO-1NC
- 01: 1NC
- 30: 3NO
- 20: 2NO
- 03: 3NC
- 02: 2NC
- 21: 2NO-1NC
- 12: 1NO-2NC

Key Removable Position

See Key removable option codes below

Terminals

- F: Finger-safe terminal (IP20)
- C: Exposed screw terminal

Circuit Number

- Blank: No Designation
- N\*: See the following charts

Note: Use only when interpreting part numbers. Do not use for developing part numbers.

2-Position Key Selector Switches

Contact	Mounting	Operator Position		Maintained	Spring Return from Right	Weight (approx)
		L	R	L R	L R	
NO	1		●	EU2B-YSK210④③	EU2B-YSK2110④③	96g
				EU2B-YSK201④③	EU2B-YSK2101④③	
NC	3	●		EU2B-YSK220④③	EU2B-YSK2120④③	120g
			●	EU2B-YSK202④③	EU2B-YSK2102④③	
NO	1		●	EU2B-YSK211④③	EU2B-YSK2111④③	144g
				EU2B-YSK230④③	EU2B-YSK2130④③	
NC	2	●		EU2B-YSK203④③	EU2B-YSK2103④③	144g
			●	EU2B-YSK221④③	EU2B-YSK2121④③	
NO	1		●	EU2B-YSK212④③	EU2B-YSK2112④③	120g
				EU2B-YSK2R11④③	N/A	

Key is removable in all maintained positions. Specify key removal position in place of ③ in the part number. See table.

Specify a terminal style in place of ④ in the part number: F (Finger-safe terminal), C (Exposed screw terminal).

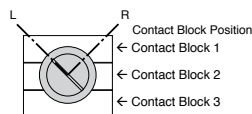

The key can be released in any maintained position.

2-Position Key Selector Switches (Inverse Cam)

Contact	Mounting	Operator Position		Maintained	Weight (approx)
		L	R	L R	
NO	1	●		EU2B-YSK2J10④③	96g
				EU2B-YSK2J01④③	
NC	3		●	EU2B-YSK2J20④③	120g
				EU2B-YSK2J02④③	
NO	1		●	EU2B-YSK2J11④③	144g
				EU2B-YSK2J30④③	
NC	2	●		EU2B-YSK2J03④③	144g
			●	EU2B-YSK2J21④③	
NO	1	●		EU2B-YSK2J12④③	144g
			●		

③ Key Removable Option Codes (2-position)

Code	Description
A	Key removable in any position
B	Key removable in left position
C	Key removable in right position

3-Position Key Selector Switches

Contact	Mounting	Operator Position			Maintained	Spring Return from Right	Spring Return from Left	Spring Return Two Way	Weight (approx)
		L	C	R	L C R	L C R	L C R	L C R	
NO	1	●			EU2B-YSK320④③	EU2B-YSK3120④③	EU2B-YSK3220④③	EU2B-YSK3320④③	120g
NO	3			●					
NO	2	●		●	EU2B-YSK320N1④③	EU2B-YSK3120N1④③	EU2B-YSK3220N1④③	EU2B-YSK3320N1④③	
NO	3			●					
NC	1		■		EU2B-YSK302④③	EU2B-YSK302④③	EU2B-YSK3202④③	EU2B-YSK3302④③	
NC	3	■							
NC	2		●		EU2B-YSK302N1④③	EU2B-YSK3102N1④③	EU2B-YSK3202N1④③	EU2B-YSK3302N1④③	
NC	3	■							
NO	1	●			EU2B-YSK311④③	EU2B-YSK311④③	EU2B-YSK3211④③	EU2B-YSK3311④③	
NC	3	■							
NC	1		■		EU2B-YSK311N1④③	EU2B-YSK311N1④③	EU2B-YSK3211N1④③	EU2B-YSK3311N1④③	
NO	3			●					
NO	1	●							
NC	2		●		EU2B-YSK311N2④③	EU2B-YSK311N2④③	EU2B-YSK3211N2④③	EU2B-YSK3311N2④③	
NC	2		●						
NO	3			●	EU2B-YSK311N3④③	EU2B-YSK311N3④③	EU2B-YSK3211N3④③	EU2B-YSK3311N3④③	
NO	3			●					
NO	2	●		●	EU2B-YSK311N4④③	EU2B-YSK311N4④③	EU2B-YSK3211N4④③	EU2B-YSK3311N4④③	
NC	3	■							
NO	1	●			EU2B-YSK330④③	EU2B-YSK3130④③	EU2B-YSK3230④③	EU2B-YSK3330④③	
NO	2	●		●					
NO	3			●					
NC	1		■		EU2B-YSK303④③	EU2B-YSK3103④③	EU2B-YSK3203④③	EU2B-YSK3303④③	
NC	2		●						
NC	3	■							
NO	1	●							
NC	2		●		EU2B-YSK321N1④③	EU2B-YSK3121N1④③	EU2B-YSK3221N1④③	EU2B-YSK3321N1④③	
NO	3			●					
NC	1		■						
NO	2	●		●	EU2B-YSK312N1④③	EU2B-YSK3112N1④③	EU2B-YSK3212N1④③	EU2B-YSK3312N1④③	
NC	3	■							

Key is removable in all maintained positions. Specify key removal position in place of ③ in the part number. See table. Specify a terminal style in place of ④ in the part number: F (Finger-safe terminal), C (Exposed screw terminal).

③ Key Removable Option Codes (3-Position)

Code	Description
A	Key removable in any position
B	Key removable in left and center positions
C	Key removable in center and right positions
D	Key removable in center position
E	Key removable in left and right positions
G	Key removable in left position
H	Key removable in right position

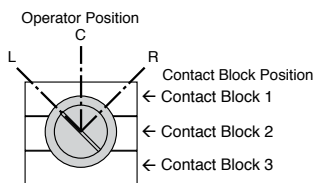

The key can be released in any maintained position.

Meters



Part Number Structure - AC Ammeter

**EU2B - YM 53 A 10 F R**

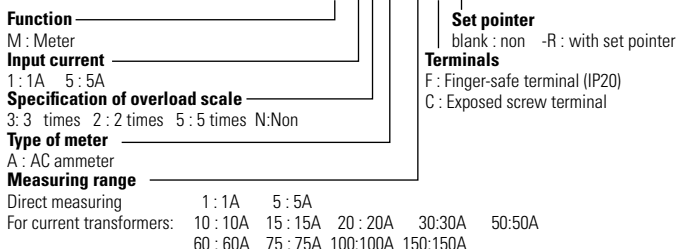

Part Number Structure - DC Ammeter or Voltmeter

**EU2B - YM 010 VD F-PER-R**

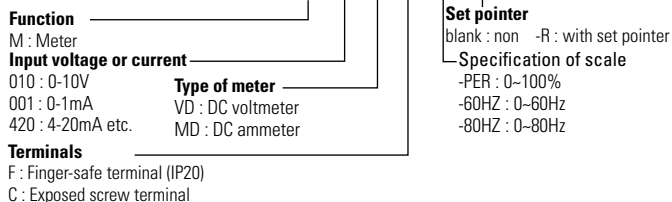

Note: Use only when interpreting part numbers. Do not use for developing part numbers.

Note: Use only when interpreting part numbers. Do not use for developing part numbers.

Input	Part Number	Description	Weight (approx.)
AC input meter (ammeter)	EU2B-YM53A5④	Capacity: 5A Expansion scale: x3	270g
	EU2B-YM53A10④	Capacity:10/5A Expansion scale: x3	
	EU2B-YM13A10④	Capacity:10/1A Expansion scale: x3	
	EU2B-YM53A15④	Capacity:15/5A Expansion scale: x3	
	EU2B-YM13A15④	Capacity:15/1A Expansion scale: x3	
	EU2B-YM13A20④	Capacity:20/1A Expansion scale: x3	
	EU2B-YM53A30④	Capacity:30/5A Expansion scale: x3	
	EU2B-YM13A30④	Capacity:30/1A Expansion scale: x3	
	EU2B-YM53A50④	Capacity:50/5A Expansion scale: x3	
	EU2B-YM53A60④	Capacity:60/5A Expansion scale: x3	
	EU2B-YM53A75④	Capacity:75/5A Expansion scale: x3	
	EU2B-YM53A100④	Capacity:100/5A Expansion scale: x3	
EU2B-YM53A150④	Capacity:150/5A Expansion scale: x3		
DC input meter	EU2B-YM010VD④-PER	0-10V DC Input Scale: 0 to 100%	270g
	EU2B-YM010VD④-60HZ	0-10V DC Input Scale: 0 to 60Hz	
	EU2B-YM001MD④-PER	0-1mA DC Input Scale: 0 to 100%	
	EU2B-YM001MD④-60HZ	0-1mA DC Input Scale: 0 to 60Hz	
	EU2B-YM001MD④-80HZ	0-1mA DC Input Scale: 0 to 80Hz	
	EU2B-YM420MD④-PER	4-20mA DC Input Scale: 0 to 100%	
	EU2B-YM420MD④-60HZ	4-20mA DC Input Scale: 0 to 60Hz	

Specify a terminal style in place of ④ in the part number: F (Finger-safe terminal), C (Exposed screw terminal)

## Dimensions

All dimensions in mm

### Pushbuttons

Shown with finger-safe contacts

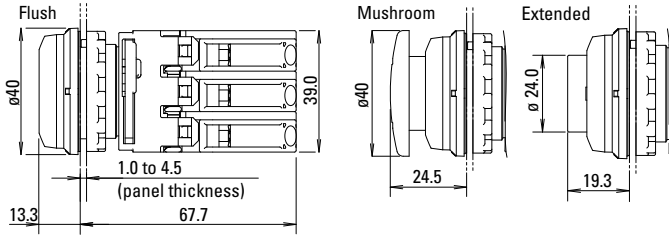
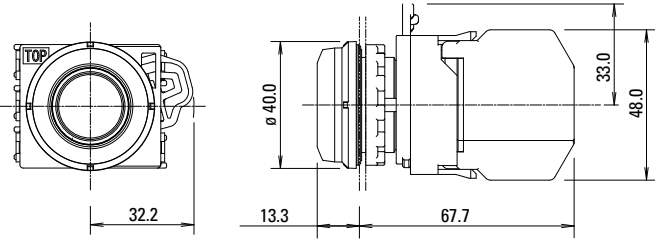

### Pilot Lights

Shown with finger-safe contacts

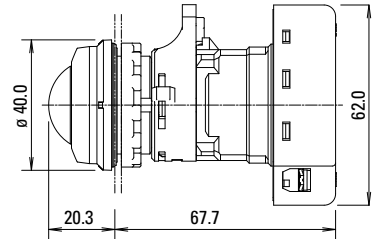
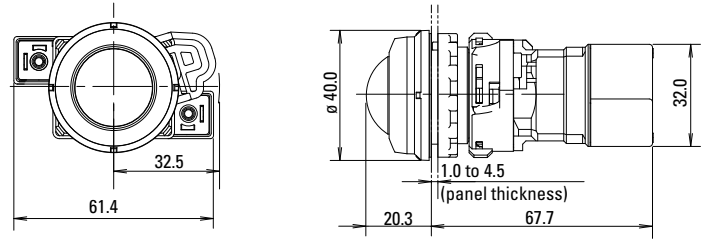

### Emergency Stop Switches

Shown with finger-safe contacts

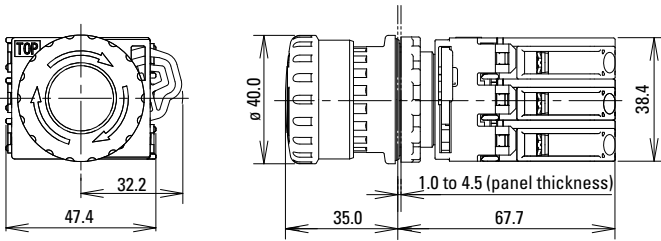

### Meters

Shown with finger-safe contacts

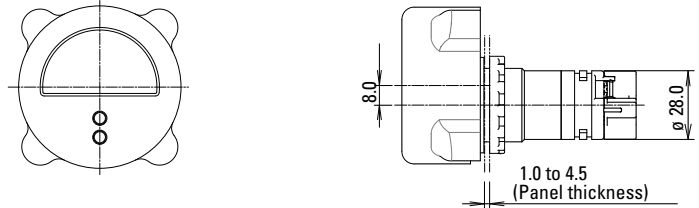

### Selector Switches

Shown with finger-safe contacts

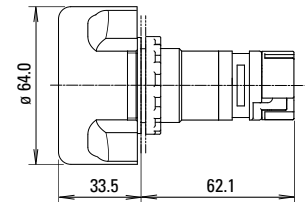
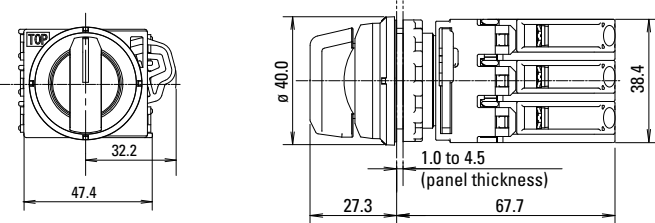

### Key Selector Switch

Shown with finger-safe contacts

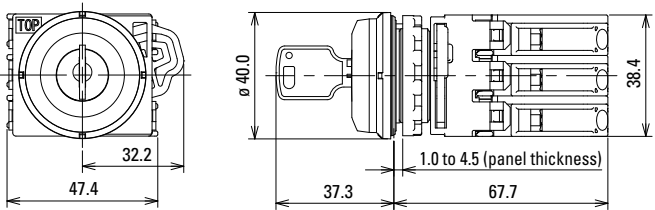

### Mounting Hole Dimensions

Panel thickness: 1.0 to 4.5 mm.

\*Note: The meter can be mounted on the top mounting holes of a standard 50mm mounting centers. The meter can be mounted on any mounting hole with a 70mm or larger mounting center.

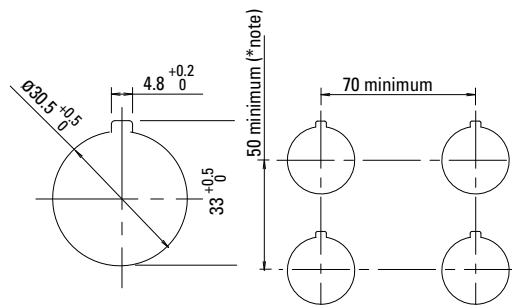

## Accessories



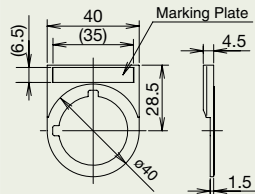

All dimensions in mm

### Nameplates

Used for pilot light, pushbutton, selector switch, and key selector switch.

Appearance	Part Number	Dimensions
	EU9Z-NM	

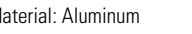
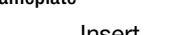
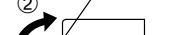
### Nameplate Inserts

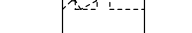
Appearance	Legend	Part Number
	Blank	EU9Z-NP0
	ON	EU9Z-NP1
	OFF	EU9Z-NP2
	START	EU9Z-NP3
	STOP	EU9Z-NP4
	OFF-ON	EU9Z-NP31
	HAND-AUTO	EU9Z-NP35
	HAND-OFF-AUTO	EU9Z-NP53

Material: Aluminum

#### Installing the Insert to the Nameplate

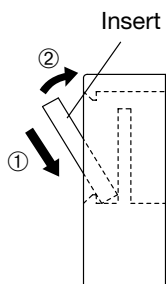



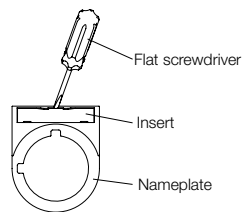

#### Removing the Insert from the Nameplate





To remove the Insert, insert a flat screwdriver between the Insert and Nameplate.

### Rubber Boots

Appearance	Description/Usage	Part Number
	For Flush Pushbuttons Not for use with name plate	EU9Z-DB1
	For Flush Pushbuttons For use with name plate	EU9Z-DB1N
	For Extended Pushbuttons Not for use with name plate	EU9Z-DB2
	For Extended Pushbuttons For use with name plate	EU9Z-DB2N

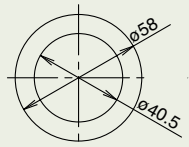
### Emergency Stop Switch Nameplate Stickers

Appearance	Legend	Part Number	Dimensions
	Blank	EU9Z-NVS0	
	Emergency Stop	EU9Z-NVS27	

Material: yellow vinyl Legend: black

### Padlock Cover

EU2B-YB2 extended pushbutton: to maintain latched status

EU2B-YB1 flush pushbutton/EU2B-YSK key selector switch: to prevent operation

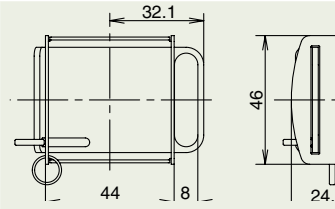
Appearance	Part Number	Dimensions
	EU9Z-PC	

Material: Stainless Steel

### Emergency Stop Switch Padlock Cover

Used with EU2B-YBV emergency stop switch to maintain the switch in the latched status.

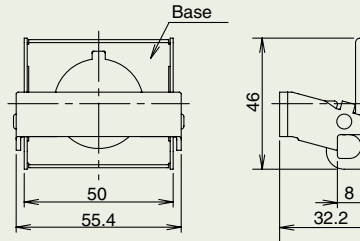
Appearance	Part Number	Dimensions
	EU9Z-PCE	

Coating: yellow Material: Stainless Steel

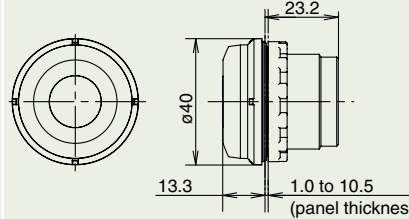

### Mounting Hole Plug

Used to plug unused mounting holes (ø30.5) on the mounting panel.

Appearance	Part Number	Dimensions / Usage
	EU9Z-BP	



**Buttons**

Appearance	Style	Part Number	Button Color Code
	Flush	HW1A-B1①	Specify a color code in place of ① in the Ordering Number. R : red G : green B : black Y : yellow W : white S : blue
	Extended	HW1A-B2①	
	ø40 Mushroom	HW1A-B4①	

Material: Polyacetal

**Lenses**

Appearance	Lens Color	Part Number
	Red	EU9Z-LR
	Green	EU9Z-LG
	Amber	EU9Z-LA
	Yellow	EU9Z-LY
	White	EU9Z-LW
	Blue	EU9Z-LS

Material: AS resin (gasket supplied)

**LED Lamps**



Operating Voltage	Current Draw		Part Number	Illumination Color Code	Base
	AC	DC			
6V AC/ DC±10%	8mA	7mA (A, R, W) 5.5mA (G, PW, S)	LSTD-6①	Specify a color code in place of ① in the part number R : red G : green A : amber PW : white S : blue Use a white (PW) LED with yellow (Y) lens.	BA9S/13
12V AC/ DC±10%	11mA	10mA	LSTD-1①		
24V AC/ DC±10%	11mA	10mA	LSTD-2①		

**Operating Instructions**

**Wiring**

**Applicable Wires**

Stranded wire: 1.5 to 2.5 mm<sup>2</sup>, solid wire: ø1.2 to ø1.6 mm (AWG16 to 14)

Note: Do not connect more than 2 wires to the same terminal.

**Applicable crimping terminal**

Ring and spade terminals cannot be used with IP20 finger-safe terminal blocks.

When connecting 2 ferrules to the EU2B control unit, use ferrules without insulating sheath.

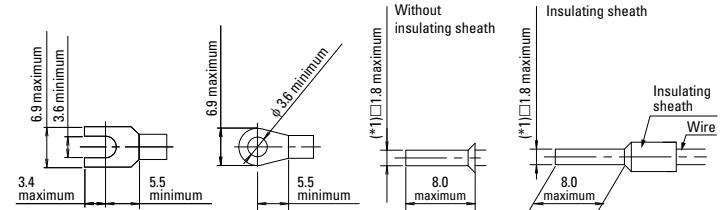

Recommended crimping terminal (WAGO)

Ferrule with insulating sheath: 216-204

Ferrule without insulating sheath: 216-104

Crimping plier: 206-204

**Recommended Tightening Torque**

EU2B control units (M3.5): 1.0 to 1.3 N·m

**Warning**

Incorrect wiring may cause fire hazard. Observe the following conditions.

- Be sure to install an insulating sheath on the crimping terminal or the crimping terminal with insulation.
- When connecting solid wires or stranded wires directly, strip the insulation, mentioned below, and insert the wire all the way in.  
EU2B Control units: 8.6 mm maximum  
Crimping terminal: 8 to 9 mm
- When using stranded wires, make sure that there are no wire whiskers.
- Make sure that the spade crimping terminals and ferrules are inserted all the way in.

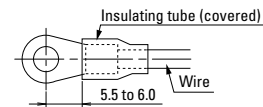

**Removing and Installing the Contact Unit / Lamp Unit**

To remove the contact unit or the lamp unit from the operator, pull the protruding yellow part of the locking lever outwards as shown in the figure below using a screwdriver, and turn it to the left. The contact unit or lamp unit can be removed.

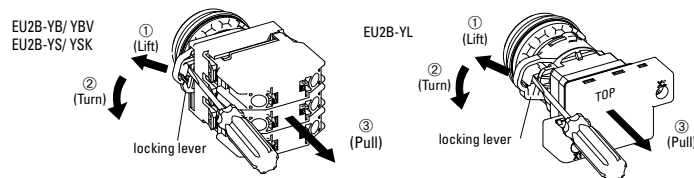

When the contact unit is removed from the emergency stop switch operator, the NO contact closes and the NC contact opens.

Do not turn the locking lever when the contact unit is removed from the operator (the red indicator is protruding out. See the figure below) or the switch can be damaged.

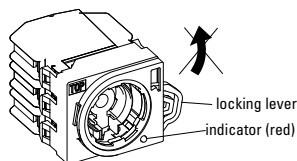

**Panel mounting for the operator, lens unit and meter**

Remove the locking ring from the operator and check that the rubber gasket is in place. Insert the operator from the panel front into the panel hole. Place the projection on the operator with TOP marking upward and the recess on the mounting panel in the same direction. (The meter has no projection.)

Tighten the locking ring using ring wrench XN9Z-T1 to a torque of 2.5 Nm. When using a nameplate or padlocking cover, install it between the operator and panel. Make sure that the groove of the nameplate or padlocking cover and the projection on the TOP marking of the operator are in the same direction.

Note: The locking ring for emergency stop switches and meter is metallic. The meter can't mount the nameplate or padlocking cover.

**Installing the contact unit and lamp unit**

To install the contact unit, place the TOP marking on the operator and the TOP marking on the contact block adapter in the same direction, and then attach the contact unit to the operator. Then turn the locking lever to the right. Follow the same procedure when installing the lamp unit.

When installing the lamp unit, check that the inner lens is not loose.

The contact block adapters for emergency stop switches cannot be used for the pushbutton, selector and key selector switches.

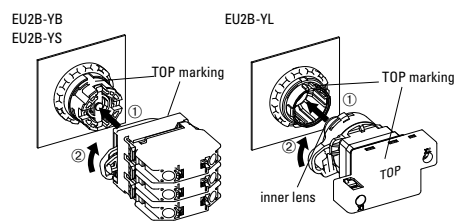
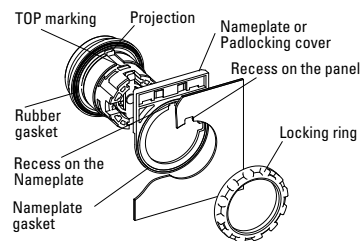

**Removing the Contact Block**

To remove the contact block, insert a flat screwdriver under the latch of the contact block adaptor and disengage the latch as shown in the figure below.

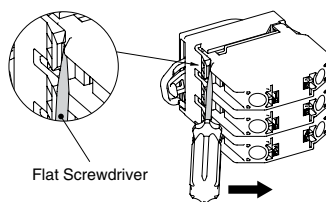

**Installing the Contact block**

When installing the contact block after maintenance or wiring, make sure that the contact configuration is correct. Installing the contact block in the incorrect position or incomplete installation may cause malfunction of the switch.

Remove the contact block from the operator before installing the contact block to the contact block adaptor. Also make sure that the contact block is correctly installed to the contact block adaptor before attaching the operator. Do not install the contact block adaptor with the operator attached. Otherwise, malfunction may result.

**Accessories**

**Padlock Cover**

The following padlocks and hasps can be used.

(Padlock Size)	a	b	c
Flush/extended pushbutton/key selector switch	ø3.5 to 7.0 mm	15 mm min.	70 mm max.
Emergency Stop Switch	ø5.5 to 7.0 mm	—	—

**Recommended Hasp**

Manufacturer	Part No.
Panduit	PSL-1, PSL-1A, PSL-1.5, PSL-1.5A, PSL-HD1
Master Lock	420, 421

Padlock and hasp are available in various shapes and sizes. Make sure that they do not interfere with the control units. Note: Not supplied by IDEC.

Keep the total weight of padlock and hasp under 1500g max, otherwise the switch may malfunction or result in failure. No vibration should be applied when padlock or hasp are installed. When padlock or hasp are disfigured, stop usage immediately.

Ensure that no shock or electric sparks are generated.

When using the plate lock padlock cover with the extended pushbutton, the switch contact may turn on/off when the cover is being installed. Ensure to provide functional safety measure to prevent unexpected startup.

When using the padlock cover on the safety-related part of the control system, observe safety standards and regulations of the relevant country or region. Also be sure to perform risk assessment before operation.

**Installing EU9Z-PC Padlock Cover**

(Flush/extended pushbutton/key selector switch)

EU9Z-PC can be installed in the following two ways.

Remove the cover in the reverse step of installing the cover. Do not install or remove the cover forcefully, or it will cause failure.

[Installation A]

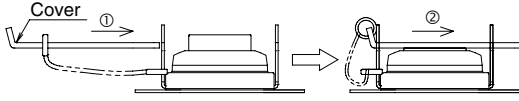

[Installation B]

This method is effective when the neighboring control unit interferes when installing in method A.

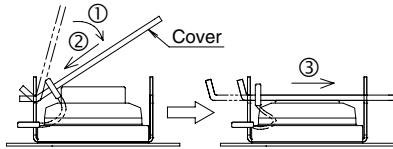

**Installing EU9Z-DB Rubber Boots**

To install the rubber boot on flush and extended pushbuttons, place the rubber boot on the cap and push the rubber boot holder straight. The notches around the rubber boot must show evenly.

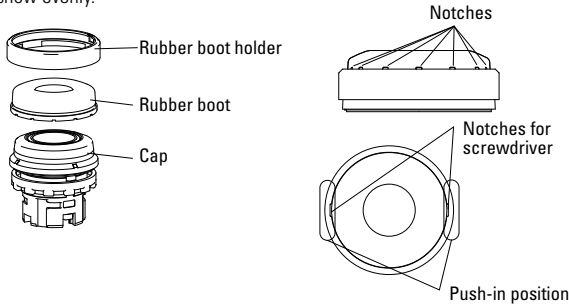

Push the rubber boot holder further around on the two notches on the holder so that the holder fits the button completely

Make sure that the rubber boot and rubber boot holder are installed straight.

On Nameplate Types, the EU2B and the rubber boot holder must be aligned so that when installed, the anti-rotation projection on the EU2B comes to the center of the groove on the holder.

Make sure that the rubber boot is installed completely, otherwise water droplets might enter the rubber boot, but no water will enter the control box.

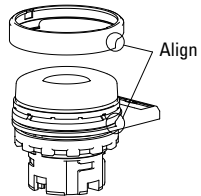

To remove the rubber boot from the flush and extended pushbuttons, gently insert the slotted screwdriver (0.5t x 4w or below) inside a notch on the rubber boot holder and tilt to the direction shown by the arrow ①. To prevent damage, do not apply excessive force to the EU2B when removing the rubber boot.

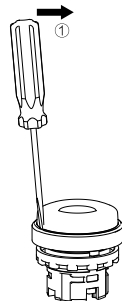

**Maintenance and Inspection**

EU2B switches should be installed in an appropriate control box.

**Maintenance and Inspection Method**

Perform daily or periodical maintenance and inspection for items such as damage and temperature rise of the EU2B switches listed in the Maintenance and Inspection table below.

**Maintenance and Inspection**

Inspection Items	Inspection Method	Inspections	Measures
Enclosure base	Visual	No rusting No damages	Cleaning Rust-resistant treatment
Tightening bolt, screws	Visual, tactile	No loosening No rusting	Tightening Cleaning
Packings	Visual	No cracks No apparent deformation	Replacement
Connecting parts	Visual, tactile	No loosening of screws No dirt on insulation materials	Tightening Cleaning
Temperature rise	Thermometer, tactile	Surface temperature 80°C max.	Investigate the cause

**Disposal**

Observe laws and regulations set by each country concerning refuse disposal.

**Safety Precautions**

Use EU2B switches that are applicable for use in hazardous areas (potentially explosive atmosphere where explosive gas or vapor may exist), otherwise explosion or fire hazard may result.

- EU2B switches can be installed only in zones 1 and 2. Do not use in zone 0.
- Turn power off to the EU2B switches before installation, removal, wiring, or maintenance, otherwise explosion, fire hazard, or electric shock may result.
- Do not disassemble, repair, or modify, otherwise damage or accident may result.
- Do not use damaged EU2B switches, otherwise damage or accident may result.
- When connecting external devices, make sure that each cable is connected to the correct terminal, otherwise electric shock, fire hazard, or explosion may result.
- Use wires of a proper size to meet voltage and current requirements. Incorrect wiring may cause abnormal temperature rise and lead to fire hazard and explosion.
- Connect the grounding terminal to a proper ground, otherwise electric shock, fire hazard, or explosion may result.
- Operate the EU2B switches at the rated current and voltage specified in this catalog, otherwise short-circuiting, fire hazard, or explosion may result.
- Stop operation immediately if abnormal operation occurs. Otherwise, a secondary accident may occur.

**CS Series – Heavy Duty Cam Switches**

**Key features:**

- Wide variety of heavy-duty oiltight cam switches
- Operators available up to 12 positions
- Switches made with a double circuit contact block
- Contact blocks rated 600V, 10A
- Ideal for ammeter/voltmeter applications
- Built to order — not available in subcomponents
- UL listed and CSA certified
- Type 4, 13



UL Listed  
File No. E68961



CSA Certified  
File No. LR48366

**Contact Ratings**

Rated Thermal Current		10A			
AC	Break Current	120V/5A	240V/3A	480V/2A	600V/1A
DC	Resistive	Break Current	24V/8A	110V/8A	220V/1A
		Break Current	24V/5A	110V/1.2A	220V/0.45A
	Inductive	Make Current (A)	Rated amperage x 1.1		
Electrical Life		500,000 operations minimum (at full rated load)			
Mechanical Life		5,000,000 (at no load)			

**CS Series**

Series	Style	Operator		Maximum Contacts To Be Mounted	Handle Styles
		Cam Angle	Position		
ACSNO		30°	Up to 12	1 to 10 decks; Up to 20 contacts	YB, SB, PB, FB
		45°	Up to 8		
		60°	Up to 6		
		90°	Up to 4		
ACSNK		30°	Up to 12	1 to 10 decks; Up to 20 contacts	HB or standard key
		45°	Up to 8		
		60°	Up to 6		
		90°	Up to 4		
UCSQO		30°	Up to 12	1 to 10 decks; Up to 20 contacts	YB, SB, PB, FB
		45°	Up to 8		
		60°	Up to 6		
		90°	Up to 4		
UCSQM		45° Spring return	Only 3	1 to 3 decks; Up to 6 contacts	YB, SB, PB, FB

1. Do not use spring return (SR) for more than six contacts.
2. Two identical keys come with ACSNK unit. Specify "H" for handle key option.
3. For handle styles, see page 758.

Switches & Pilot Devices

Signaling Lights

Relays & Sockets

Timers

Contactors

Terminal Blocks

Circuit Breakers

**Selector Switches (Assembled)**

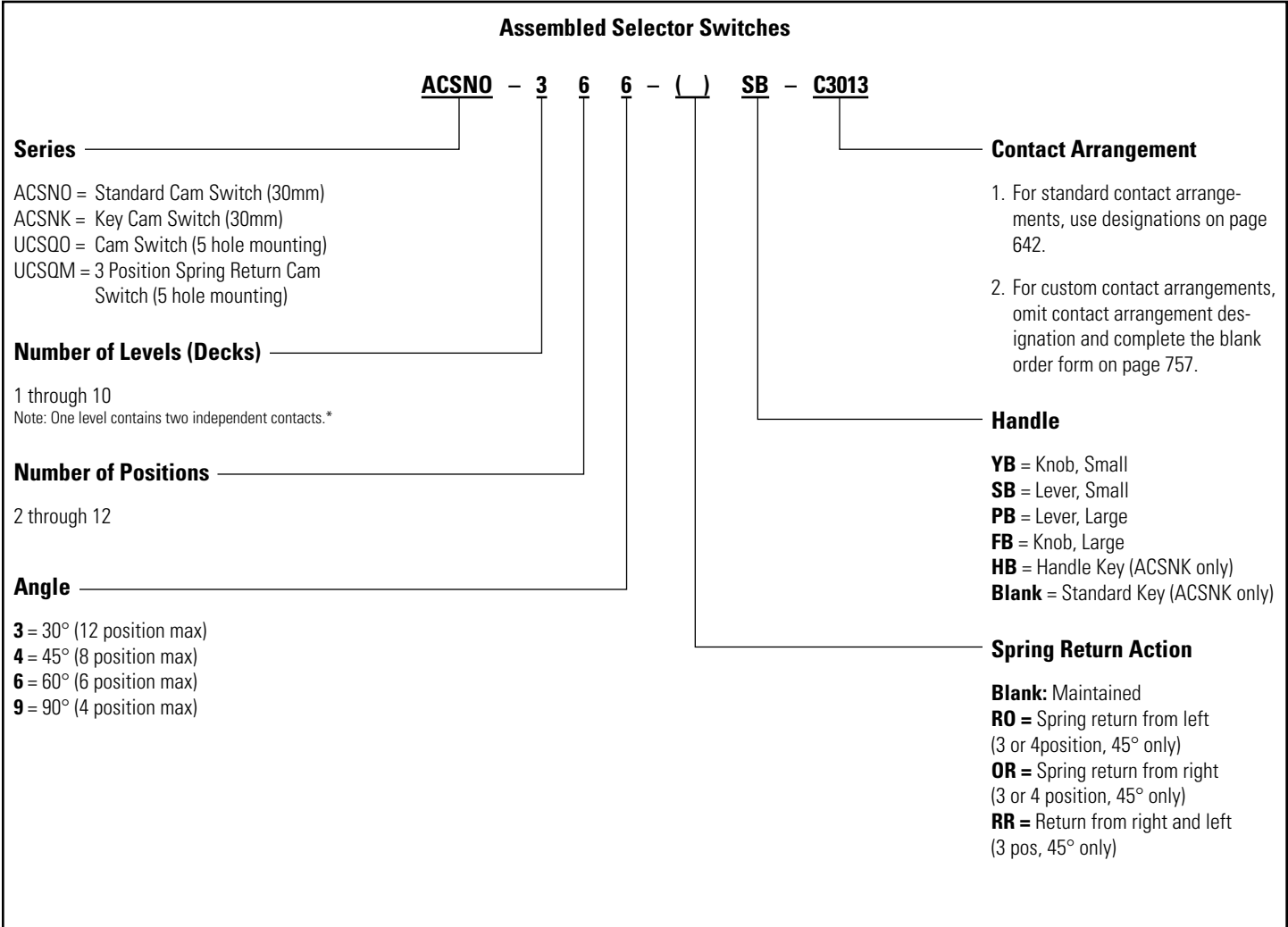

1. \*Contact blocks may contain two independent contacts, (a four position switch with four independent contacts only requires two contact blocks).  
 2. \*Caution: switches with 180° or more of rotation may require separate blocks for each contact due to cam overlapping.  
 3. Key retainable in every 45° position (45, 90, 180, 225, 270, 315, 360).

Contact Arrangements

Standard Arrangements

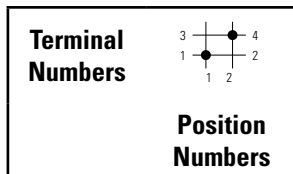

C-1001



C-1002



C-1014



C-1005

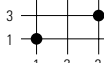

C-1008

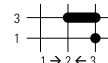

C-2001

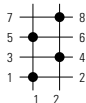

C-2002

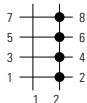

C-2006

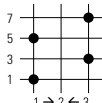

C-2004

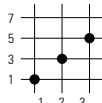

C-2008

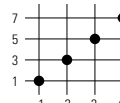

C-2009

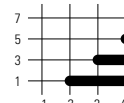

C-2027

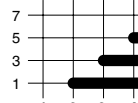

C-3001

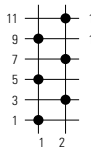

C-3002

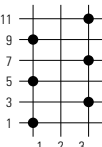

C-3005

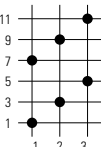

C-3013

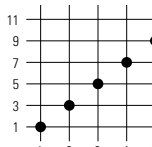

C-3016

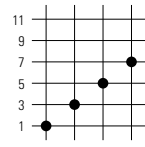

C-4001

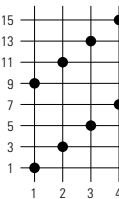

C-4002

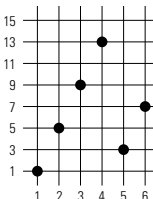

C-5001

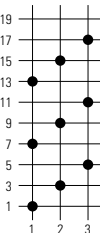

C-6001

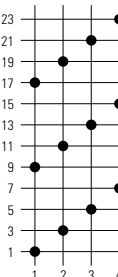

C-6002

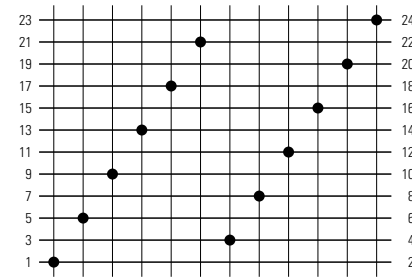

Contact Arrangements continued

Ammeter Switching

C-1012

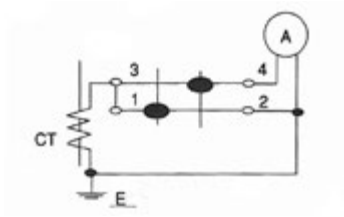

C-4007

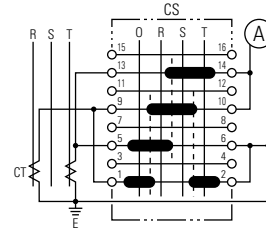

C-4003

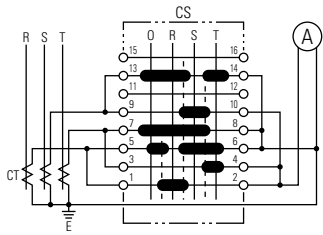

C-6003

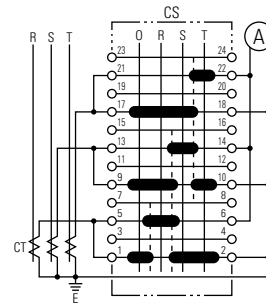

Voltmeter Switching

C-2022

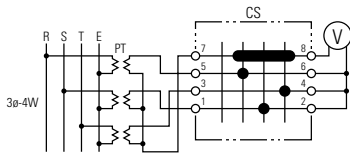

C-3008

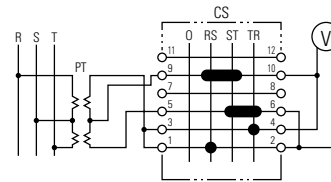

C-3009

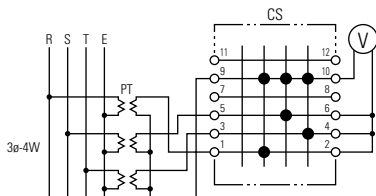

C-3007

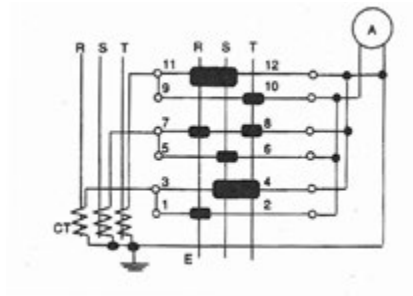



Order Form (Custom Contact Arrangement)

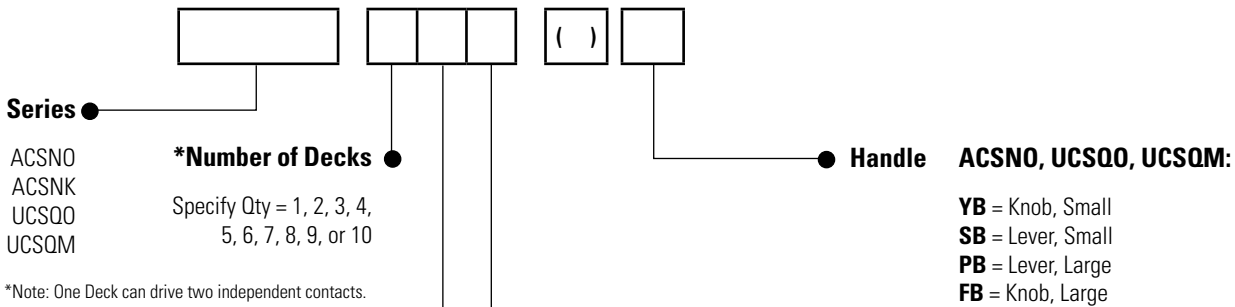

**Number of Positions**

Unit	Angle	Positions
ACSNO	30° only	9, 10, 11, 12
ACS NK*	30° or 45° only	7 or 8
UCSQO	30°, 45° or 60°	5 or 6
	30°, 45°, 60°, 90°	2, 3, or 4
UCSQM	45° only	3 only

**Spring Return**

Blank = Maintained  
**RO** = Spring return from left (3 or 4 position, 45°)  
**OR** = Spring return from right (3 or 4 position, 45°)  
**RR** = Return from right and left (3 position, 45°)

**Angle**

**3** = 30°  
**4** = 45°  
**6** = 60°  
**9** = 90°

**ACS NK:**

**HB** = Handle Key (option)  
**Blank** = Standard Key

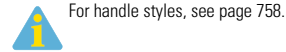

\* ACS NK keys only remove at 45°.

**UCSQM is available in spring-return version only.**

Contact Arrangement Table

Cams	Terminal Numbers	Position											
		1	2	3	4	5	6	7	8	9	10	11	12
Deck 1	1 and 2												
	3 and 4												
Deck 2	5 and 6												
	7 and 8												
Deck 3	9 and 10												
	11 and 12												
Deck 4	13 and 14												
	15 and 16												
Deck 5	17 and 18												
	19 and 20												
Deck 6	21 and 22												
	23 and 24												
Deck 7	25 and 26												
	27 and 28												
Deck 8	29 and 30												
	31 and 32												
Deck 9	33 and 34												
	35 and 36												
Deck 10	37 and 38												
	39 and 40												

To specify non-standard arrangements (designation not on preceding pages), fill in this table using the following symbols.  
**X** = Closed contact (break before make) **O** = Open contact **X-X** = Overlapping contact (remain on when switch is moved between two positions)

Specifying Nameplate (Optional)

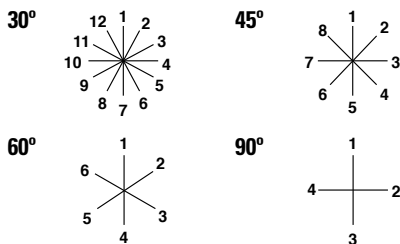

Specifying Legends

Position

1 \_\_\_\_\_  
 2 \_\_\_\_\_  
 3 \_\_\_\_\_  
 4 \_\_\_\_\_  
 5 \_\_\_\_\_  
 6 \_\_\_\_\_

If no engraving information is provided, a blank nameplate will be supplied.

1 \_\_\_\_\_  
 2 \_\_\_\_\_  
 3 \_\_\_\_\_  
 4 \_\_\_\_\_  
 5 \_\_\_\_\_  
 6 \_\_\_\_\_

**Accessories — CS Series**

**Replacement Handles**



					
Part Number	CSH-YB	CSH-SB	CSH-PB	CSH-FB	CSH-H2B
Dimensions	0.79"D x 1.61"H	0.79"D x 1.97"H	1.58"D x 1.97"H	1.58"D x Ø 1.97"	0.95"D x 2.28"H
Applicable Models	ACSNO, UCSQO, UCSQM				ACSNK

**Replacement Nameplates**

Size & Shape □ 2.52" (64mm) Black Aluminum			
Part Number	CQ	CQM	CQN
Applicable Models	UCSQO	UCSQM	ACSNO, ACSNK

- 1. Extra cost for engraving, 3/16" min. letter height, Legends maximum ten characters.
- 2. Blank nameplates are supplied with all cam switches (they need not be ordered separately).

**Wiring Clips**

Part Number	Contact Block Jumpers
CJ-1 	Between decks
CJ-2 	Same deck

**Replacement Keys**

Part Number	Description
K301 	Pair of keys (#301)

Dimensions/Terminal Arrangements/Mounting Holes

ACSNO

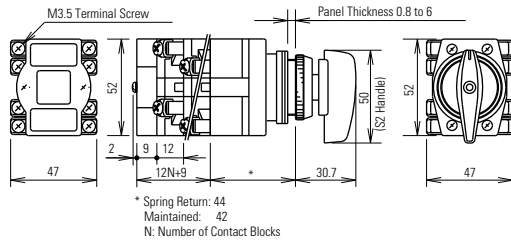

ACSNK

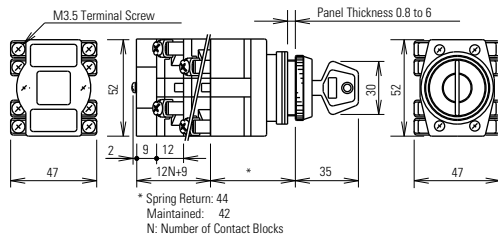

UCSQO

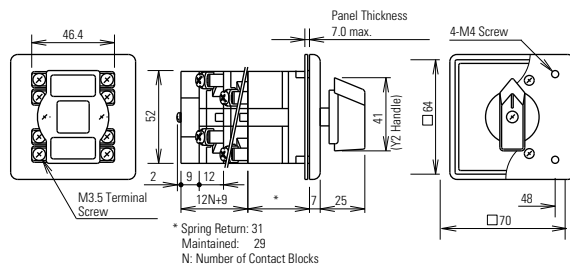

UCSQM

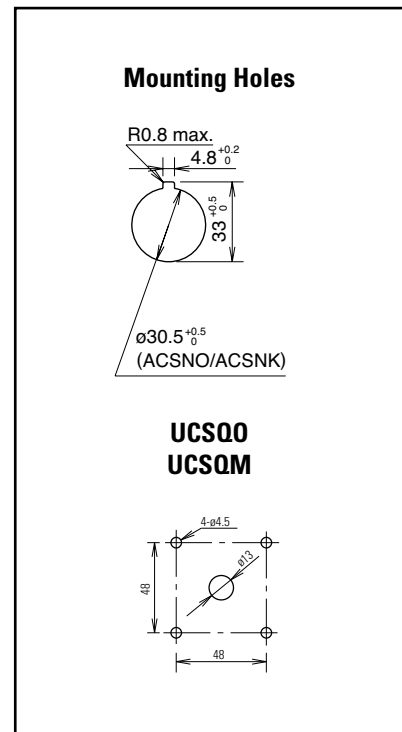
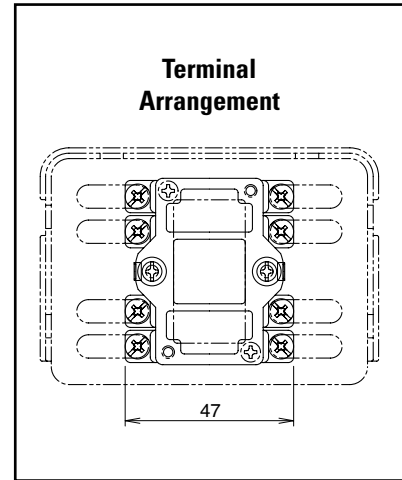
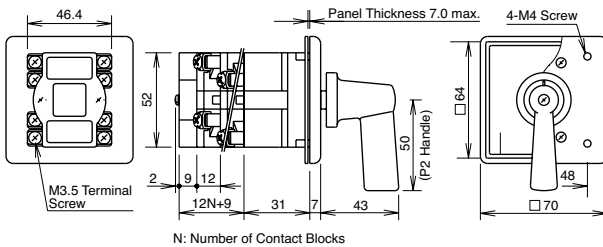

## ARN Series – Mono-Lever Switches

### Key features:

- Mono-Lever Switches Ø 1-13/64" (30mm)
- Contact Blocks Rated for 600V, 10A
- Available in 2-, 3-, and 4-positions.
- Maintained and spring-return modes available.
- Models available with interlock mechanism to prevent inadvertent actuation.



### Specifications

Operating Temperature	-25° to 50°C (without freezing)	
Insulation Resistance	100MΩ	
Contact Rating	Rated Voltage: Current	110VDC: 3A
		24V AC/DC: 10A
		120VAC: 10A
		240VAC: 6A
		480VAC: 2A
		600VAC: 1A
	Insulation Voltage	600V AC/DC
	Rated Thermal Current	10A
	Electrical Life	Over 500,000 operations

### Part Numbering Guide (Assembled)

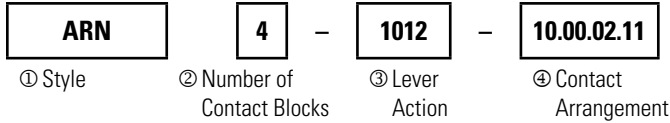

	Description	Code	Remarks
① Style	Standard Lever	ARN	Interlocking lever prevents inadvertent operation.
	Short Lever	ARNS	
	Interlocking Lever	ARNL	
② No. of Contact Blocks	—	1	Each contact block contains two independent contacts.
		2	
		3	
		4	
③ Lever Action	Blocked	0	Specify in this order: Up.Right.Down.Left
	Maintained	1	
	Spring Return	2	
④ Contact Arrangement	No contacts	00	Specify the number of contacts to be activated in all active (non-blocked) positions: Up.Right.Down.Left For blocked positions use code: 00
	1 NO contact	10	
	1 NC contact	01	
	1 NO and 1 NC contact	11	
	2 NO contacts	20	

**Mono-Lever Switches (Sub-Assembled)**

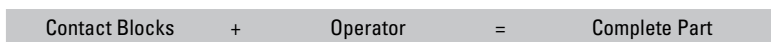

**Standard Mono-Lever Operators**

Style	Lever Operation Mode	Part Number
Standard Lever	2-Position manual return	ARNO-1010-B
	3-Position manual return	ARNO-1110-B
	4-Position manual return	ARNO-1111-B
	2-Position spring return	ARNO-2020-B
	3-Position spring return	ARNO-2220-B
	4-Position spring return	ARNO-2222-B
Short Lever	2-Position manual return	ARNSO-1010-B
	3-Position manual return	ARNSO-1110-B
	4-Position manual return	ARNSO-1111-B
	2-Position spring return	ARNSO-2020-B
	3-Position spring return	ARNSO-2220-B
	4-Position spring return	ARNSO-2222-B
Interlocking Lever	2-Position manual return	ARNLO-1010-B
	3-Position manual return	ARNLO-1110-B
	4-Position manual return	ARNLO-1111-B
	2-Position spring return	ARNLO-2020-B
	3-Position spring return	ARNLO-2220-B
	4-Position spring return	ARNLO-2222-B

**Contact Blocks**

Style	Contact Arrangement	Part Number
	2NO contacts 1NO & 1NC contact 2NC contacts 1NO early make contact	BR-1E BR-2E BR-3E BR-1EM



To calculate the number of contact blocks required, add the number of NO and NC contacts on each pair of adjoining positions (up + right, right + down, down + left, and left + up). The largest of the four sums is the number of contact blocks required. Up to four contact blocks can be mounted.

**Replacement Parts**

Style	Part Number
Bellows	ARNO, ARNSO (standard & short lever) ARN-BL
	ARNLO (Interlocking) ARNL-BL (comes in 2 pieces)
Knob (ball)	All Models Knob (ball) ARNB-B

Dimensions — ARN Series

ARNO

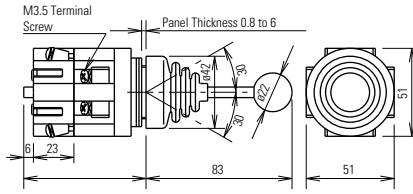

1 block: 47, 2 blocks: 70  
3 blocks: 93, 4 blocks: 116

ARNSO

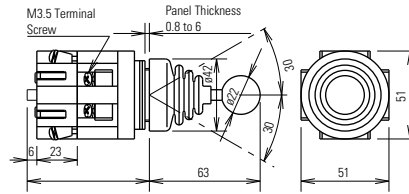

1 block: 47, 2 blocks: 70  
3 blocks: 93, 4 blocks: 116

ARNLO

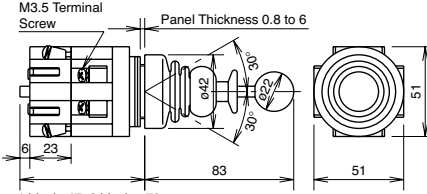

1 block: 47, 2 blocks: 70  
3 blocks: 93, 4 blocks: 116

ARNO  
ARNSO  
ARNLO

